

This PDF is available at <http://nap.edu/22914>

SHARE    

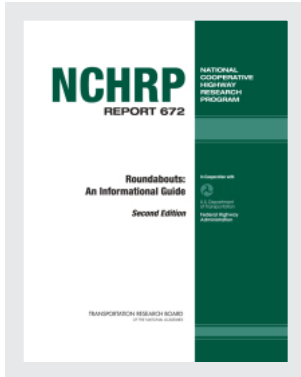

Roundabouts: An Informational Guide Second Edition (2010)

DETAILS

396 pages | 8.5 x 11 | PAPERBACK
ISBN 978-0-309-15511-3 | DOI 10.17226/22914

CONTRIBUTORS

National Cooperative Highway Research Program; Transportation Research Board; National Academies of Sciences, Engineering, and Medicine

SUGGESTED CITATION

National Academies of Sciences, Engineering, and Medicine 2010. *Roundabouts: An Informational Guide Second Edition*. Washington, DC: The National Academies Press. <https://doi.org/10.17226/22914>.

GET THIS BOOK

FIND RELATED TITLES

Visit the National Academies Press at NAP.edu and login or register to get:

- Access to free PDF downloads of thousands of scientific reports
- 10% off the price of print titles
- Email or social media notifications of new titles related to your interests
- Special offers and discounts



Distribution, posting, or copying of this PDF is strictly prohibited without written permission of the National Academies Press. (Request Permission) Unless otherwise indicated, all materials in this PDF are copyrighted by the National Academy of Sciences.

Copyright © National Academy of Sciences. All rights reserved.

NATIONAL COOPERATIVE HIGHWAY RESEARCH PROGRAM

NCHRP REPORT 672

**Roundabouts:
An Informational Guide**

Second Edition

**Lee Rodegerdts, Justin Bansen, Christopher Tiesler,
Julia Knudsen, and Edward Myers**
KITTELSON & ASSOCIATES, INC.
Portland, OR

Mark Johnson
MTJ ENGINEERING, INC.
Madison, WI

Michael Moule
LIVABLE STREETS INC.
Tampa, FL

Bhagwant Persaud and Craig Lyon
PERSAUD AND LYON
Toronto, ON, Canada

Shauna Hallmark and Hillary Isebrands
CENTER FOR TRANSPORTATION RESEARCH AND EDUCATION
IOWA STATE UNIVERSITY
Ames, IA

R. Barry Crown
RODEL SOFTWARE LTD
United Kingdom

Bernard Guichet
CETE L'OUEST
France

Andrew O'Brien
O'BRIEN TRAFFIC
Australia

Subscriber Categories
Highways • Design

Research sponsored by the American Association of State Highway and Transportation Officials
in cooperation with the Federal Highway Administration

TRANSPORTATION RESEARCH BOARD

WASHINGTON, D.C.
2010
www.TRB.org

NATIONAL COOPERATIVE HIGHWAY RESEARCH PROGRAM

Systematic, well-designed research provides the most effective approach to the solution of many problems facing highway administrators and engineers. Often, highway problems are of local interest and can best be studied by highway departments individually or in cooperation with their state universities and others. However, the accelerating growth of highway transportation develops increasingly complex problems of wide interest to highway authorities. These problems are best studied through a coordinated program of cooperative research.

In recognition of these needs, the highway administrators of the American Association of State Highway and Transportation Officials initiated in 1962 an objective national highway research program employing modern scientific techniques. This program is supported on a continuing basis by funds from participating member states of the Association and it receives the full cooperation and support of the Federal Highway Administration, United States Department of Transportation.

The Transportation Research Board of the National Academies was requested by the Association to administer the research program because of the Board's recognized objectivity and understanding of modern research practices. The Board is uniquely suited for this purpose as it maintains an extensive committee structure from which authorities on any highway transportation subject may be drawn; it possesses avenues of communications and cooperation with federal, state and local governmental agencies, universities, and industry; its relationship to the National Research Council is an insurance of objectivity; it maintains a full-time research correlation staff of specialists in highway transportation matters to bring the findings of research directly to those who are in a position to use them.

The program is developed on the basis of research needs identified by chief administrators of the highway and transportation departments and by committees of AASHTO. Each year, specific areas of research needs to be included in the program are proposed to the National Research Council and the Board by the American Association of State Highway and Transportation Officials. Research projects to fulfill these needs are defined by the Board, and qualified research agencies are selected from those that have submitted proposals. Administration and surveillance of research contracts are the responsibilities of the National Research Council and the Transportation Research Board.

The needs for highway research are many, and the National Cooperative Highway Research Program can make significant contributions to the solution of highway transportation problems of mutual concern to many responsible groups. The program, however, is intended to complement rather than to substitute for or duplicate other highway research programs.

NCHRP REPORT 672

Project 3-65A
ISSN 0077-5614
ISBN 978-0-309-15511-3
Library of Congress Control Number 2010937912

© 2010 National Academy of Sciences. All rights reserved.

COPYRIGHT INFORMATION

Authors herein are responsible for the authenticity of their materials and for obtaining written permissions from publishers or persons who own the copyright to any previously published or copyrighted material used herein.

Cooperative Research Programs (CRP) grants permission to reproduce material in this publication for classroom and not-for-profit purposes. Permission is given with the understanding that none of the material will be used to imply TRB, AASHTO, FAA, FHWA, FMCSA, FTA, or Transit Development Corporation endorsement of a particular product, method, or practice. It is expected that those reproducing the material in this document for educational and not-for-profit uses will give appropriate acknowledgment of the source of any reprinted or reproduced material. For other uses of the material, request permission from CRP.

NOTICE

The project that is the subject of this report was a part of the National Cooperative Highway Research Program, conducted by the Transportation Research Board with the approval of the Governing Board of the National Research Council.

The members of the technical panel selected to monitor this project and to review this report were chosen for their special competencies and with regard for appropriate balance. The report was reviewed by the technical panel and accepted for publication according to procedures established and overseen by the Transportation Research Board and approved by the Governing Board of the National Research Council.

The opinions and conclusions expressed or implied in this report are those of the researchers who performed the research and are not necessarily those of the Transportation Research Board, the National Research Council, or the program sponsors.

The Transportation Research Board of the National Academies, the National Research Council, and the sponsors of the National Cooperative Highway Research Program do not endorse products or manufacturers. Trade or manufacturers' names appear herein solely because they are considered essential to the object of the report.

Published reports of the

NATIONAL COOPERATIVE HIGHWAY RESEARCH PROGRAM

are available from:

Transportation Research Board
Business Office
500 Fifth Street, NW
Washington, DC 20001

and can be ordered through the Internet at:

<http://www.national-academies.org/trb/bookstore>

Printed in the United States of America

THE NATIONAL ACADEMIES

Advisers to the Nation on Science, Engineering, and Medicine

The **National Academy of Sciences** is a private, nonprofit, self-perpetuating society of distinguished scholars engaged in scientific and engineering research, dedicated to the furtherance of science and technology and to their use for the general welfare. On the authority of the charter granted to it by the Congress in 1863, the Academy has a mandate that requires it to advise the federal government on scientific and technical matters. Dr. Ralph J. Cicerone is president of the National Academy of Sciences.

The **National Academy of Engineering** was established in 1964, under the charter of the National Academy of Sciences, as a parallel organization of outstanding engineers. It is autonomous in its administration and in the selection of its members, sharing with the National Academy of Sciences the responsibility for advising the federal government. The National Academy of Engineering also sponsors engineering programs aimed at meeting national needs, encourages education and research, and recognizes the superior achievements of engineers. Dr. Charles M. Vest is president of the National Academy of Engineering.

The **Institute of Medicine** was established in 1970 by the National Academy of Sciences to secure the services of eminent members of appropriate professions in the examination of policy matters pertaining to the health of the public. The Institute acts under the responsibility given to the National Academy of Sciences by its congressional charter to be an adviser to the federal government and, on its own initiative, to identify issues of medical care, research, and education. Dr. Harvey V. Fineberg is president of the Institute of Medicine.

The **National Research Council** was organized by the National Academy of Sciences in 1916 to associate the broad community of science and technology with the Academy's purposes of furthering knowledge and advising the federal government. Functioning in accordance with general policies determined by the Academy, the Council has become the principal operating agency of both the National Academy of Sciences and the National Academy of Engineering in providing services to the government, the public, and the scientific and engineering communities. The Council is administered jointly by both the Academies and the Institute of Medicine. Dr. Ralph J. Cicerone and Dr. Charles M. Vest are chair and vice chair, respectively, of the National Research Council.

The **Transportation Research Board** is one of six major divisions of the National Research Council. The mission of the Transportation Research Board is to provide leadership in transportation innovation and progress through research and information exchange, conducted within a setting that is objective, interdisciplinary, and multimodal. The Board's varied activities annually engage about 7,000 engineers, scientists, and other transportation researchers and practitioners from the public and private sectors and academia, all of whom contribute their expertise in the public interest. The program is supported by state transportation departments, federal agencies including the component administrations of the U.S. Department of Transportation, and other organizations and individuals interested in the development of transportation. www.TRB.org

www.national-academies.org

COOPERATIVE RESEARCH PROGRAMS

CRP STAFF FOR NCHRP REPORT 672

Christopher W. Jenks, *Director, Cooperative Research Programs*
Crawford F. Jencks, *Deputy Director, Cooperative Research Programs*
B. Ray Derr, *Senior Program Officer*
Eileen P. Delaney, *Director of Publications*
Doug English, *Editor*

NCHRP PROJECT 3-65A PANEL

Field of Traffic—Area of Operations and Control

Beatriz Caicedo-Maddison, *Florida DOT, Ft. Lauderdale, FL (Chair)*
Robert R. Limoges, *New York State DOT, Albany, NY*
Maria G. Burke, *Texas DOT, Austin, TX*
Jerry Champa, *California DOT, Sacramento, CA*
Leonard Evans, *Science Serving Society, Bloomfield Hills, MI*
Steve King, *Kansas DOT, Topeka, KS*
Richard Long, *Western Michigan University, Kalamazoo, MI*
Richard Retting, *Sam Schwartz Engineering, Arlington, VA*
Edward R. Stollof, *Institute of Transportation Engineers, Washington, DC*
Brian J. Walsh, *Washington State DOT, Olympia, WA*
Mohsin A. Zaidi, *Virginia DOT, Chantilly, VA*
Joe Bared, *FHWA Liaison*
Richard A. Cunard, *TRB Liaison*

FOREWORD

By **B. Ray Derr**

Staff Officer

Transportation Research Board

This report updates the FHWA's *Roundabouts: An Informational Guide* based on experience gained in the United States since that guide was published in 2000. The report addresses the planning, design, construction, maintenance, and operation of roundabouts. It also includes information that will be useful in explaining to the public the trade-offs associated with roundabouts.

In 2000, the FHWA published *Roundabouts: An Informational Guide*. *NCHRP Synthesis 264: Modern Roundabout Practice in the United States* estimated that there were 38 modern roundabouts (i.e., those consistent with current international practice) as of October 1997. Since U.S. experience was limited, the FHWA Roundabout Guide was based largely on European and Australian guidelines.

Publication of the FHWA Roundabout Guide has fostered acceptance of the roundabout as a viable alternative for intersection design, leading to more than 2,000 roundabouts across the United States. Extensive use of the Roundabout Guide and completion of national and state research efforts identified many possible improvements. Recognizing this, the NCHRP and the FHWA jointly funded an NCHRP project to update the Roundabout Guide.

In NCHRP Project 3-65A, Kittelson & Associates, Inc., reviewed the literature and research conducted since the publication of the FHWA Roundabout Guide. They then conducted focus groups of practitioners to identify concerns with the original guide and ideas for improvements. After achieving consensus with the project oversight panel on an outline, they developed the new guide and refined it through an extensive review process.

The Second Edition of *Roundabouts: An Informational Guide* will be useful to anyone interested in evaluating or building a roundabout. The experience of the research team, coupled with the extensive review, has led to an authoritative, but not prescriptive, guide on roundabouts.

AUTHOR ACKNOWLEDGMENTS

This guide was developed through the National Cooperative Highway Research Program Project 03-65A, Update of FHWA's *Roundabouts: An Informational Guide*. The international project team consisted of Lee Rodegerdts (principal investigator), Justin Bansen, Julia Knudsen, Christopher Tiesler, and Edward Myers, Kittelson & Associates, Inc. (prime contractor); Mark Johnson, MTJ Engineering; Michael Moule, Livable Streets Inc.; Bhagwant Persaud and Craig Lyon, Persaud and Lyon; and Shauna Hallmark and Hillary Isebrands, Center for Transportation Research and Education, Iowa State University. In addition, the team had three international advisors: R. Barry Crown (United Kingdom), Bernard Guichet (France), and Andrew O'Brien (Australia). Ralph Bentley, John Henriksen, Jon Sommerville, and Bonnie Middleton of Kittelson & Associates, Inc., assisted with exhibits and production.

The authors thank each of the panel members for their diligence in providing quality direction and review throughout the project. Additional review was provided by Carl Andersen, FHWA; Mark Lenters, Ourston Roundabout Engineering; Howard McCulloch, New York State Department of Transportation; Patrick McGrady, Reid Middleton; and Eugene Russell, Kansas State University.

The authors also profoundly thank the authors and reviewers of the first edition, which formed the foundation for this document. The first edition of this guide was groundbreaking in many ways, particularly in combining many of the best roundabout practices from around the world with principles, techniques, and policies in place in the United States. Without the collaborative work of this group, this second edition would not be possible. The acknowledgments that were intended to be published with the first edition are included below.

ACKNOWLEDGMENTS FROM FIRST EDITION

This guide was developed as part of the Federal Highway Administration project DTFH61-97-R-0038. The international project team consisted of Kittelson & Associates, Inc. (prime contractor) in association with Rod Troutbeck of the Queensland University of Technology (Australia); Werner Brilon and Lothar Bondzio of Ruhr-University Bochum (Germany); Ken Courage of the University of Florida; Michael Kyte of the University of Idaho; John Mason and Aimee Flannery of Pennsylvania State University; Edward Myers of Hurst-Rosche Engineers; Jonathan Bunker of Eppell Olsen & Partners (Australia); and Georges Jacquemart of Buckhurst Fish and Jacquemart. Michael Ronkin and Thomas Ronkin provided translation of the French guides for urban roundabouts, rural roundabouts, and roundabout lighting.

Bruce Robinson was the principal investigator for Kittelson & Associates, Inc. Co-investigators were Lee Rodegerdts and Wade Scarbrough. Wayne Kittelson was the project principal. Paul Ryus and Christoff Krogscheepers assisted with review, editing, and production. Ralph Bentley and John Henriksen assisted with exhibits and production.

Joe G. Bared was the technical representative for the Federal Highway Administration at the Turner-Fairbank Highway Research Center.

The project advisory panel consisted of John Sacksteder of the Kentucky Department of Transportation and AASHTO (Geometric Design Committee); Larry Sutherland of the Ohio Department of Transportation and AASHTO (Geometric Design Committee); Mike Neiderhauser of the Maryland State Highway Administration; Michael Thomas of the California Department of Transportation; and Leif Ourston of Ourston & Doctors, Inc. Several FHWA advisors as well as many other reviewers represented various departments, including Raymond Krammes, Davey Warren, Bill Prosser, Carol Tan-Esse, Rudolph Umb, Janet Coleman, Ernest Huckaby, and John Fegan.

In addition, we are indebted to many individuals, organizations, and committees, too numerous to name, who provided voluminous comments on draft versions of the guide. In particular, the extraordinary efforts of the following contributors are acknowledged: Barry Crown (United Kingdom); Owen Arndt of the Main Roads Department of Queensland (Australia); Bernard Guichet (France); Michael Moule, formerly of the City of Asheville, North Carolina; and Lois Thibault of the U.S. Access Board.

P R E F A C E

Roundabouts are a common form of intersection control used throughout the world and increasingly in the United States. The information supplied in this document builds extensively on the first edition published in 2000 by the Federal Highway Administration and is based on established and emerging U.S. practices and recent research. The guide continues to be comprehensive in recognition of the diverse needs of transportation professionals and the public for introductory material, planning and design guidance, operational and safety performance evaluation techniques, construction and maintenance information, and the wide range of potential applications of roundabouts.

Selection and design of a roundabout, as with any intersection treatment, requires the balancing of competing objectives. These range from transportation-oriented objectives like safety, operational performance, and accessibility for all users to other factors such as economics, land use, aesthetics, and environmental aspects. Sufficient flexibility is provided to encourage independent designs and techniques tailored to particular situations while emphasizing performance-based evaluation of those designs.

Since there is no absolutely optimum design, this guide is not intended as an inflexible rule book but rather attempts to explain some principles of good design and indicate potential trade-offs that one may face in a variety of situations. In this respect, the principles and techniques in this document must be combined with the judgment and expertise of engineers, planners, and other professionals. Adherence to these principles still does not ensure good design, which remains the responsibility of the professionals in charge of the work.

Much as one cannot become a master chef merely by reading cookbooks, one cannot become a master roundabout planner or engineer solely by reading this guide. However, professionals can combine the principles in this guide with their own experiences and judgment and with the continually growing wealth of experience in our respective professions to produce favorable outcomes that benefit the traveling public and our communities.

Lee A. Rodegerdts, P.E.
Principal Investigator

CONTENTS

1-1 Chapter 1 Introduction

- 1-3 1.1 Introduction
- 1-3 1.2 Distinguishing Characteristics of a Roundabout
- 1-10 1.3 Categories of Roundabouts
- 1-17 1.4 Scope of the Guide
- 1-17 1.5 Organization of the Guide
- 1-19 1.6 References

2-1 Chapter 2 Roundabout Considerations

- 2-3 2.1 Introduction
- 2-3 2.2 General Characteristics
- 2-13 2.3 User Considerations
- 2-21 2.4 Policy and Legal Issues
- 2-22 2.5 References

3-1 Chapter 3 Planning

- 3-4 3.1 Introduction
- 3-5 3.2 Planning Steps
- 3-6 3.3 Considerations of Context
- 3-10 3.4 Potential Applications
- 3-20 3.5 Planning-Level Sizing and Space Requirements
- 3-30 3.6 Comparing Performance of Alternative Intersection Types
- 3-33 3.7 Economic Evaluation
- 3-38 3.8 Public Involvement
- 3-45 3.9 References

4-1 Chapter 4 Operational Analysis

- 4-3 4.1 Introduction
- 4-3 4.2 Principles
- 4-6 4.3 Data Collection and Analysis
- 4-10 4.4 Analysis Techniques
- 4-10 4.5 Highway Capacity Manual Method
- 4-18 4.6 Deterministic Software Methods
- 4-19 4.7 Simulation Methods
- 4-20 4.8 References

5-1 Chapter 5 Safety

- 5-4 5.1 Introduction
- 5-5 5.2 Principles
- 5-14 5.3 Observed Safety Performance
- 5-22 5.4 Intersection-Level Crash Prediction Methodology
- 5-28 5.5 Approach-Level Crash Prediction Methodology
- 5-34 5.6 References

6-1	Chapter 6 Geometric Design
6-6	6.1 Introduction
6-8	6.2 Principles and Objectives
6-16	6.3 Size, Position, and Alignment of Approaches
6-22	6.4 Single-Lane Roundabouts
6-33	6.5 Multilane Roundabouts
6-45	6.6 Mini-Roundabouts
6-53	6.7 Performance Checks
6-67	6.8 Design Details
6-90	6.9 Closely Spaced Roundabouts
6-91	6.10 Interchanges
6-95	6.11 Access Management
6-98	6.12 Staging of Improvements
6-102	6.13 References
7-1	Chapter 7 Application of Traffic Control Devices
7-4	7.1 Introduction
7-4	7.2 Principles
7-5	7.3 Pavement Markings
7-17	7.4 Signing
7-31	7.5 Signalization
7-38	7.6 At-Grade Rail Crossings
7-42	7.7 References
8-1	Chapter 8 Illumination
8-3	8.1 Introduction
8-3	8.2 General Considerations
8-5	8.3 Lighting Levels
8-6	8.4 Equipment Type and Location
8-11	8.5 References
9-1	Chapter 9 Landscaping
9-3	9.1 Introduction
9-7	9.2 Principles
9-8	9.3 Central Island Landscaping
9-13	9.4 Splitter Island and Approach Landscaping
9-13	9.5 Maintenance
9-15	9.6 References
10-1	Chapter 10 Construction and Maintenance
10-3	10.1 Introduction
10-3	10.2 Public Education
10-4	10.3 Construction Staging
10-10	10.4 Work Zone Traffic Control
10-11	10.5 Construction Plans
10-11	10.6 Construction Coordination
10-13	10.7 Maintenance
10-16	10.8 References
1	Glossary
13	Bibliography

- A-1 **Appendix A** Example Pavement Marking Designs
for Roundabouts
- B-1 **Appendix B** User Education
- C-1 **Appendix C** Rules of the Road
- D-1 **Appendix D** Design Supplemental Materials

IMAGE CREDITS

American Structurepoint Inc.: Exhibit 1-16(b), 6-87

Brian Walsh: Exhibit 3-10, 9-6(a), 10-7

Casey Bergh: Exhibit 1-16(a)

City of Clearwater, Florida: Exhibit 2-3

City of Fort Worth, Texas: Exhibit 1-3

Clackamas County, Oregon: Exhibit 3-5

Connecticut Department of Transportation: Exhibit 6-23

Edward Myers: Exhibit 10-5

Erin Ferguson: Exhibit 3-22(b)

Hillary Isebrands: Exhibit 6-19(a)

Howard McCulloch: Exhibit 3-11, 6-91(b), 10-8

Joe Bared: Exhibit 6-83(a)

Joe Sullivan: Exhibit 1-13(a)

Kansas Department of Transportation: Exhibit 6-20, 6-90

Ken Courage: Exhibit 1-7(f)

Lee Rodegerdts: Exhibits 1-4(all), 1-5(all), 1-7(b-e), 1-8(a-d,f-h), 1-11, 2-2, 2-4(all), 3-2, 3-6, 3-7, 3-8, 3-9, 6-3, 6-6, 6-19(b), 6-22(all), 6-41, 6-65, 6-71(all), 6-88, 6-90(a), 6-91(a), 6-92(all), 7-26, 7-27(all), 7-29(all), 7-31(all), 7-33(a), 8-3(all), 9-1(all), 9-5, 9-6(b-d), 9-9(all), 10-4(all), 10-6

Livingston County, Michigan: Exhibit 6-83(b)

Mark Johnson: 6-86, 7-2

Mark Lenters: Exhibit 1-6(a), 1-7(a), 1-8(e), 9-8

Maryland State Highway Administration: Exhibit 3-3, 3-4, 6-45

Michael Moule: Exhibit 7-33(b)

Missouri Department of Transportation: Exhibit 3-22(a)

New York State Department of Transportation: Exhibit 1-6(b)

Skagit County: Exhibit 1-13(b)

Wisconsin Department of Transportation: Exhibit 1-16(c)

CHAPTER 1
INTRODUCTION**CONTENTS**

1.1 INTRODUCTION	1-3
1.2 DISTINGUISHING CHARACTERISTICS OF A ROUNDABOUT	1-3
1.2.1 Other Types of Circular Intersections	1-4
1.2.2 Comparison of Features between Roundabouts and Other Circular Intersections	1-8
1.2.3 Additional Design Features	1-8
1.3 CATEGORIES OF ROUNDABOUTS	1-10
1.3.1 Mini-Roundabouts	1-12
1.3.2 Single-Lane Roundabouts	1-13
1.3.3 Multilane Roundabouts	1-13
1.4 SCOPE OF THE GUIDE	1-17
1.5 ORGANIZATION OF THE GUIDE	1-17
1.6 REFERENCES	1-19

LIST OF EXHIBITS

Exhibit 1-1 Key Roundabout Characteristics 1-3

Exhibit 1-2 Description of Key Roundabout Features 1-4

Exhibit 1-3 Example of a Rotary 1-5

Exhibit 1-4 Example of a Signalized Traffic Circle 1-6

Exhibit 1-5 Example of Neighborhood Traffic Circles 1-7

Exhibit 1-6 Conversions of Rotaries to Roundabouts 1-8

Exhibit 1-7 Comparison of Roundabouts with Traffic Circles 1-9

Exhibit 1-8 Common Roundabout Design Features 1-10

Exhibit 1-9 Roundabout Category Comparison 1-12

Exhibit 1-10 Features of Typical Mini-Roundabout 1-12

Exhibit 1-11 Example of Mini-Roundabout 1-13

Exhibit 1-12 Features of Typical Single-Lane Roundabout 1-14

Exhibit 1-13 Examples of Single-Lane Roundabouts 1-14

Exhibit 1-14 Features of Typical Two-Lane Roundabout 1-15

Exhibit 1-15 Features of Typical Three-Lane Roundabout 1-15

Exhibit 1-16 Examples of Multilane Roundabouts 1-16

1.1 INTRODUCTION

A roundabout is a form of circular intersection in which traffic travels counterclockwise (in the United States and other right-hand traffic countries) around a central island and in which entering traffic must yield to circulating traffic. Exhibit 1-1 is a drawing of a typical roundabout, annotated to identify the key characteristics. Exhibit 1-2 provides a description of each of the key features.

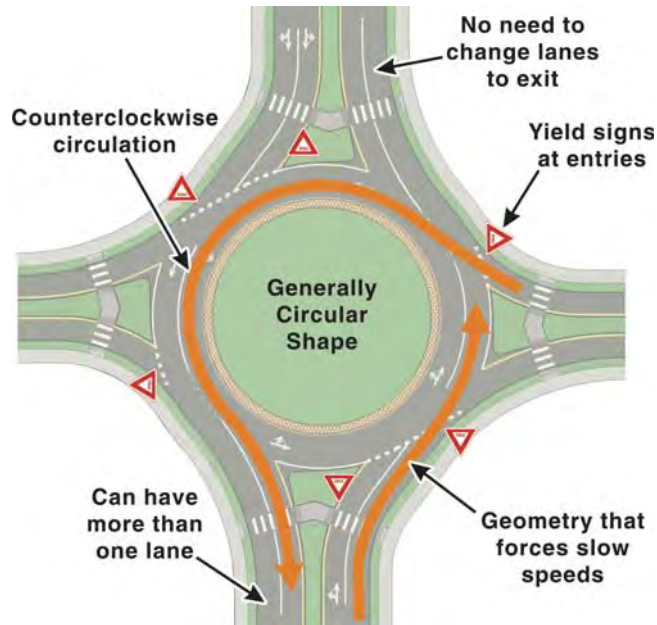

1.2 DISTINGUISHING CHARACTERISTICS OF A ROUNDABOUT

Traffic circles have been part of the transportation system in the United States since at least 1905 when one of the first circles, known as the Columbus Circle in New York City, was designed by William Phelps Eno. Subsequently, many large circles or rotaries were built in the United States. The prevailing designs enabled high-speed merging and weaving of vehicles. Priority was given to entering vehicles, facilitating high-speed entries. Yet, high crash experience and congestion in the circles led to rotaries falling out of favor in America after the mid-1950s. Internationally, the experience with traffic circles was equally negative, with many countries experiencing circles that locked up as traffic volumes increased.

The modern roundabout was developed in the United Kingdom to rectify problems associated with these traffic circles. In 1966, the United Kingdom adopted a rule at all circular intersections that required entering traffic to give

Exhibit 1-1 Key Roundabout Characteristics

Key roundabout features include a generally circular shape, yield control of entering traffic, and geometric curvature and features to induce desirable vehicular speeds.

Splitter islands have multiple roles: separate entering and exiting traffic, deflect and slow entering traffic, and provide a pedestrian refuge.

The modern roundabout was developed in the United Kingdom in the 1960s.

Roundabouts: An Informational Guide

Exhibit 1-2
Description of Key
Roundabout Features

Feature	Description
Central island	The central island is the raised area in the center of a roundabout around which traffic circulates. The central island does not necessarily need to be circular in shape. In the case of mini-roundabouts the central island is traversable.
Splitter island	A splitter island is a raised or painted area on an approach used to separate entering from exiting traffic, deflect and slow entering traffic, and allow pedestrians to cross the road in two stages.
Circulatory roadway	The circulatory roadway is the curved path used by vehicles to travel in a counterclockwise fashion around the central island.
Apron	An apron is the traversable portion of the central island adjacent to the circulatory roadway that may be needed to accommodate the wheel tracking of large vehicles. An apron is sometimes provided on the outside of the circulatory roadway.
Entrance line	The entrance line marks the point of entry into the circulatory roadway. This line is physically an extension of the circulatory roadway edge line but functions as a yield or give-way line in the absence of a separate yield line. Entering vehicles must yield to any circulating traffic coming from the left before crossing this line into the circulatory roadway.
Accessible pedestrian crossings	For roundabouts designed with pedestrian pathways, the crossing location is typically set back from the entrance line, and the splitter island is typically cut to allow pedestrians, wheelchairs, strollers, and bicycles to pass through. The pedestrian crossings must be accessible with detectable warnings and appropriate slopes in accordance with ADA requirements.
Landscape strip	Landscape strips separate vehicular and pedestrian traffic and assist with guiding pedestrians to the designated crossing locations. This feature is particularly important as a wayfinding cue for individuals who are visually impaired. Landscape strips can also significantly improve the aesthetics of the intersection.

way, or yield, to circulating traffic. This rule prevented circular intersections from locking up by not allowing vehicles to enter the intersection until there were sufficient gaps in circulating traffic. In addition, smaller circular intersections were proposed that required adequate horizontal curvature of vehicle paths to achieve slower entry and circulating speeds.

These changes improved the safety characteristics of the circular intersections by reducing the number and the severity of crashes. The modern roundabout represents a significant improvement, in terms of both operations and safety, when compared with older rotaries and traffic circles (1–3). Therefore, many countries have adopted the modern roundabout as a common intersection form, and some have developed extensive design guides and methods to evaluate the operational performance of modern roundabouts.

1.2.1 OTHER TYPES OF CIRCULAR INTERSECTIONS

Roundabouts are but one type of circular intersection. In fact, there are at least four distinct types:

1. *Roundabouts* are a subset of circular intersections with specific design and traffic control features. These features include yield control of all entering traffic, channelized approaches, and geometric curvature and features to induce desirable vehicular speeds.

Modern roundabouts provide substantially better operational and safety characteristics than older traffic circles and rotaries.

Types of circular intersections.

2. *Rotaries* (see Exhibit 1-3), an old-style circular intersection common to the United States prior to the 1960s, are characterized by a large diameter [often greater than 300 ft (100 m)]. The diameter of a rotary is primarily a consequence of the length of the weaving section required between intersection legs. Unlike the modern roundabout, lane changes are typically required within a rotary for some movements. In addition, some rotaries operate with circulating traffic yielding to entering traffic, which can create congestion on the circulatory roadway. Circulating speeds are high due to the large diameter, making maneuvers within the circle more challenging.



Fort Worth, Texas

Exhibit 1-3
Example of a Rotary

3. *Signalized traffic circles* are old-style circular intersections used in some cities in the United States where traffic signals are used to control one or more entry–circulating point. As a result, signalized traffic circles have distinctly different operational characteristics from yield-controlled roundabouts, with queue storage within the circulatory roadway and progression of signals required. Exhibit 1-4 provides an example of a signalized traffic circle. Note that signalized traffic circles are distinct from roundabouts with pedestrian signals, as the entry–circulating point at a roundabout is still governed by a yield sign.
4. *Neighborhood traffic circles* are typically built at the intersections of local streets for reasons of traffic calming and/or aesthetics. The intersection approaches may be uncontrolled or stop-controlled. They do not typically

*Roundabouts: An Informational Guide***Exhibit 1-4**
Example of a Signalized
Traffic Circle

(a) Hollywood, Florida



(b) Cape Town, Western Cape, South Africa

include raised channelization to guide the approaching driver onto the circulatory roadway. At some traffic circles, left-turning movements for larger vehicles are allowed to occur in front of the central island, potentially conflicting with other circulating traffic. Exhibit 1-5 shows examples of typical neighborhood traffic circles. The example in Portland, Oregon, is an all-way stop-controlled intersection; the example in Seattle, Washington, is uncontrolled.

There are cases in which a rotary or traffic circle has been successfully retrofitted with a modern roundabout design. While it may be difficult to incorporate all of the design features and characteristics of a modern roundabout, if the primary design principles are achieved, the retrofitted intersection may still operate efficiently and safely as a roundabout.



(a) Portland, Oregon



(b) Seattle, Washington

Exhibit 1-5
Example of Neighborhood
Traffic Circles

Exhibit 1-6 provides two examples of intersections that were converted to modern roundabouts from older rotary designs. The Long Beach, California, example retains the original diameter of the rotary but improves the design of the entries. The Kingston, New York, example has a new roundabout built inside the old rotary; the photograph was taken partway through the conversion process.

Since the purpose of this guide is to assist in the planning, design, and performance evaluation of roundabouts, not other circular intersections, it is important to be able to distinguish between them. These distinctions may not always be obvious, and rotaries or neighborhood traffic circles (hereafter referred to as “traffic circles”) may be mistaken for a roundabout by the public or even technical staff.

Circular intersections that do not conform to the characteristics of modern roundabouts are called “traffic circles” in this guide.

*Roundabouts: An Informational Guide***Exhibit 1-6**
Conversions of Rotaries
to Roundabouts

(a) Long Beach, California



(b) Kingston, New York

Therefore, the ability to carefully distinguish roundabouts from other circular intersections is important.







1.2.2 COMPARISON OF FEATURES BETWEEN ROUNDABOUTS AND OTHER CIRCULAR INTERSECTIONS

Exhibit 1-7 identifies some of the major characteristics of roundabouts and contrasts them with other circular intersections. Note that all circular intersections should have counterclockwise rotation in the United States and other countries with right-hand traffic, except in specific instances where larger trucks need to turn left in front of the central island. Some of the traffic circles shown have many of the features associated with roundabouts but are different in one or more critical areas. Note also that these characteristics apply to yield-controlled roundabouts; signalized roundabouts are a special case discussed in later chapters.

1.2.3 ADDITIONAL DESIGN FEATURES

In addition to the design characteristics identified in the previous section, roundabouts often include one or more additional design features intended to enhance the safety and/or capacity of the intersection. However, their absence does not necessarily preclude an intersection from operating as a roundabout. These additional features are identified in Exhibit 1-8.

Exhibit 1-7
Comparison of Roundabouts
with Traffic Circles

Roundabouts	Traffic Circles
Traffic Control	
Yield control is used on all entries. The circulatory roadway has no control.	Some traffic circles use stop control, or no control, on one or more entries.
	
(a) Santa Barbara, California	(b) Howard County, Maryland
Priority to Circulating Vehicles	
Circulating vehicles have the right-of-way.	Some traffic circles require circulating traffic to yield to entering traffic.
	
(c) Juneau, Alaska	(d) Paris, France
Direction of Circulation	
All vehicles circulate counterclockwise and pass to the right of the central island.	Some neighborhood traffic circles are so small that large vehicles may need to pass to the left of the central island.
	
(e) Sherwood, Oregon	(f) Portland, Oregon

Roundabouts: An Informational Guide

Exhibit 1-8
Common Roundabout
Design Features

Adequate Speed Reduction

Good roundabout design requires entering vehicles to negotiate the roundabout at slow speeds. Once within the circulatory roadway, vehicle paths are further deflected by the central island.

Some roundabouts allow high-speed entries for major movements. This increases the risk for more severe crashes for vehicles, bicycles, and pedestrians.



(a) Ladera Ranch, California



(b) Bradenton Beach, Florida

Design Vehicle

Good roundabout design makes accommodation for the appropriate design vehicle. This may require the use of an apron.

Some roundabouts may not be designed to accommodate large vehicles that periodically approach the intersection.



(c) Lothian, Maryland



(d) Naples, Florida

1.3 CATEGORIES OF ROUNDABOUTS

For the purposes of this guide, roundabouts have been separated into three basic categories according to size and number of lanes to facilitate discussion of specific performance or design issues: *mini-roundabouts*, *single-lane roundabouts*, and *multilane roundabouts*.

Note that separate categories have not been explicitly identified for rural, urban, and suburban areas. Roundabouts in urban areas may require smaller

Exhibit 1-8 (cont.)
Common Roundabout
Design Features

Entry Flare

Flare on an entry to a roundabout is the widening of an approach to multiple lanes to provide additional capacity and storage at the entrance line.



(e) Long Beach, California

Splitter Island

All but some mini-roundabouts have raised splitter islands. These are designed to separate traffic moving in opposite directions, deflect entering traffic, and to provide opportunities for pedestrians to cross in two stages. Mini-roundabouts may have splitter islands defined only by pavement markings.



(f) Lawrence, Kansas

Pedestrian Crossing Locations

Pedestrian crossings are located only across the legs of the roundabout, typically separated from the circulatory roadway by at least one vehicle length.



(g) Coralville, Iowa

Parking

No parking is allowed within the circulatory roadway or at the entries. Parking maneuvers within the intersection, as is the case at some traffic circles, interfere with circulatory flow and present a potential safety hazard.



(h) Orange, California

inscribed circle diameters due to smaller design vehicles and existing right-of-way constraints. They may also include more extensive pedestrian and bicycle features. Roundabouts in rural areas typically have higher approach speeds and thus may need special attention to visibility, approach alignment, and cross-sectional details. Suburban roundabouts may combine features of both urban and rural environments.

Exhibit 1-9 summarizes and compares some fundamental design and operational elements for each of the three roundabout categories. The following sections provide a qualitative discussion of each category.

Roundabouts: An Informational Guide

Exhibit 1-9
Roundabout Category
Comparison

Design characteristics of the three roundabout categories.

Design Element	Mini-Roundabout	Single-Lane Roundabout	Multilane Roundabout
Desirable maximum entry design speed	15 to 20 mph (25 to 30 km/h)	20 to 25 mph (30 to 40 km/h)	25 to 30 mph (40 to 50 km/h)
Maximum number of entering lanes per approach	1	1	2+
Typical inscribed circle diameter	45 to 90 ft (13 to 27 m)	90 to 180 ft (27 to 55 m)	150 to 300 ft (46 to 91 m)
Central island treatment	Fully traversable	Raised (may have traversable apron)	Raised (may have traversable apron)
Typical daily service volumes on 4-leg roundabout below which may be expected to operate without requiring a detailed capacity analysis (veh/day)*	Up to approximately 15,000	Up to approximately 25,000	Up to approximately 45,000 for two-lane roundabout

*Operational analysis needed to verify upper limit for specific applications or for roundabouts with more than two lanes or four legs.

In most cases, roundabouts in all three categories are designed with pedestrian and bicycle facilities; however, in some instances a jurisdiction may choose to not provide these features if these types of users are not anticipated or can be better served in another location.

1.3.1 MINI-ROUNDBOUTS

Mini-roundabouts are small roundabouts with a fully traversable central island. They are most commonly used in low-speed urban environments with average operating speeds of 30 mph (50 km/h) or less. Exhibit 1-10 shows the features of typical mini-roundabouts, and Exhibit 1-11 provides an example. They can be useful in such environments where conventional roundabout design

Mini-roundabouts can be useful in low-speed urban environments with right-of-way constraints.

Exhibit 1-10
Features of Typical
Mini-Roundabout

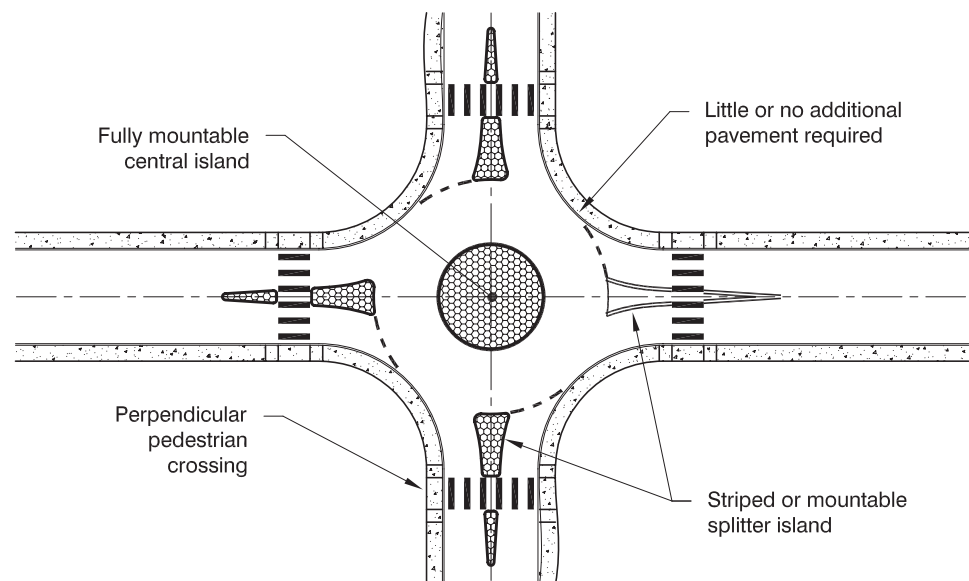



Dimondale, Michigan

Exhibit 1-11
Example of Mini-Roundabout

is precluded by right-of-way constraints. In retrofit applications, mini-roundabouts are relatively inexpensive because they typically require minimal additional pavement at the intersecting roads and minor widening at the corner curbs. They are mostly recommended when there is insufficient right-of-way to accommodate the design vehicle with a traditional single-lane roundabout. Because they are small, mini-roundabouts are perceived as pedestrian-friendly with short crossing distances and very low vehicle speeds on approaches and exits.

A fully traversable central island is provided to accommodate large vehicles and serves one of the distinguishing features of a mini-roundabout. The mini-roundabout is designed to accommodate passenger cars without requiring them to traverse over the central island. The overall design of a mini-roundabout should align vehicles at entry to guide drivers to the intended path and minimize running over of the central island to the extent possible.

1.3.2 SINGLE-LANE ROUNDABOUTS

This type of roundabout is characterized as having a single-lane entry at all legs and one circulatory lane. Exhibit 1-12 shows the features of typical single-lane roundabouts, and Exhibit 1-13 provides examples. They are distinguished from mini-roundabouts by their larger inscribed circle diameters and non-traversable central islands. Their design allows slightly higher speeds at the entry, on the circulatory roadway, and at the exit. The geometric design typically includes raised splitter islands, a non-traversable central island, crosswalks, and a truck apron. The size of the roundabout is largely influenced by the choice of design vehicle and available right-of-way.

1.3.3 MULTILANE ROUNDABOUTS

Multilane roundabouts have at least one entry with two or more lanes. In some cases, the roundabout may have a different number of lanes on one or

Roundabouts: An Informational Guide

Exhibit 1-12
Features of Typical Single-Lane Roundabout

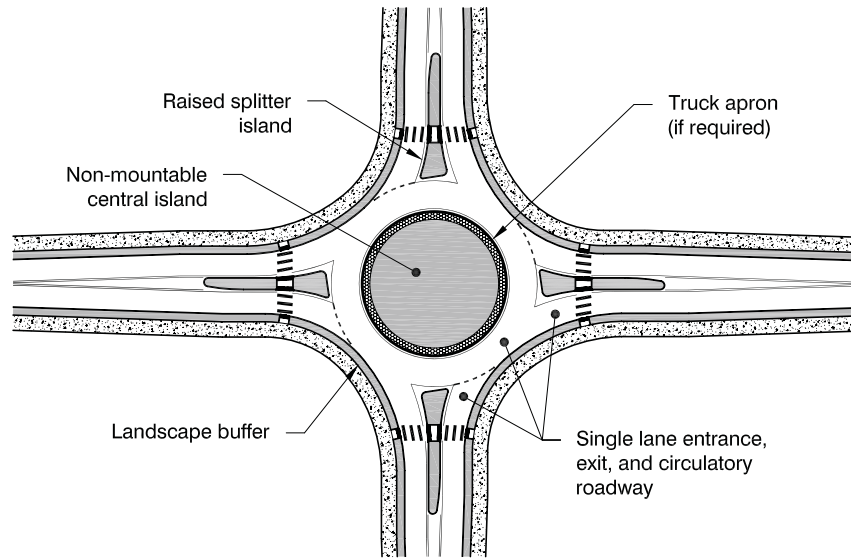

Exhibit 1-13
Examples of Single-Lane Roundabouts



(a) Dublin, Ohio



(b) Skagit County, Washington

more approaches (e.g., two-lane entries on the major street and one-lane entries on the minor street). They also include roundabouts with entries on one or more approaches that flare from one to two or more lanes. These require wider circulatory roadways to accommodate more than one vehicle traveling side by side. Exhibit 1-14 through Exhibit 1-16 provide examples of typical multilane roundabouts. The speeds at the entry, on the circulatory roadway, and at the exit are similar or may be slightly higher than those for the single-lane roundabouts. The geometric design will include raised splitter islands, truck apron, a non-traversable central island, and appropriate entry path deflection.

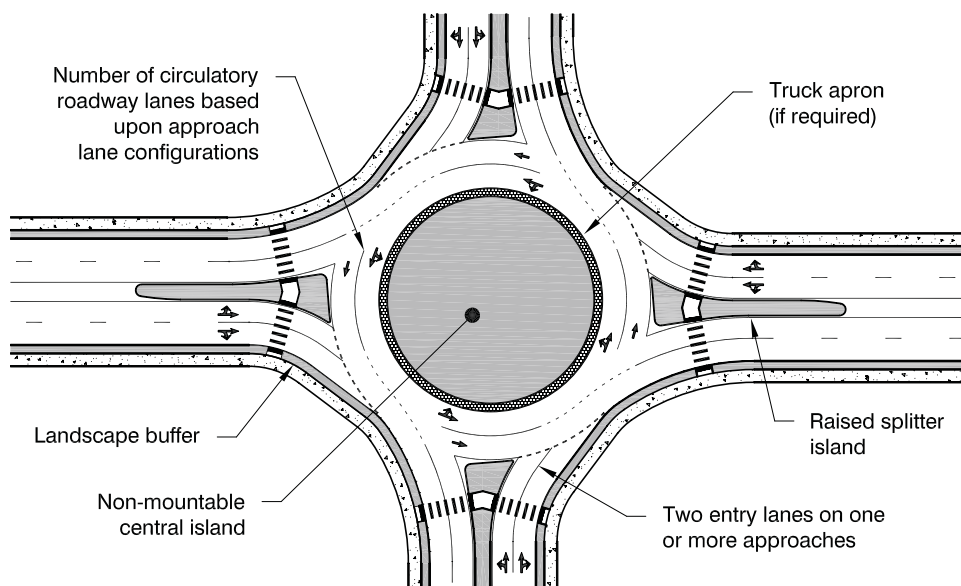

Exhibit 1-14
Features of Typical Two-Lane Roundabout

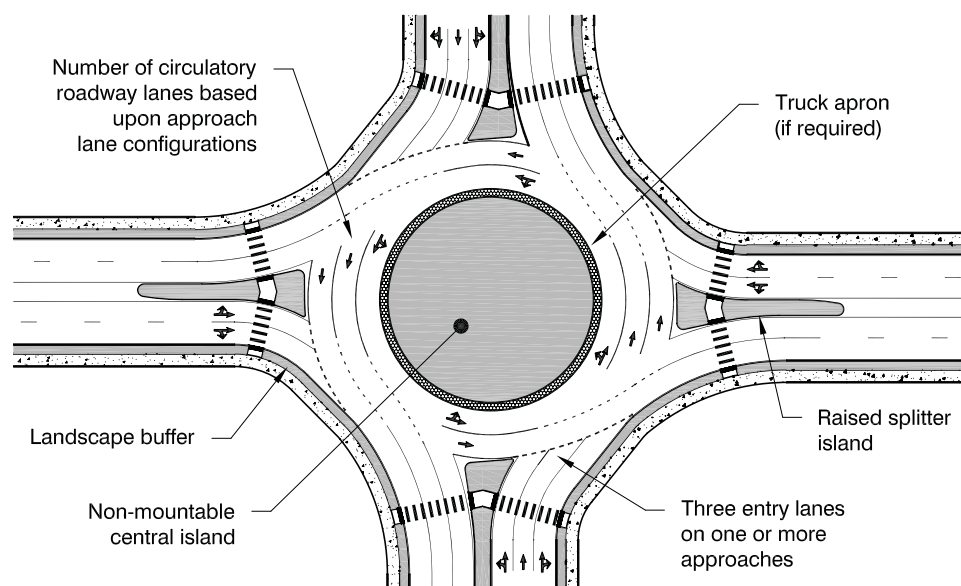

Exhibit 1-15
Features of Typical Three-Lane Roundabout

Roundabouts: An Informational Guide

Exhibit 1-16
Examples of Multilane
Roundabouts



(a) Bend, Oregon



(b) Carmel, Indiana



(c) Wisconsin Rapids, Wisconsin

1.4 SCOPE OF THE GUIDE

This guide provides information and guidance on roundabouts, resulting in designs that are suitable for a variety of typical conditions in the United States. The scope of this guide is to provide general information, planning techniques, evaluation procedures for assessing operational and safety performance, design guidelines for roundabouts, and principles to be considered for selecting and designing roundabouts. The most important principles will be highlighted in the margins throughout this document.

This guide has been developed with the input of transportation practitioners and researchers from around the world. In many cases, items from national and international practice and research indicate considerable consensus, and these items have been included in this guide. However, other items have generated considerable differences of opinion (e.g., methods of estimating capacity), and some practices vary considerably from country to country (e.g., marking of the circulatory roadway in multilane roundabouts). Where international consensus is not apparent, a reasoned approach is presented that the authors believe is currently most appropriate for the United States. As more roundabouts are built, the opportunity to conduct research to refine or develop better methods will enable future editions of this guide to improve.

Despite the comprehensive nature of this document, it cannot discuss every issue related to roundabouts. In particular, it does not cover the following topics:

- *Non-traversable traffic calming circles.* These are small traffic circles with raised central islands. They are typically used on local streets for speed and volume control. They are typically not designed to accommodate large vehicles, and often left-turning traffic is required to turn left in front of the circle. Mini-roundabouts, which are covered, may be an appropriate substitute. Additionally, there may be some advantage to using roundabout principles (e.g., yield on entry, mountable or painted splitter islands, etc.) at these traffic calming circles.
- *Specific legal or policy requirements and language.* The legal information that is provided in this guide is intended only to make the reader aware of potential issues. The reader is encouraged to consult with an attorney before adopting any of the recommendations contained herein on specific legal issues of concern. Similarly, regarding policy information, the guide refers to or encompasses applicable policies, such as those of the American Association of State Highway and Transportation Officials (AASHTO) (4). It does not, however, establish any new policies.

Topics not discussed in this guide.

1.5 ORGANIZATION OF THE GUIDE

This guide has been structured to address the needs of a variety of readers, including the general public, policy makers, transportation planners, operations and safety analysts, and conceptual and detailed designers. This chapter distinguishes

roundabouts from other circular intersections and defines the types of roundabouts addressed in the remainder of the guide. The remaining chapters in this guide increase in the level of detail provided.

Chapter 2—Roundabout Considerations: This chapter provides a broad overview of the performance characteristics of roundabouts and discusses the various trade-offs of installing roundabouts versus other types of intersections. Legal issues and public involvement techniques are also discussed.

Chapter 3—Planning: This chapter provides guidelines for identifying appropriate intersection control options given daily traffic volumes and identifies procedures for evaluating the feasibility of a roundabout at a given location. This chapter provides sufficient detail for a transportation engineer or planner to decide under what circumstances roundabouts are likely to be appropriate and how they compare to alternatives at a specific location. Public involvement tools and techniques are also discussed in this chapter.

Chapter 4—Operational Analysis: This chapter identifies methods for analyzing the operational performance of each category of roundabout in terms of capacity, delay, and queuing.

Chapter 5—Safety: This chapter discusses the expected safety performance of roundabouts and methods for analyzing safety performance.

Chapter 6—Geometric Design: This chapter presents geometric design principles, design elements for each category of roundabout, and design applications.

Chapter 7—Application of Traffic Control Devices: This chapter discusses a number of traffic design aspects, including pavement markings, signs, and traffic signals.

Chapter 8—Illumination: This chapter discusses principles and recommendations regarding illumination, along with recommended lighting levels and potential equipment types.

Chapter 9—Landscaping: This chapter presents recommendations for landscaping at roundabouts. Discussions include the relationship to visibility and sight distance requirements, types of landscaping and fixed objects appropriate for the central island and external areas, and other relevant items. A brief discussion of the use of art and other aesthetics in the vicinity of roundabouts is also provided.

Chapter 10—Construction and Maintenance: This chapter focuses on constructability and maintenance of a roundabout.

Appendices: Appendices are provided to expand upon topics in certain chapters.

Several typographical devices have been used to enhance the readability of the guide. Margin notes, such as the note next to this paragraph, highlight important points or identify cross-references to other chapters of the guide. References have been listed at the end of each chapter and have been indicated in the text using italic numbers in parentheses, such as: (3). New terms are presented in italics and are defined in the glossary at the end of the document.

Margin notes have been used to highlight important points.

1.6 REFERENCES

1. Brown, M. *TRL State of the Art Review: The Design of Roundabouts*. HMSO, London, 1995.
2. Todd, K. "A History of Roundabouts in Britain." *Transportation Quarterly*, Vol. 45, No. 1, January 1991.
3. Jacquemart, G. *Synthesis of Highway Practice 264: Modern Roundabout Practice in the United States*. TRB, National Research Council, Washington, D.C., 1998.
4. A Policy on Geometric Design of Highways and Streets. AASHTO, Washington, D.C., 2006.

CHAPTER 2

ROUNDBOUT CONSIDERATIONS

CONTENTS

2.1 INTRODUCTION	2-3
2.2 GENERAL CHARACTERISTICS	2-3
2.2.1 Safety	2-3
2.2.2 User Decisions	2-4
2.2.3 Traffic Operations	2-5
2.2.4 Spatial Requirements	2-7
2.2.5 Access Management	2-9
2.2.6 Environmental Factors	2-9
2.2.7 Operation and Maintenance Costs	2-9
2.2.8 Traffic Calming	2-10
2.2.9 Aesthetics	2-10
2.2.10 Summary of Advantages and Disadvantages	2-11
2.3 USER CONSIDERATIONS	2-13
2.3.1 Pedestrians	2-13
2.3.2 Pedestrians with Disabilities	2-15
2.3.3 Bicyclists	2-17
2.3.4 Older Drivers	2-18
2.3.5 Large Vehicles	2-19
2.3.6 Transit	2-20
2.3.7 Emergency Vehicles	2-20
2.3.8 Rail Crossings	2-20
2.4 POLICY AND LEGAL ISSUES	2-21
2.4.1 Decision-Making Process	2-21
2.4.2 Rules of the Road	2-21
2.5 REFERENCES	2-22

LIST OF EXHIBITS

Exhibit 2-1 Wide Nodes, Narrow Roads Concept 2-8

Exhibit 2-2 Example of Wide Nodes, Narrow Roads Concept 2-8

Exhibit 2-3 Example of Gateway Treatment 2-11

Exhibit 2-4 Examples of Aesthetic Treatments 2-11

Exhibit 2-5 Summary of Roundabout Advantages and Disadvantages 2-12

2.1 INTRODUCTION

This chapter provides a general overview of the characteristics of roundabouts and considerations for all users. A discussion of legal considerations and user education provides policy makers with the information they need to make appropriate decisions and convey direction to the public. Understanding the advantages and disadvantages of roundabouts allows designers, policy makers, and the public to understand the trade-offs with this type of intersection treatment.

While general information about roundabouts can be found in this chapter, the reader is encouraged to refer to later, more detailed chapters on the specifics associated with planning, operation, safety, and design of roundabouts.

2.2 GENERAL CHARACTERISTICS

Many jurisdictions are looking for alternative intersection control methods to improve safety and carry more traffic without widening roadways. Roundabouts are becoming more popular based on the multiple advantages to safety, operations, and aesthetics. However, as agencies become increasingly familiar with these types of intersections, it is important to understand both advantages and disadvantages.

2.2.1 SAFETY

Roundabouts have been demonstrated to be safer than other forms of at-grade intersections (1). The safety benefit is particularly notable for fatal and injury crashes. This section provides an overview of key safety issues; the reader is encouraged to refer to Chapter 5 for a more detailed discussion.

The safety performance of a roundabout is a product of its design. At roundabouts, vehicles travel in the same direction, eliminating the right-angle and left-turn conflicts associated with traditional intersections. In addition, good roundabout design places a high priority on speed control. Speed control is provided by geometric features, not just by traffic control devices or by the impedance of other traffic. Because of this, speed control can be achieved at all times of day. If achieved by good design, in principle, lower vehicle speeds should provide the following safety benefits:

- Provide more time for entering drivers to judge, adjust speed for, and enter a gap in circulating traffic, allowing for safer merges;
- Reduce the size of sight triangles needed for users to see one another;
- Increase the likelihood of drivers yielding to pedestrians (compared to an uncontrolled crossing);
- Provide more time for all users to detect and correct for their mistakes or mistakes of others;
- Make crashes less frequent and less severe, including crashes involving pedestrians and bicyclists; and
- Make the intersection safer for novice users.

Roundabouts have been demonstrated to be safer for motor vehicles and pedestrians than other forms of at-grade intersections.

Good roundabout designs encourage speed control.

Roundabouts: An Informational Guide

Single-lane roundabouts designed for low-speed operation are one of the safest treatments available for at-grade intersections.

Single-lane roundabouts designed for low-speed operation are one of the safest treatments available for at-grade intersections. Drivers have no lane use decisions to make. Pedestrians cross one lane of traffic at a time. Roadway speeds and widths are low enough to allow comfortable mixed bicycle and motor vehicle flow.

Due to the increased number of conflicting and interacting movements, multi-lane roundabouts often cannot achieve the same levels of safety improvement as their single-lane counterparts. Driver decisions are more complex at multilane roundabouts, with the most important being proper lane selection before entering the intersection. Pedestrians face potential multiple-threat conflicts as they cross more than one lane of traffic at a time. Visually impaired pedestrians face a significantly more complex auditory environment that may reduce the accessibility of the intersection without additional treatments. Cyclists traveling as vehicles must select the correct lane for circulating; if traveling as pedestrians, they face the same conflicts as other pedestrians. Despite these challenges, the overall safety performance of multilane roundabouts is often better than comparable signalized intersections, particularly in terms of fatal and injury crashes.

2.2.2 USER DECISIONS

User decisions—that is, decisions by drivers, pedestrians, and cyclists—are generally simpler at roundabouts than at other intersection treatments. However, roundabouts also place more reliance on individuals to make decisions rather than directing them by a traffic control device.

2.2.2.1 Drivers

Drivers approaching a single-lane roundabout have two basic decisions regarding other users: select the appropriate lane (as applicable) for their intended destination, and yield to those who have the right-of-way. Making navigating decisions in roundabouts is generally more complex than for other intersection types, mainly because the driver cannot always see the exit or destination and the fact that the intersection is curved requiring drivers to gradually change direction, potentially disorienting a driver as to their origin and destination. As a consequence the designer may need to provide additional guidance in the form of signs and markings to aid in driver navigation.

The latter of the two decisions—yielding to those who have the right-of-way—occurs at several points when negotiating the roundabout:

- Drivers must be mindful of any bicyclists merging into motor vehicle traffic from the right side of the road, a bicycle lane, or shoulder.
- Drivers must yield to any pedestrians crossing at the entry (the laws on this vary somewhat from state to state).
- Drivers must choose an acceptable gap in which to enter the roundabout.
- Drivers must yield to any pedestrians crossing the exit (the laws on this vary somewhat from state to state).

By contrast, a driver making a left turn from the minor leg of a two-way stop-controlled intersection yields to pedestrians and bicyclists and judges gaps in the

major street through movements from both directions, as well as the major street left and right turns and opposing minor through and right turns.

Signalized intersections attempt to simplify the decision-making process for drivers, especially at locations where protected left-turn phasing is provided, by separating conflicts in time and space. However, the rules and driver decisions for negotiating signalized intersections are still quite complex in many cases. For signals with permissive left-turn phasing, the driver must be cognizant of the opposing vehicular traffic and its speed, presence of pedestrians, and the signal indication itself (to ensure a legal maneuver). In addition, at traffic signals, failure on the part of a driver can be associated with occasionally severe consequences for those involved.

By contrast, once at the yield line, the entering driver at a roundabout can focus attention entirely on the circulating traffic stream approaching from the left. A driver behind the entering driver can focus entirely on crossing pedestrians. While operation in a roundabout requires increased user vigilance, as compared to traffic signals, the consequence of an error at a roundabout is less severe by comparison.

2.2.2.2 Pedestrians

The design of a roundabout allows pedestrians to cross one direction of traffic at a time on each leg of the roundabout. This is significantly simpler than two-way stop-controlled intersections, where pedestrians cross parallel with the major street and contend with potential conflicts in front of and behind them (e.g., major-street left and right turns). Although signalized intersections can provide indication of when pedestrians have the right-of-way (through a WALK indication), potential conflicts can come from multiple directions: left turns on green, right turns on green, right turns on red, and red-light-running through vehicles.

2.2.2.3 Bicyclists

Bicyclist decisions at roundabouts depend on how the bicyclist chooses to travel through the intersection. If traveling as a vehicle, as is often the case for experienced cyclists and cyclists in lower volume and speed environments, the decision process mirrors that of motorized vehicles. If traveling as a pedestrian, as is often the case for less experienced cyclists and cyclists in higher volume environments, the decision process mirrors that of pedestrians.

2.2.3 TRAFFIC OPERATIONS

The operation of vehicular traffic at a roundabout is determined by gap acceptance: entering vehicles look for and accept gaps in circulating traffic. The low speeds of a roundabout facilitate this gap acceptance process. Furthermore, the operational efficiency (capacity) of roundabouts is greater at lower circulating speed because of the following two phenomena:

1. The faster the circulating traffic, the larger the gaps that entering traffic will comfortably accept. This translates to fewer acceptable gaps and therefore more instances of entering vehicles stopping at the yield line.
2. Entering traffic, which is first stopped at the yield line, requires even larger gaps in the circulating traffic in order to accelerate and merge with

the circulating traffic. The faster the circulating traffic, the larger this gap must be. This translates into fewer acceptable gaps and therefore longer delays for entering traffic.

2.2.3.1 Vehicle Delay and Queue Storage

When operating within their capacity, roundabouts typically operate with lower vehicle delays than other intersection forms and control types. With a roundabout, it is unnecessary for traffic to come to a complete stop when no conflicts are present. When there are queues on one or more approaches, traffic within the queues usually continues to move, and this is typically more tolerable to drivers than a stopped or standing queue. The performance of roundabouts during off-peak periods is particularly good compared with other intersection forms, usually with very low average delays.

2.2.3.2 Delay of Major Movements

Roundabouts tend to treat all movements at an intersection equally, with no priority provided to major movements over minor movements. Each approach is required to yield to circulating traffic, regardless of whether the approach is a local street or major arterial. This may result in more delay to the major movements than might otherwise be desired. This problem is most acute at the intersection of high-volume major streets with low- to medium-volume minor streets (e.g., major arterial streets with minor collectors or local streets). Therefore, the overall street classification system and hierarchy should be considered before selecting a roundabout (or stop-controlled) intersection. This limitation should be specifically considered on emergency response routes in comparison with other intersection types and control. The delays depend on the volume of turning movements and should be analyzed individually for each approach, according to the procedures in Chapter 4.

2.2.3.3 Signal Progression

It is common practice to coordinate traffic signals on arterial roads to minimize stops and travel time delay for through traffic on the major road. A roundabout with only yield control cannot be actively managed to provide priority to major street movements in the same way. As a result, the coordinated platoons of traffic that improve the efficiency of traffic signals can be disrupted by roundabouts, thus reducing the efficiency of downstream intersections. Roundabouts cannot be managed using a centralized traffic management system to facilitate special events, diverted traffic flows, and so on unless signals at the roundabout or in the vicinity are used for such a purpose.

On the other hand, roundabouts may present an opportunity to make more efficient use of the existing traffic signals in the vicinity. An example is the use of a roundabout at the highest-volume junction in the system, either a single large at-grade intersection or at the ramp terminals of an interchange. In many cases, the minimum cycle length needed for an entire system is governed by the highest-volume junction in the system. To minimize overall system delay, it may be beneficial to divide the signal system into subsystems separated by the roundabout, assigning each subsystem a cycle length that

Since all intersection movements at a roundabout have equal priority, major street movements may be delayed more than desired.

may be lower than before. In these cases the overall total delay, stops, and queues may be reduced.

2.2.4 SPATIAL REQUIREMENTS

Roundabouts often require more space in the immediate vicinity of the intersection than comparable stop-controlled or signalized intersections. This space requirement is dictated by a number of factors, including the size and shape of the roundabout (e.g., circular versus noncircular). However, as discussed previously in the context of a corridor, the additional space needed in the vicinity of a roundabout may be offset by reduced space needed between intersections.

To the extent that a comparable roundabout would outperform a signal in terms of reduced delay and thus shorter queues, it will require less queue storage space on the approach legs. If a signalized intersection requires long or multiple turn lanes to provide sufficient capacity or storage, a roundabout with similar capacity may require less space on the approaches. As a result, roundabouts may reduce the need for additional right-of-way on the links between intersections, at the expense of additional right-of-way requirements at the intersections themselves. It may also be possible to space roundabouts closer together than traffic signals because of shorter queue lengths.

Roundabouts present opportunities to shape the cross section of a corridor in ways that are perhaps different from those afforded by signalized intersections. Signalized intersections operate most efficiently when they progress platoons of traffic, allowing the maximum number of vehicles to pass through on green without stopping. These platoons maximize the use of green time by promoting shorter headways. However, lane continuity between signals is needed to sustain these platoons through a series of signals, and the links tend to be underused between platoons. Roundabouts, on the other hand, produce efficiency through a gap acceptance process. While the capacity for through traffic is limited by conflicting circulatory flow, drivers can accept gaps as they appear rather than waiting for their time in the cycle. The resulting flow between roundabouts tends to be more random and makes more efficient use of the links between intersections. As a result, roundabouts can be made as large as needed for node capacity, keeping the links between nodes more narrow.

This concept is sometimes referred to as a “wide nodes, narrow roads” concept and is illustrated in Exhibit 2-1. The right-of-way savings between intersections may make it feasible to accommodate parking, wider sidewalks, planter strips, and/or bicycle lanes. Another space-saving strategy is the use of flared approach lanes to provide additional capacity at the intersection while maintaining the benefit of reduced spatial requirements upstream and downstream of an intersection.

The wide nodes, narrow roads concept has a beneficial application at freeway interchanges. At interchange ramp terminals, paired roundabouts have been used to reduce the number of lanes in freeway overpasses and underpasses. In compact urban areas, there are typically signalized intersections at both ends of overpass bridges, necessitating additional overpass lanes to provide capacity and storage for left-turning vehicles. Exhibit 2-2 illustrates an example of this application in Vail, Colorado.

Roundabouts: An Informational Guide

Exhibit 2-1
Wide Nodes, Narrow Roads
Concept

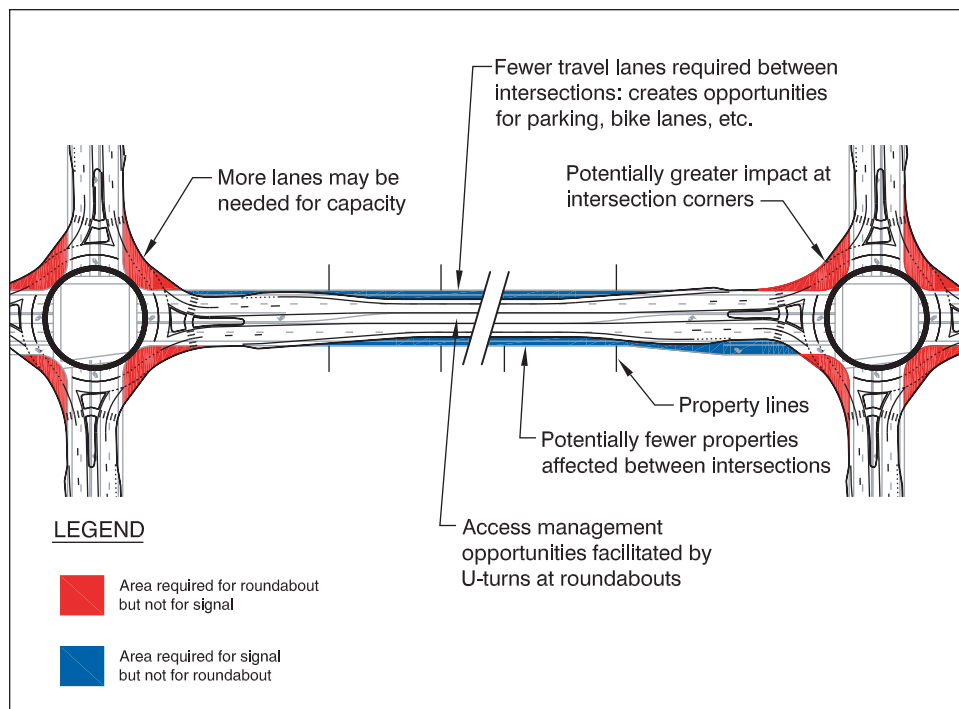

Most roundabouts on arterial streets are designed to accommodate traffic volume estimated for a future horizon year, which can extend 20 years or more from the construction date. Collector and local-street roundabouts are typically designed for full build-out conditions. While it is important to plan for future traffic volume and capacity needs, the immediate effects on pedestrian and bicycle users should also be considered. A roundabout constructed with a wide

Exhibit 2-2
Example of Wide Nodes,
Narrow Roads Concept



Vail, Colorado

cross section can negatively impact bicycle and pedestrian movements. Therefore, a phased implementation may be an appropriate way to accommodate current users' needs while still providing an opportunity for the roundabout to be expanded for future traffic volume growth. In these cases, it is important to reserve right-of-way for future planned improvements and also plan the construction material to potentially allow for easier expansion in the future. More information on phased implementation can be found in Chapter 6.

2.2.5 ACCESS MANAGEMENT

Roundabouts can be used at key public and private intersections to facilitate major movements and enhance access management. Minor public and private access points between roundabouts can be accommodated by partially or fully restricted two-way stop-controlled intersections, with the roundabouts providing U-turn opportunities. Most of the principles used for access management at conventional intersections can also be applied at roundabouts.

While roundabouts may allow for fewer lanes between intersections, the traffic pattern that emerges from roundabouts can have a significant impact on existing midblock access. The more random departure pattern that emerges from a roundabout and the potentially narrower cross section between roundabouts may reduce the number of available gaps for mid-block unsignalized intersections and driveways. As a result, an unsignalized intersection may have less capacity and more delay downstream of a roundabout than downstream of a signal, even accounting for the U-turns that roundabouts facilitate. This should be reviewed on a case-by-case basis with the given turning movement patterns of a corridor.

More discussion of access management issues and techniques can be found in Chapter 6.

2.2.6 ENVIRONMENTAL FACTORS

Roundabouts can provide environmental benefits if they reduce vehicle delay and the number and duration of stops compared with an alternative. Even when there are heavy volumes, vehicles continue to advance slowly in moving queues rather than coming to a complete stop. This may reduce noise and air quality impacts and fuel consumption significantly by reducing the number of acceleration/deceleration cycles and the time spent idling. Roundabouts may also be an alternative to help satisfy purpose and need requirements for environmental documents prepared under the National Environmental Policy Act (NEPA).

2.2.7 OPERATION AND MAINTENANCE COSTS

The initial design and construction cost of a roundabout can vary significantly depending on the roundabout size, right-of-way impacts, illumination requirements, and other design or aesthetic features that may be desired. A new single-lane roundabout intersection in an unbuilt environment can have construction costs comparable to a traffic signal. However, as the size of the roundabout increases, particularly in a fully built-out commercial or residential area, the cost of roundabout construction can be higher than that of a traffic signal, depending on the footprint of the roundabout relative to that needed for the signal. However,

the ongoing operations and maintenance cost of a roundabout can be less than that for a signal, with the possible exception of increased illumination needs for a roundabout. Although the initial construction cost may be more, a roundabout can have less operating and maintenance costs than a traffic signal, and the service life of a roundabout is significantly longer, approximately 25 years, compared with 10 years for a typical signal (2). Roundabouts also provide substantial cost savings to society due to the reduction in crashes, particularly fatal and injury crashes, over their service life.

Compared to signalized intersections, a roundabout does not have signal equipment that requires constant power, periodic light bulb and detection maintenance, and regular signal-timing updates. Roundabouts, however, can have higher landscape maintenance costs depending on the degree of landscaping provided on the central island, splitter islands, and perimeter. Illumination costs for roundabouts can be greater than for signalized intersections due to a larger area required for coverage. Drivers sometimes face a confusing situation when they approach a signalized intersection during a power failure, but such failures have minimal temporary effect on roundabouts or any other unsignalized intersections, other than the possible loss of illumination.

2.2.8 TRAFFIC CALMING

Roundabouts can have traffic calming effects on streets by reducing vehicle speeds using geometric design rather than traffic control devices or traffic volume. Consequently, speed reduction can be realized at all times of day and on streets of any traffic volume. It is difficult for drivers to speed through an appropriately designed roundabout with raised channelization that forces vehicles to physically change direction. Example applications include using roundabouts at the transition from a rural, high-speed environment to a low-speed urban environment and to demarcate commercial uses from residential areas.

Roundabouts have also been used successfully as gateway treatments at the interface between rural and urban areas where speed limits change or at freeway ramp terminals. In these applications, the traffic calming effect of roundabouts reduces traffic speeds and reinforces the notion of a significant change in the driving environment. These gateways also reduce unwanted vehicular intrusion into neighborhoods by providing a convenient U-turn location.

Exhibit 2-3 shows a photo of a roundabout in Clearwater, Florida, that provides this gateway feature between commercial and residential land uses.

2.2.9 AESTHETICS

Roundabouts offer the opportunity to provide attractive entries or centerpieces to communities. Landscaping is a desirable aesthetic feature and can be installed on the central island and splitter islands as long as sight-distance requirements are met. It may be possible to place monuments and art in some portions of the central island if they do not pose a significant safety hazard to errant vehicles. In addition, pavement textures and colors added to truck aprons or other elements improve the visual appearance of the intersection. When installing landscaping or other artistic features in the central island, clear distance and offsets should be considered to ensure that

By reducing speeds, roundabouts complement other traffic calming measures.

Landscaping issues are discussed in detail in Chapter 9.



Clearwater, Florida

hard objects directly facing the entries do not create a safety hazard. Additional guidance for landscaping and art at roundabouts is presented in Chapter 9.

Roundabouts are also used in tourist or shopping areas to aesthetically enhance the visual environment. They have been justified as a spur to economic development, conveying to developers that the area is favorable for investment in re-development. Some are exhibited as a signature feature on community postcards, advertisements, and travelogues.

Exhibit 2-4 presents examples of the aesthetic treatments that have been applied to roundabouts. Additional examples and discussion are provided in Chapter 9.

2.2.10 SUMMARY OF ADVANTAGES AND DISADVANTAGES

As described in the previous sections, roundabouts have unique features and characteristics, including safety, signal progression, environmental factors, spatial requirements, operation and maintenance costs, traffic calming, aesthetics, and



(a) Ladera Ranch, California

Exhibit 2-3
Example of Gateway
Treatment

Exhibit 2-4
Examples of Aesthetic
Treatments

Roundabouts: An Informational Guide

Exhibit 2-4 (cont.)
Examples of Aesthetic
Treatments



(b) Ottawa, Ontario, Canada

access management. The trade-offs involved when implementing a roundabout should be considered at a policy level when introducing roundabouts into a region or on a project-by-project basis at specific locations where a roundabout is one of the alternatives being considered.

Exhibit 2-5 provides an overview of the primary advantages and disadvantages of roundabouts for users, policy makers, designers, and planners to understand when considering this type of intersection.

Exhibit 2-5
Summary of Roundabout
Advantages and
Disadvantages

Advantages	Disadvantages
Non-Motorized Users	
<ul style="list-style-type: none"> • Pedestrians must consider only one direction of conflicting traffic at a time. • Bicyclists have options for negotiating roundabouts, depending on their skill and comfort level. 	<ul style="list-style-type: none"> • Pedestrians with vision impairments may have trouble finding crosswalks and determining when/if vehicles have yielded at crosswalks. • Bicycle ramps at roundabouts have the potential to be confused with pedestrian ramps.
Safety	
<ul style="list-style-type: none"> • Reduce crash severity for all users, allow safer merges into circulating traffic, and provide more time for all users to detect and correct for their mistakes or the mistakes of others due to lower vehicle speeds. • Fewer overall conflict points and no left-turn conflicts. 	<ul style="list-style-type: none"> • Increase in single-vehicle and fixed-object crashes compared to other intersection treatments. • Multilane roundabouts present more difficulties for individuals with blindness or low vision due to challenges in detecting gaps and determining that vehicles have yielded at crosswalks.
Operations	
<ul style="list-style-type: none"> • May have lower delays and queues than other forms of intersection control. • Can reduce lane requirements between intersections, including bridges between interchange ramp terminals. • Creates possibility for adjacent signals to operate with more efficient cycle lengths where the roundabout replaces a signal that is setting the controlling cycle length. 	<ul style="list-style-type: none"> • Equal priority for all approaches can reduce the progression for high volume approaches. • Cannot provide explicit priority to specific users (e.g., trains, emergency vehicles, transit, pedestrians) unless supplemental traffic control devices are provided.

Access Management	
<ul style="list-style-type: none"> Facilitate U-turns that can substitute for more difficult midblock left turns. 	<ul style="list-style-type: none"> May reduce the number of available gaps for mid-block unsignalized intersections and driveways
Environmental Factors	
<ul style="list-style-type: none"> Noise, air quality impacts, and fuel consumption may be reduced. Little stopping during off-peak periods. 	<ul style="list-style-type: none"> Possible impacts to natural and cultural resources due to greater spatial requirements at intersections.
Traffic Calming	
<ul style="list-style-type: none"> Reduced vehicular speeds. Beneficial in transition areas by reinforcing the notion of a significant change in the driving environment. 	<ul style="list-style-type: none"> More expensive than other traffic calming treatments.
Space	
<ul style="list-style-type: none"> Often require less queue storage space on intersection approaches—can allow for closer intersection and access spacing. Reduce the need for additional right-of-way between links of intersection. More feasibility to accommodate parking, wider sidewalks, planter strips, wider outside lanes, and/or bicycle lanes on the approaches. 	<ul style="list-style-type: none"> Often requires more space at the intersection itself than other intersection treatments.
Operation & Maintenance	
<ul style="list-style-type: none"> No signal hardware or equipment maintenance. 	<ul style="list-style-type: none"> May require landscape maintenance.
Aesthetics	
<ul style="list-style-type: none"> Provide attractive entries or centerpieces to communities. Used in tourist or shopping areas to separate commercial uses from residential areas. Provide opportunity for landscaping and/or gateway feature to enhance the community. 	<ul style="list-style-type: none"> May create a safety hazard if hard objects are placed in the central island directly facing the entries.

Exhibit 2-5 (cont.)
Summary of Roundabout Advantages and Disadvantages

2.3 USER CONSIDERATIONS

As with any intersection design, each transportation mode present requires careful consideration. This section offers some of the issues associated with each mode; additional detail on mode-specific safety and design issues is provided in subsequent chapters. Guidance on educating various users is provided in Chapter 3 and Appendix B.

2.3.1 PEDESTRIANS

At roundabout locations where pedestrian access is provided, pedestrians are accommodated at crosswalks around the perimeter of the roundabout. By providing space to pause on the splitter island, pedestrians can consider one direction of conflicting traffic at a time, which simplifies the task of crossing the street. The roundabout should be designed to discourage pedestrians from crossing to the central island, e.g., with landscape buffers on the corners. Crosswalks are set back from the yield line by one or more vehicle lengths to:

- Shorten the crossing distance compared to locations adjacent to the inscribed circle,

- Separate vehicle–vehicle and vehicle–pedestrian conflict points, and
- Allow the second entering driver to devote attention to crossing pedestrians while waiting for the driver ahead to enter the circulatory roadway.

As discussed in Chapter 5, relatively slow vehicle speeds and a reduced number of conflicts are two primary reasons that roundabouts are safer than most other intersection types. The slow speeds combined with well-defined crossings and splitter islands result in relatively high rates of motorists yielding to pedestrians at most roundabouts, making it easy for pedestrians to cross. Research has found that pedestrians often have very short waiting times to cross at roundabout crosswalks (3).

Most intersections are two-way stop controlled. Compared to two-way stop-controlled intersections, roundabouts typically make it easier and safer for pedestrians to cross the major street. At both roundabouts and two-way stop-controlled intersections, pedestrians have to judge gaps in the major (uncontrolled) stream of traffic. At roundabouts, sighted pedestrians only have to look in one direction at a time, within a relatively small sight angle. At traditional intersections, unless a raised median provides a refuge, pedestrians need to look in both directions on the major street. They must also be aware of vehicles turning off of the minor street, so their field of vision must be wide. Pedestrians with vision impairments can have difficulty assessing gaps at roundabouts and two-way stop-controlled intersections. By reducing stopping distance, the low vehicular speeds through a roundabout generally reduce the frequency of crashes involving pedestrians and increase the likelihood of vehicles yielding to pedestrians. The reduced kinetic energy reduces the severity of pedestrian crashes as well, if they occur.

The comparison between roundabouts and all-way stop-controlled intersections is less clear. All-way stop control is virtually nonexistent in most countries outside North America that have roundabouts, so there is little international experience with which to compare. All-way stop-controlled intersections may be preferred by pedestrians, especially those with vision impairments, because vehicles are required to stop before they enter the intersection. However, crossing an all-way stop-controlled intersection can also be intimidating, since traffic may be turning onto the exiting approach from multiple directions. Roundabouts, on the other hand, allow pedestrians to cross one direction of traffic at a time. However, traffic may be moving (albeit at a slow speed), thus making it challenging to judge gaps, especially for pedestrians who are blind or have low vision.

All-way stop-controlled intersections normally have low incidence of severe pedestrian crashes due to the fact that motorists generally stop or at least slow down significantly before going through the stop signs. However, all-way stop-controlled intersections do not provide positive geometric features to slow vehicles and instead rely entirely on the authority of the traffic control device. The roundabout geometry physically slows and deflects vehicles, reducing the likelihood of a high-speed crash due to a traffic control device violation.

When properly designed to accommodate pedestrians, signalized intersections offer positive guidance to pedestrians by providing visual and audible pedestrian signal indications. In this respect, the decision process for pedestrians requires less judgment at signalized intersections than at roundabouts, particularly for visually

impaired and elderly pedestrians. However, pedestrians at signalized intersections are vulnerable to unprotected right-turn and left-turn movements. In suburban environments with large intersections and large corner radii, these crashes occur at relatively high speeds, sometimes resulting in severe crashes. In addition, high-speed vehicle–pedestrian crashes occur when vehicles run through a red signal indication. In this respect, the roundabout provides a speed-constrained environment for through traffic.

At two-way and all-way stop intersections, right-turning motorists often look only to the left in order to check for vehicular conflicts, endangering or inconveniencing pedestrians crossing from the right or on the right. The same situation occurs with motorists at signalized intersections making right turns on red. These crashes can be severe due to the fact that many of these drivers do not come to a complete stop if they do not perceive any vehicular conflicts. With crosswalks located back from the circulatory roadway, roundabouts place pedestrians in a more visible location.

The two populations at opposite ends of the age continuum—children and the elderly—and people with disabilities are particularly at risk at intersections. These pedestrians often find it more difficult to cross unprotected road crossings, walk at slower speeds than other pedestrians, and generally prefer larger gaps in the traffic stream. Children lack traffic experience, are impulsive, and have less developed cognitive abilities, and their small size limits their visibility. The elderly may have physical limitations including reduced visual acuity, hearing, and mobility.

Crossing at multilane roundabouts is more difficult for all pedestrians, but especially for the more vulnerable users described above. Multilane roundabouts have longer crossing distances and pedestrians need assurance that all lanes are free of moving traffic before they can cross the street. Recent research indicates that two to three times more motorists do not yield to pedestrians at multilane roundabouts than at single-lane roundabouts (3). In addition, pedestrians are faced with the potential for multiple-threat crashes when the driver in the first lane stops to yield to a pedestrian, blocking the sight lines between the pedestrian and any vehicles in the next lane. If neither the driver in the next lane nor the pedestrian sees the other user in time to take evasive action, a crash can occur in the second lane.

2.3.2 PEDESTRIANS WITH DISABILITIES

Pedestrians who are blind or have low vision have several areas of difficulty when crossing a roundabout. It is expected that a pedestrian with vision impairments who has good travel skills should be able to arrive at an unfamiliar intersection and cross it without special intersection-specific training. For pedestrians with vision impairments, roundabouts pose problems at several locations throughout the crossing experience:

- *Wayfinding.* Pedestrians with vision impairments may have trouble finding crosswalks because crosswalks are located outside the projection of approaching side-walks, and the curvilinear nature of roundabouts alters the normal audible and tactile cues they use to find crosswalks. As described in Section 6.8.1, a landscape strip or other detectable edge treatment between sidewalks and roundabouts can help lead all pedestrians to a crosswalk, particularly those who are blind or have low vision.

When crossing a roundabout, there are several areas of difficulty for the blind or visually impaired pedestrian.

- *Alignment.* Likewise, roundabouts do not typically include the normal audible and tactile cues used by pedestrians with vision impairments to align themselves with the crosswalk. This alignment task can be simplified if sidewalk ramps and splitter island cut-through walkways are aligned with the crosswalk and if detectable warnings are installed on curb ramps and splitter islands.
- *Gap and yield detection.* The most critical issue at roundabouts for pedestrians with vision impairments is the fact that the sound of circulating traffic masks the audible cues that blind pedestrians use to identify the appropriate time to enter the crosswalk (both gap detection and yield detection). It may be impossible to determine by sound alone whether a vehicle has actually stopped or intends to stop. This is especially problematic at roundabout exits because without visual confirmation, it is difficult to distinguish a circulating vehicle from an exiting vehicle. At multilane roundabouts, this problem is magnified by the need to assess traffic traveling in multiple directions in multiple lanes. Even if a vehicle in one lane has stopped and a blind pedestrian is able to discern this, the pedestrian will likely have difficulty assessing if motorists have stopped in all lanes of a roundabout exit. Although research has been conducted on other possible solutions and some research is still ongoing, the installation of accessible (audible and vibrotactile) pedestrian signals at roundabout pedestrian crossings has been shown to be a treatment that consistently makes multilane roundabouts accessible to pedestrians who are blind or who have low vision.

Any new or modified intersection in the United States that has pedestrian facilities must be accessible to and usable by all pedestrians per the requirements of the Americans with Disabilities Act (ADA) (4). Under the ADA the public right-of-way is a “program” provided by state and local governments that must not discriminate against pedestrians with disabilities (28 CFR 35.150). Any facility or part of a facility that is newly constructed by a state or local government and that provides pedestrian facilities must be designed and constructed so that it is readily accessible to and usable by people with disabilities [28 CFR 35.151(a)]. Alterations to existing facilities must include modifications to make altered areas accessible to individuals with disabilities [28 CFR 35.151 (b)].

As of this writing, the 1994 ADA Accessibility Guidelines (ADAAG) are the currently adopted standards that apply to the public right-of-way (5). These guidelines, however, do not specifically address how to make roundabouts accessible. Nonetheless, these provisions mean providing information to safely cross streets in accessible format, including at roundabouts.

The agency responsible for creating accessibility guidelines, the United States Access Board, has developed the draft Public Rights-of-Way Accessibility Guidelines (PROWAG), which address many accessibility issues found in the public right-of-way that are not addressed by ADAAG. Accessibility features at roundabouts include sidewalks and crosswalks that meet surface, slope, and clearance requirements; ramps connecting sidewalks and crosswalks; detectable edge treatments at ramps, splitter islands, and between sidewalks and roundabouts to guide pedestrians to crosswalks such as landscaping adjacent to the curb line; and signalized pedestrian crossings.

The Federal Highway Administration has issued a memo stating that “the Draft Guidelines are the currently recommended best practices, and can be considered the state of the practice that could be followed for areas not fully addressed by the present ADAAG standards” (6). These guidelines provide specific design guidance for making roundabouts and other intersections accessible to pedestrians with mobility impairments and vision impairments. The reader should refer to Chapters 6 and 7 for information about accessibility features and design details at roundabouts to improve access for pedestrians with disabilities.

2.3.3 BICYCLISTS

Recent research of roundabouts in the United States has not found any substantial safety problems for bicyclists, as indicated by few crashes being reported in detailed crash reports (3). Nevertheless, roundabouts slow drivers to speeds more compatible with bicycle speeds, while reducing high-speed conflicts and simplifying turn movements for bicyclists. Typical on-road bicyclist speeds are 12 to 20 mph (19 to 32 km/h), so designing roundabouts for circulating traffic to flow at similar speeds will minimize the relative speeds between bicyclists and motorists and thereby improve safety and usability for cyclists. Bicyclists require particular attention in two-lane roundabout design, especially in areas with moderate to heavy bicycle traffic.

As with pedestrians, one of the difficulties in accommodating bicyclists is their wide range of skills and comfort levels in mixed traffic. Some of the least-skilled cyclists will choose to ride on sidewalks both along streets away from roundabouts and at the roundabouts. Since these cyclists are behaving like rolling pedestrians, no specific treatments are necessary at roundabouts besides what are provided for pedestrians. In general, cyclists who have the knowledge and skills to ride effectively and safely on roadways can navigate low-speed single lane roundabouts without much difficulty. The most experienced and skilled on-road cyclists will be comfortable traveling through all roundabouts like other vehicles, even at multi-lane roundabouts.

Single-lane roundabouts are much simpler for cyclists than multilane roundabouts since they do not require cyclists to change lanes to make left turn movements or otherwise select the appropriate lane for their direction of travel. In addition, at single-lane roundabouts, motorists are less likely to cut off cyclists when exiting the roundabout. Therefore, care should be exercised when selecting a multilane roundabout over a single-lane roundabout in the short term, even when long-term traffic predictions suggest that a multilane roundabout may be desirable. In addition, the use of a roundabout with two-lane entries and exits on the major roadway and one-lane entries and exits for the minor roadway can be a good solution to reduce complexity for bicyclists where a roundabout is proposed at an intersection of a major multilane street and a minor street.

Where bicycle lanes or shoulders are used on approach roadways, they should be terminated in advance of roundabouts to merge cyclists into traffic for appropriate circulation with other vehicles. In addition, bicycle lanes should not be located within the circulatory roadway of roundabouts as this would suggest that bicyclists should ride at the outer edge of the circulatory roadway, which can increase crashes with cyclists and both entering and exiting motor vehicles. Because some cyclists

Bicycle lanes are not recommended on the circulatory roadway.

may not feel comfortable traversing some roundabouts in the same manner as other vehicles, bicycle ramps can be provided to allow access to the sidewalk or a shared use path at the roundabout. Bicycle ramps at roundabouts have the potential to be confused as pedestrian ramps, particularly for pedestrians who are blind or who have low vision. Therefore, bicycle ramps should be reserved for those situations where the roundabout complexity or design speed may result in less comfort for some bicyclists. Ramps should not normally be used at urban single-lane roundabouts. More details about bicycle design treatments at roundabouts can be found in Chapter 6.

2.3.4 OLDER DRIVERS

There is a trend in the United States of individuals continuing to drive until an older age than in years past. This trend has implications for all roadway design, including roundabout design, ranging from operations through geometric and sign design. In this regard, designers should consult available documents such as the FHWA *Highway Design Handbook for Older Drivers and Pedestrians* (7), which presents the following considerations for understanding the differences of older drivers and pedestrians with understanding and navigating through intersections.

- The single greatest concern in accommodating older road users, both drivers and pedestrians, is the ability of these persons to safely maneuver through intersections.
- Driving situations involving complex speed–distance judgments under time constraints are more problematic for older drivers and pedestrians than for their younger counterparts.
- Older drivers are much more likely to be involved in crashes where the drivers were driving too fast for the curve or, more significantly, were surprised by the curved alignment.
- Left-turn maneuvers are difficult for older drivers since they have difficulty in selecting acceptable gaps due to reduced ability to judge oncoming speeds and slower response times (8–11). They also have more difficulty understanding left-turn displays (12–14).
- Left-turn crashes are particularly problematic for older drivers. Research has shown that the potential of being involved in left-turn crashes increases with age (15–16).
- Many studies have shown that loss-of-control crashes result from an inability to maintain lateral position through the curve because of excessive speed with inadequate deceleration in the approach zone. These problems stem from a combination of factors, including poor anticipation of vehicle control requirements, induced by the driver's prior speed, and inadequate perception of the demands of the curve.
- Older drivers have difficulties in allocating attention to the most relevant aspects of novel driving situations.
- Older drivers generally need more time than average drivers to react to events.

These findings apply to older drivers and pedestrians encountering all types of intersections, including roundabouts. The excerpts above all imply that lower, more conservative design speeds are appropriate.

Research indicates that roundabouts may address some of the problems drivers experience in dealing with intersections. One of the key design features of a roundabout is that all traffic must slow down as it enters the intersection. Slower speeds can benefit both the novice and older driver as they navigate the roadways. Some of the potential benefits of slower intersection speeds include a reduction in crash severity (for a given crash type), safer merges, and more opportunities to correctly judge and enter gaps (17).

The slower and consistent speeds at roundabouts can cater to the preferences of older drivers by:

- Allowing more time to make decisions, act, and react;
- Providing less complicated situations to interpret;
- Requiring simpler decision-making;
- Reducing the need to look over one's shoulder;
- Reducing the need to judge closing speeds of fast traffic accurately; and
- Reducing the need to judge gaps in fast traffic accurately.

The benefits a roundabout provides to older drivers can be an important factor in reducing the number of crashes at an intersection. For example, two-way stop-controlled intersections may be appropriate for replacement with a roundabout when a crash analysis indicates that age-related crashes are prevalent.

It is important that older drivers understand the key operating characteristics of roundabouts, such as determining a safe approach speed, identifying the number of lanes and which lane to be in, understanding the direction of travel on the circulatory roadway, yielding to vehicles upon entry, and understanding the street/route signs at each exit. Research shows that proper use of roundabout advance warning signs with arrows indicating direction of traffic flow, yield signs, directional signs, and road name signs can improve older drivers' understanding of roundabouts (18). Overhead lane use signs, recommended by the *Highway Design Handbook for Older Drivers and Pedestrians* for signals (7), can aid navigation choices on multilane roundabout approaches.

2.3.5 LARGE VEHICLES

Large vehicles have a direct impact on the design of a roundabout. Single-lane roundabouts often employ a traversable apron around the perimeter of the central island to provide the additional width needed for tracking the trailer wheels of large vehicles. Multilane roundabouts are designed either to allow large vehicles to track across more than one lane while entering, circulating, and exiting or to stay within their lane. In some cases, roundabouts have been designed with aprons or gated roadways through the central island to accommodate over-sized trucks, emergency vehicles, or trains. Details on treatments for large vehicles can be found in Chapter 6.

Design roundabouts to accommodate the largest vehicle that can reasonably be expected.

Buses should not need to use a truck apron to negotiate a roundabout.

Chapters 6 and 7 provide more detail on transit treatments.

2.3.6 TRANSIT

Transit vehicles are a special type of large vehicle and have unique requirements, many of which are similar to those at other types of intersection treatments. If the roundabout has been designed using the appropriate design vehicle, a bus should have no physical difficulty negotiating the intersection. To minimize passenger discomfort, it is preferable for buses to not need to use a truck apron if present. Bus stops should be located carefully to minimize the probability of vehicle queues spilling back into the circulatory roadway. This typically means that bus stops located on the far side of the intersection need to have pullouts or be further downstream than the splitter island, located in a way that is mindful of the bus driver's ability to merge into the traffic stream. Pedestrian access routes to transit should be designed for safety, comfort, and convenience. Pedestrian crossing capacity should be accounted for if demand is significant, such as near a station or terminus.

When combined with signals, roundabouts may provide opportunities for giving transit (including rail) and emergency vehicles priority. For example, these could include signals holding entering traffic while the transit vehicle enters in its own right-of-way or in mixed traffic. Chapters 6 and 7 provide more detail on transit treatments.

2.3.7 EMERGENCY VEHICLES

The passage of large emergency vehicles through a roundabout is the same as for other large vehicles and may require use of a traversable apron. On emergency response routes, the delay for the relevant movements at a planned roundabout should be compared with alternative intersection types and control. Just as they are required to do at conventional intersections, drivers should be educated not to enter a roundabout when an emergency vehicle is approaching on another leg. Once entered, they should clear out of the circulatory roadway if possible, facilitating queue clearance in front of the emergency vehicle.

Roundabouts provide emergency vehicles the benefit of lower vehicle speeds, which may make roundabouts safer for them to negotiate than signalized crossings. Unlike at signalized intersections, emergency vehicle drivers are not faced with through vehicles unexpectedly running the intersection and hitting them at high speed.

2.3.8 RAIL CROSSINGS

Rail crossings through or near a roundabout may involve many of the same design challenges as at other intersections. In retrofit, the rail track may be designed to pass through the central island or across one of the legs. Queues spilling back from a rail blockage into the roundabout can fill the circulatory roadway and temporarily prevent movement on any approach. However, to the extent that a roundabout approach capacity exceeds that of a signal at the same location, queues will dissipate faster. Therefore, a case-specific capacity and safety analysis is recommended. Chapter 7 addresses the design of at-grade rail crossings.

2.4 POLICY AND LEGAL ISSUES

Policy plays an important role in the implementation of roundabouts, particularly at the state level. There are two key aspects to policy implementations:

- Decision-making process and
- Legal issues, including rules of the road.

2.4.1 DECISION-MAKING PROCESS

Many state agencies have developed roundabout policies to help guide designers and planners in making appropriate decisions when considering a roundabout intersection. In some cases, these states have established task forces to establish a policy for implementing roundabouts on state facilities. These policies often include background information about the geometric, safety, and operational characteristics of roundabouts; example locations where roundabouts may be considered; operational and safety evaluation discussions; and an overview of the trade-offs and general considerations for this type of intersection control.

Some states have made internal decisions about prioritizing the way roundabouts are used compared to other traditional intersection types. Some have adopted a “roundabout first” policy that requires designers and planners to consider roundabouts as a first priority during any intersection improvements or construction. Other states encourage designers or planners to only use roundabouts as solutions to unique situations. Some states have developed their own roundabout guidelines and standards, including Kansas, New York, Washington, and Wisconsin. These allow states to include design, operation, and planning information that is specific to their state practices and policies. Where there are no specific state guidelines, the guidance provided in this document is typically used.

As jurisdictions continue to implement roundabouts, all users need to understand their unique features and operational characteristics, including safety, relationship to signal progression, environmental factors, spatial requirements, operation and maintenance costs, traffic calming effects, aesthetics, and access management benefits.

2.4.2 RULES OF THE ROAD

The legal environment in which roundabouts operate is an important area for jurisdictions to consider when developing a roundabout program or set of guidelines. The rules of the road that govern the operation of motor vehicles in a given state can have a significant influence on the way a roundabout operates and on how legal issues, such as crashes involving roundabouts, are handled. Local jurisdictions that are building roundabouts should be aware of the governing state regulations in effect.

The 2000 Uniform Vehicle Code (UVC) is the primary resource guidance pertaining to roadways and intersections. However, the UVC does not provide specific guidance for roundabouts. Some states have begun to update their state code to include guidance for roundabouts. For example, in Oregon, Chapter 811—Rules of

The Road of the Oregon Revised Statutes (ORS 811.400) (19) creates certain traffic procedures for roundabouts; creates offense of failure to yield right-of-way within a roundabout; modifies offense of failure to use the appropriate signal for turns, lane changes, or stops to include exiting from a roundabout; and defines a roundabout and circulatory roadway.

Further detail can be found in Appendix C.

2.5 REFERENCES

1. Brown, M. *TRL State of the Art Review: The Design of Roundabouts*. HMSO, London, 1995.
2. Niederhauser, M. E., B. A. Collins, and E. J. Myers. "The Use of Roundabouts: Comparison with Alternate Design Solution." In *Compendium of Technical Papers for the 67th ITE Annual Meeting*, Boston, Institute of Transportation Engineers, Washington, D.C., 1997.
3. Rodegerdts, L., M. Blogg, E. Wemple, E. Myers, M. Kyte, M. Dixon, G. List, A. Flannery, R. Troutbeck, W. Brilon, N. Wu, B. Persaud, C. Lyon, D. Harkey, and D. Carter. *NCHRP Report 572: Roundabouts in the United States*. Transportation Research Board of the National Academies, Washington, D.C., 2007.
4. Americans with Disabilities Act. www.ada.gov/pubs/ada.htm. Accessed March 2009.
5. Americans with Disabilities Act Accessibility Guidelines. www.access-board.gov/adaag/html/adaag.htm. Accessed March 2009.
6. Isler, F. D. "INFORMATION: Public Rights-of-Way Access Advisory." Memo from FHWA Associate Administrator for Civil Rights to Division Administrators, Resource Center Directors, and Federal Lands Highway Division Engineers. January 23, 2006. www.fhwa.dot.gov/environment/bikeped/prwaa.htm. Accessed January 19, 2009.
7. Staplin, L., K. Lococo, S. Byington, and D. Harkey. *Highway Design Handbook for Older Drivers and Pedestrians*. Publication No. FHWA-RD-01-103. FHWA, Washington, D.C., May 2001.
8. *Traffic Maneuver Problems of Older Drivers: Final Technical Report*. Publication No. FHWA-RD-92-092. FHWA, Washington, D.C., 1993.
9. Staplin, L. "Simulator and Field Measures of Driver Age Differences in Left-Turn Gap Judgments." *Transportation Research Record 1485*. TRB, National Research Council, Washington, D.C., 1995, pp. 49–55.
10. Scialfa, C. T., L. T. Guzy, H. W. Leibowitz, P. M. Garvey, and R. A. Tyrrell. "Age Differences in Estimating Vehicle Velocity." *Psychology and Aging*, Vol. 6, No. 1, 1991, pp. 60–66.
11. Oxley, J., B. Corben, and B. Fildes. "Older Driver Highway Design: The Development of a Handbook and Training Workshop to Design Safe Road

- Environments for Older Drivers." *Proc., Traffic Safety on Three Continents Conference*, Moscow, Russia, 2001.
12. Williams, J. C., S. A. Ardekani, and S. Adu Asante. "Motorist Understanding of Left-Turn Signal Indications and Auxiliary Signs." *Transportation Research Record 1376*. TRB, National Research Council, Washington, D.C., 1992, pp. 57–63.
 13. Drakopoulos, A. and R. W. Lyles. "Driver Age as a Factor in Comprehension of Left-Turn Signals." *Transportation Research Record 1573*. TRB, National Research Council, Washington, D.C., 1997, pp. 76–85.
 14. Noyce, D. A. and K. C. Kacir. "Drivers' Understanding of Protected-Permitted Left-Turn Signal Displays." *Transportation Research Record 1754*. TRB, National Research Council, Washington, D.C., 2001, pp. 1–10.
 15. Garber, N., and R. Srinivasan. "Characteristics of Accidents Involving Elderly Drivers at Intersections." *Transportation Research Record No. 1325*, TRB, National Research Council, Washington, D.C., 1991, pp. 8–16.
 16. Matthias, J., M. De Nicholas, and G. Thomas. *A Study of the Relationship between Left Turn Accidents and Driver Age in Arizona*. Report No. AZ-SP-9603. Arizona Department of Transportation, Phoenix, Arizona, 1996.
 17. Stutts, J. *NCHRP Synthesis 348: Improving the Safety of Older Road Users*. Transportation Research Board of the National Academies, Washington D.C., 2005.
 18. Lord, D., I. van Schalkwyk, L. Staplin, and S. Chrysler. *Reducing Older Driver Injuries at Intersections Using More Accommodating Roundabout Design Practices*. Texas Transportation Institute, College Station, Texas, 2005.
 19. State of Oregon. Oregon Revised Statute 811.400. www.leg.state.or.us/ors/811.html. Accessed March 2009.

CHAPTER 3 PLANNING

CONTENTS

3.1 INTRODUCTION	3-4
3.2 PLANNING STEPS	3-5
3.3 CONSIDERATIONS OF CONTEXT	3-6
3.3.1 Decision Environments	3-7
3.3.2 Site-Specific Conditions	3-8
3.4 POTENTIAL APPLICATIONS	3-10
3.4.1 New Residential Subdivision	3-11
3.4.2 Urban Centers	3-12
3.4.3 Suburban Municipalities and Small Towns	3-13
3.4.4 Rural Settings and Small Communities	3-14
3.4.5 Schools	3-15
3.4.6 Interchanges	3-16
3.4.7 Gateway and Traffic Calming Treatments	3-16
3.4.8 Commercial Developments	3-17
3.4.9 Unusual Geometry	3-19
3.4.10 Closely Spaced Intersections	3-20
3.5 PLANNING-LEVEL SIZING AND SPACE REQUIREMENTS	3-20
3.5.1 Planning Estimates of Lane Requirements	3-21
3.5.2 Mini-Roundabouts	3-24
3.5.3 Space Requirements	3-26
3.5.4 Design Considerations	3-27
3.6 COMPARING PERFORMANCE OF ALTERNATIVE INTERSECTION TYPES	3-30
3.6.1 Two-Way Stop-Control Alternative	3-31
3.6.2 All-Way Stop-Control Alternative	3-32
3.6.3 Signal Control Alternative	3-32

3.7 ECONOMIC EVALUATION	3-33
3.7.1 Methodology	3-34
3.7.2 Estimating Benefits	3-35
3.7.3 Estimation of Costs	3-37
3.8 PUBLIC INVOLVEMENT	3-38
3.8.1 Audience	3-39
3.8.2 Content	3-39
3.8.3 Public Meetings	3-39
3.8.4 Informational Brochures	3-40
3.8.5 Websites	3-41
3.8.6 Informational Videos	3-43
3.8.7 Media Announcements	3-44
3.8.8 User Education	3-44
3.9 REFERENCES	3-45

LIST OF EXHIBITS

Exhibit 3-1	Planning Framework	3-5
Exhibit 3-2	Residential Subdivision	3-11
Exhibit 3-3	Urban Center	3-12
Exhibit 3-4	Small Town/Municipality	3-13
Exhibit 3-5	Rural Setting	3-14
Exhibit 3-6	Schools	3-15
Exhibit 3-7	Interchanges	3-16
Exhibit 3-8	Gateway Treatment	3-17
Exhibit 3-9	Commercial Developments	3-18
Exhibit 3-10	Unusual Geometry	3-19
Exhibit 3-11	Closely Spaced Intersections	3-20
Exhibit 3-12	Planning-Level Daily Intersection Volumes	3-22
Exhibit 3-13	Traffic Flows at a Roundabout Entry	3-23
Exhibit 3-14	Volume Thresholds for Determining the Number of Entry Lanes Required	3-23
Exhibit 3-15	Example Planning-Level Exercise for Determining Required Numbers of Lanes Using Turning-Movement Data	3-24
Exhibit 3-16	Planning-Level Maximum Daily Service Volumes for Mini-Roundabouts	3-25
Exhibit 3-17	Area Comparison: Single-Lane Roundabout versus Comparable Signalized Intersection	3-27
Exhibit 3-18	Area Comparison: Multilane Roundabout versus Comparable Signalized Intersection	3-28
Exhibit 3-19	Average Control Delay per Vehicle at the MUTCD Peak-Hour Signal Warrant Thresholds	3-33
Exhibit 3-20	Estimated Costs for Crashes of Varying Levels of Severity	3-36
Exhibit 3-21	Example of Public Information Poster	3-40
Exhibit 3-22	Examples of Scale Roundabout Models for Public Involvement	3-41
Exhibit 3-23	Examples of Project-Specific Informational Brochures	3-42
Exhibit 3-24	Example of General Informational Brochure	3-42
Exhibit 3-25	Examples of Roundabout Websites	3-43

3.1 INTRODUCTION

At the planning stage, there are a variety of possible reasons or goals for considering a roundabout at a particular intersection. In some states, consideration of a roundabout alternative is a requirement of all intersection analyses. Meanwhile, other locations may have a specific reason for evaluating a roundabout as an alternative, including improving safety or operations, improving aesthetics, assisting with access management, or promoting redevelopment. However, whatever the reasons for considering a roundabout, a number of common considerations should be addressed at the planning level:

- Is a roundabout appropriate for this location?
- How big should it be or how many lanes might be required?
- What sort of impacts might be expected?
- What public education and outreach might be appropriate?

Planning determines whether a roundabout is even feasible, before expending the effort required for more detailed analysis and design.

Chapter 1 presented a range of roundabout categories and suggested typical daily service volume thresholds below which four-leg roundabouts may be expected to operate, without requiring a detailed capacity analysis. Chapter 2 introduced roundabout performance characteristics, including comparisons with other intersection forms and control, which will be expanded upon in this chapter. This chapter covers the next steps that lead to the decision as to whether a roundabout is a feasible alternative. By confirming that there is good reason to believe that roundabout construction is feasible and that a roundabout is the best alternative, these planning activities avoid expending unnecessary effort required in more detailed steps.

The initial steps in planning for a roundabout are to clarify the objectives and understand the context in which the roundabout is being considered. The next step is to specify a preliminary configuration. This identifies the minimum number of lanes required on each approach and thus which type of roundabout is the most appropriate to use as a basis for design: mini, single-lane, or multilane. Given sufficient space, roundabouts can be designed to accommodate high traffic volumes. There are many additional levels of detail required in the design and analysis of a high-capacity, multilane roundabout that are beyond the scope of a planning-level procedure; these are given in later chapters. Therefore, this chapter focuses on the more common questions that can be answered using reasonable assumptions and approximations.

Feasibility analysis requires an approximation of some of the design parameters and operational characteristics. Depending on the specific situation, it may be necessary to explore beyond base-level approximations with respect to one or more key attributes of the roundabout to ensure compatibility and feasibility. Consideration must also be given to the potential trade-offs between safety, operations, and design when planning for roundabouts. Particularly in the early stages of planning, these key aspects and their impacts on one another can help determine a roundabout's feasibility. Some changes in these approximations may be necessary as the design evolves. A more detailed methodology for

performing the operational evaluation and geometric design tasks is presented later in Chapters 4 and 6 of this guide, respectively.

3.2 PLANNING STEPS

Exhibit 3-1 outlines many of the considerations that may need to be investigated prior to deciding whether to implement a roundabout at an intersection. Note that this is not intended to be all-encompassing, nor is it intended to reflect minimum

Exhibit 3-1
Planning Framework

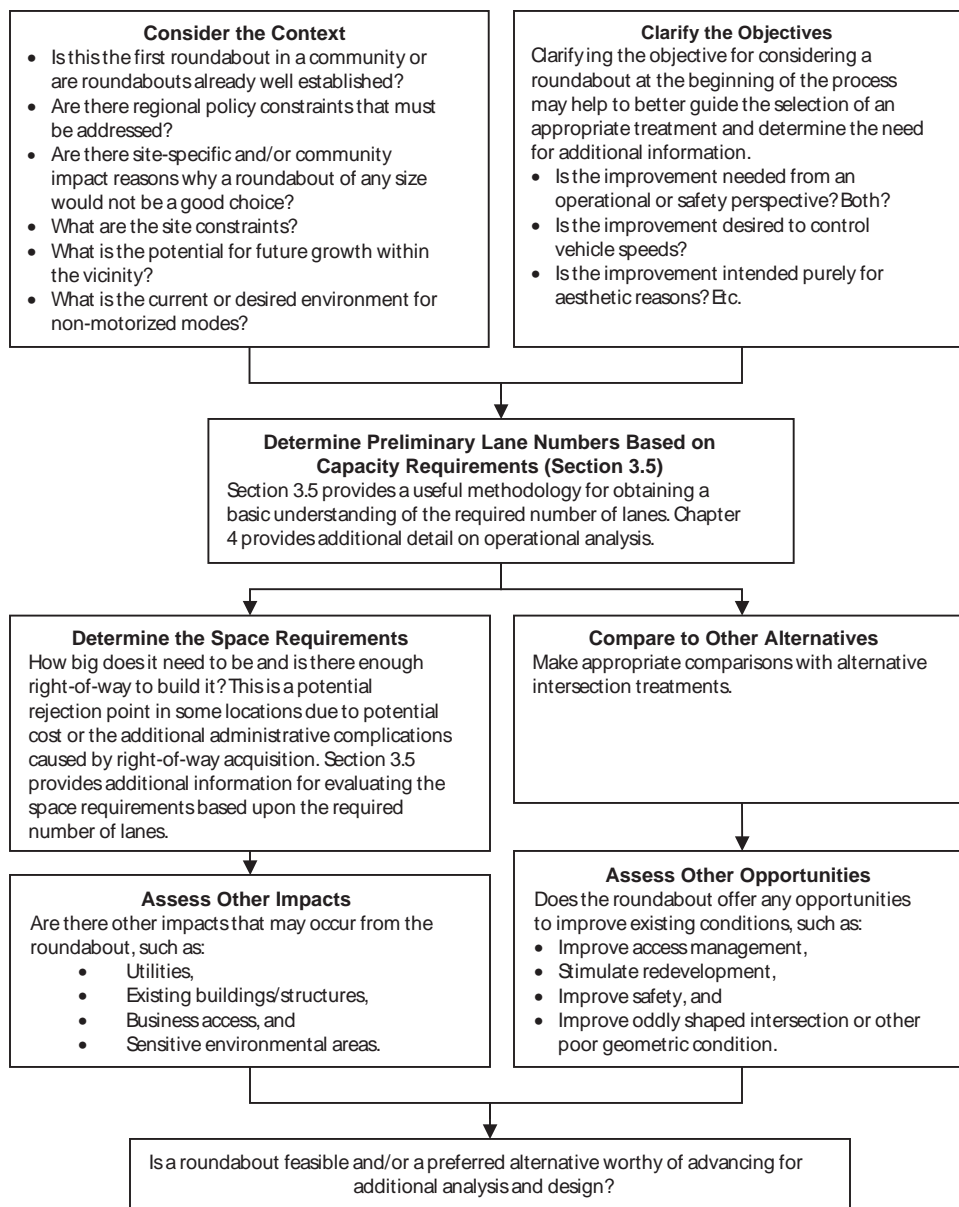

Suggested contents of a roundabout feasibility study report.

requirements. Rather, it is intended to provide a general framework for the steps typically necessary in identifying feasibility.

The results of the steps above should be documented to some extent. The level of detail in the documentation will vary among agencies and will be influenced by the size and complexity of the roundabout. A roundabout feasibility study report may include the following elements:

- It may identify why a roundabout is being considered as an improvement alternative at this intersection.
- It may identify the current status of traffic operations and safety at the intersection for comparison with expected roundabout performance.
- It may identify a conceptual roundabout configuration, which includes the number of lanes on each approach and the designation of those lanes.
- It may demonstrate whether an appropriately sized and configured roundabout can be implemented feasibly.
- It may identify all potential complicating factors, assess their relevance to the location, and identify any mitigation efforts that might be required.

Where more complete or formal rationale is necessary, the roundabout feasibility study report may also include the following additional considerations:

- It may demonstrate institutional and community support, indicating that key institutions (e.g., police, fire department, and schools) and key community leaders have been consulted.
- It may give detailed performance comparisons (including delay, capacity, emissions, and/or interaction effects with nearby intersections) of the roundabout with alternative control modes.
- It may include an economic analysis indicating that a roundabout compares favorably with alternative control modes from a benefit–cost perspective.
- It may include a detailed discussion about potential trade-offs between safety, operations, and design.
- It may include detailed appendices containing traffic volume data, signal or all-way stop-control warrant analysis, and so on.

3.3 CONSIDERATIONS OF CONTEXT

Adherence to sound planning and engineering principles will ensure that the decision to install a roundabout in a specific location is made appropriately. This guide focuses on principles, recognizing that each specific case or instance brings with it a myriad of unique opportunities and challenges.

3.3.1 DECISION ENVIRONMENTS

The decision process for considering a roundabout can be significantly influenced by the environment in which the roundabout is being considered. While the same basic analysis tools and concepts apply to all environments, the relative importance of the various aspects and observations may differ, as may other policy decisions. At least three environments present unique opportunities and challenges for roundabout implementation: roundabouts in a new roadway system, the first roundabout in an area, and a retrofit of an existing intersection.

A new roadway system. Fewer constraints are imposed if the location under consideration is not a part of an existing roadway system. Right-of-way is usually easier to acquire or commit. Other intersection forms also offer viable alternatives to roundabouts. There are often no field observations of site-specific problems that must be addressed. This situation is more commonly faced by private development than by public agencies, and thus coordination between private and public interests in the planning, analysis, and design of the roundabout becomes important.

The first roundabout in an area. The first roundabout in any geographic area often faces significantly higher levels of public interest, if not apprehension, in the concept of a roundabout, and an early failure of the process could take years to recover from. This situation requires an implementing agency to be diligent regarding operational and design aspects of roundabouts, community impacts, user needs, and public acceptability, and to work interactively with the public and elected officials in communicating those aspects. On the other hand, a successfully implemented roundabout, especially one that solves a demonstrated problem, could be an important factor in gaining support for future roundabouts at appropriate locations. Some important considerations for this decision environment include the following:

- Efforts should be directed toward gaining community and institutional support for the selection of a site for the first roundabout in an area. Public acceptance, as for any complex project, requires agency staff to understand the potential issues and communicate these effectively with the impacted community.
- An extensive justification effort may be necessary to gain the required support, accomplished through one or several of the techniques outlined in Section 3.8 (Public Involvement).
- A cautious and conservative approach may be appropriate; careful consideration should be given to conditions that suggest that the benefits of a roundabout might not be fully realized. Collecting data on current users of the intersection can provide important insights regarding potential issues and design needs.
- A single-lane roundabout in the near-term is more easily understood by most drivers and therefore may have a higher probability of acceptance by the motoring public. However, in several communities throughout the United States, multilane roundabouts have been quite successful as the first roundabouts within the area. A focus on good design and public education is important when considering a multilane roundabout.

Will the roundabout be:

- Part of a new roadway?
- The first in an area?
- A retrofit of an existing intersection?

The first roundabout in an area may require greater education and justification efforts. Single-lane roundabouts will generally be more easily understood initially than multilane roundabouts.

- The choice of design and analysis procedures could set a precedent for future roundabout implementation; therefore, the full range of design and analysis alternatives should be explored in consultation with other operating agencies in the region.
- After the roundabout is constructed, evaluating and documenting its operation and the public response could support future installations.

Many agencies that are contemplating the construction of their first roundabout have a natural tendency to keep the roundabout as simple as possible. This typically means jurisdictions are reluctant to introduce multilane roundabouts until single-lane roundabouts have gained some success. It is also a common desire to avoid intersection designs that require additional right-of-way because of the effort and expense involved in right-of-way acquisition. Important questions to be addressed in the planning phase are therefore:

- Will a minimally configured roundabout (i.e., single-lane entrances and circulatory roadway) provide adequate capacity and performance for all users, or will additional lanes be required on some legs or at some future time?
- Can the roundabout be constructed within the existing right-of-way, or will it be necessary to acquire additional space beyond the property lines?
- If additional right-of-way is indeed required at the intersection to construct a roundabout, are there opportunities to reduce the overall cross section of the adjacent roads to offset the impact and provide a benefit to properties near the roundabout?
- Can a single-lane roundabout be designed for economical future expansion to accommodate growth?

Retrofit to an existing intersection in an area where roundabouts have already gained acceptance. This environment is one in which a solution to a site-specific problem is being sought. Communities with experience limited to single-lane roundabouts may now be comfortable pursuing opportunities to use higher-capacity multilane roundabouts. Within the region, design and evaluation procedures may also be better defined than in communities that are exploring their first roundabouts. The basic objectives of the selection process in this case are to demonstrate how the community will be affected and that a roundabout will function properly during the peak period within the capacity limits imposed by the space available, and to decide which one is the preferred alternative. If the required configuration involves additional right-of-way, a more detailed analysis will probably be necessary using the methodology described in Chapter 4.

3.3.2 SITE-SPECIFIC CONDITIONS

Within the context of evaluating intersection alternatives, each individual location has its own unique characteristics, issues, and objectives for improvement. The optimal control choice will be the one that best balances those objectives. Roundabouts offer benefits under many circumstances; however, they may also be more complicated to implement in comparison to other control types. The following discussion identifies several site-related factors that may significantly influence a

roundabout design. These factors should be taken into consideration when comparing alternatives and how well each balances the improvement objectives:

- Physical or geometric complications may significantly influence a roundabout's design and may make a roundabout infeasible or uneconomical. These could include right-of-way limitations, grades or unfavorable topography, utility conflicts, drainage problems, intersection skew, and so on.
- Designated routes or proximity of generators of significant types of traffic may result in vehicles with difficulty negotiating the roundabout, such as oversized trucks (also known as "superloads"). At the planning stage, the evaluation of the space requirement may warrant the consideration of a larger footprint to accommodate high volumes of oversized vehicles.
- Other nearby traffic control devices requiring preemption, such as at-grade rail crossings, could create queuing interactions with the roundabout that need to be addressed.
- Nearby bottlenecks could routinely back up traffic into the roundabout, such as over-capacity signals or drawbridges. The successful operation of a roundabout depends on unimpeded flow on the circulatory roadway. If traffic on the circulatory roadway comes to a halt, momentary intersection gridlock can occur. In comparison, other intersection treatments may have fewer adverse effects under those conditions.
- Intersections of a major arterial and a minor arterial or local road could create an unacceptable delay to the major road. Roundabouts delay and deflect all traffic entering the intersection and could introduce excessive delay or speed inconsistencies to flow on the major arterial.
- Heavy pedestrian or bicycle movements could conflict with high motor vehicle traffic volumes.
- In situations with intersections located on arterial streets within a coordinated signal network, the level of service on the arterial might be better with a signalized intersection operating in coordination to minimize arterial through movement delay.

The existence of one or more of these conditions does not necessarily preclude the installation of a roundabout. Roundabouts have, in fact, been built at locations that exhibit nearly all of the conditions listed above. Such factors may be resolved in several ways:

- They may be determined to be insignificant at the specific site;
- They may be resolved by operational modeling or by adding specific design features;
- They may be resolved through coordination with and support from other agencies, such as the local fire department, school district, and so forth; or
- In some cases, specific design treatments may be required to address concerns.

It may be easier to install the first roundabout in an area in a location with the fewest complications. On the other hand, a successful roundabout in a complicated area can often make subsequent roundabouts easier to install.

While not every complicating factor needs to be completely resolved prior to the choice of a roundabout as the preferred intersection alternative, each should have a reasonable certainty of resolution to ensure a successful project.

The effect of a particular factor will often depend on the degree to which roundabouts have been implemented in the region. There are conditions that would not be expected to pose problems in areas in which roundabouts are an established form of intersection control that is accepted by the public. On the other hand, some conditions may suggest that the installation of a roundabout be deferred until this control mode has demonstrated regional acceptance. Most agencies have an understandable reluctance to introduce complications at their first roundabout.

3.4 POTENTIAL APPLICATIONS

Roundabouts serve as one potential tool within the toolbox of intersection control options and should be considered in a wide array of possible applications. There are numerous reasons for selecting a roundabout as a preferred alternative, with each reason carrying its own considerations and trade-offs. This section provides a cursory overview of several example locations or situations where roundabouts are often considered. It also highlights situations where trade-offs may exist or certain aspects of the overall roundabout design may require further investigation to determine the feasibility of a roundabout and whether it is the preferred alternative.

Strategies and methods to address potential issues associated with these and other applications with respect to operations, safety, and geometric design of roundabouts can be found in Chapters 4, 5, and 6, respectively.

3.4.1 NEW RESIDENTIAL SUBDIVISION

Developers have begun to use roundabouts in residential subdivisions with increasing frequency (see Exhibit 3-2). Roundabouts provide a variety of operational and aesthetic benefits and create a sense of place that is attractive to developers and homeowners.



Denver, Colorado

Exhibit 3-2
Residential Subdivision

Benefits	Considerations
<ul style="list-style-type: none"> • Calming effect on traffic promotes lower travel speeds • Aesthetic benefits (community enhancement/gateway treatment) • Single-lane roundabout often appropriate given relatively low traffic volumes within neighborhoods • Pedestrian and bicycle friendly 	<ul style="list-style-type: none"> • Design vehicle (emergency/fire, garbage, large moving trucks) • Right-of-way needs • Driveway access to corner properties • Landscaping • Illumination

3.4.2 URBAN CENTERS

Urban settings (see Exhibit 3-3) are active areas and typically have a mix of competing considerations and users—passenger cars, buses, emergency vehicles, trucks, pedestrians, and bicyclists—throughout the day, all in a constrained environment. Roundabouts may be considered an optimal choice in situations where existing or planned access-management strategies along a corridor facilitate U-turn movements at nearby intersections. Roundabouts accommodate U-turns without requiring tight turning radii for vehicles or introducing significant amounts of delay to left-turning vehicles at conventional intersections.

Exhibit 3-3
Urban Center



Annapolis, Maryland

Benefits	Considerations
<ul style="list-style-type: none"> • Promotes lower vehicular speeds and can reduce delay and emissions • Enhances pedestrian safety • Provides for aesthetic treatments (monuments, landscaping, etc.) • Low maintenance (no signals, detector loops) • Complementary to access management programs 	<ul style="list-style-type: none"> • Design vehicle • Right-of-way needs • Accessibility for pedestrians who are blind or have low vision • Emergency vehicle access/parking • Roadway system operations (e.g., interaction with adjacent signals) • Sight distance

3.4.3 SUBURBAN MUNICIPALITIES AND SMALL TOWNS

Smaller municipalities are often ideal locations to consider roundabouts (see Exhibit 3-4). Right-of-way is often less constrained, traffic volumes are lower, and the aesthetic opportunities for landscaping and gateway treatments are enticing. Existing operational and/or safety deficiencies can also often be addressed.



Brunswick, Maryland

Exhibit 3-4
Small Town/Municipality

Benefits	Considerations
<ul style="list-style-type: none"> • May improve operations and decrease delay compared to two-way stop-control (TWSC) or signalized control • May provide a safer alternative to signalized control for locations where TWSC fails but minor street volumes remain relatively low • May address an existing safety deficiency • Lower speeds • Lower maintenance costs 	<ul style="list-style-type: none"> • Design vehicle • Pedestrian, bicycle, and transit access • Central island maintenance • Intersection visibility under high speed conditions

3.4.4 RURAL SETTINGS AND SMALL COMMUNITIES

Rural settings typically have different needs than urban centers or larger communities. Safety may often be the driving factor over capacity in making a roundabout an appealing choice. Within small communities along an extended highway, a roundabout is ideal for supporting speed reductions. Roundabouts have been demonstrated to be a particularly effective treatment in reducing fatalities and injuries at intersections on high-speed roadways.

Roundabouts located on high speed roadways, particularly in rural settings (see Exhibit 3-5), may require additional design modifications to slow drivers in advance of the intersection. These can include geometric design features such as extended splitter islands and introducing horizontal curvature on high-speed approaches to slow drivers, using the physical alignment of the roadway rather than speed zones (signs) and other passive methods.

Exhibit 3-5
Rural Setting



Clackamas County, Oregon

Benefits	Considerations
<ul style="list-style-type: none"> • May improve operations and decrease delay compared to TWSC or signalized control • May provide safer alternative to signalized control for locations where TWSC fails but minor street volumes remain relatively low • May address an existing safety deficiency • Lower speeds • Lower maintenance costs 	<ul style="list-style-type: none"> • Design vehicle • Pedestrian, bicycle and transit access • Central island maintenance • Intersection visibility under high speed conditions • Illumination

3.4.5 SCHOOLS

Roundabouts may be an optimal choice for intersection control in the vicinity of schools (see Exhibit 3-6). One primary benefit is the reduction of vehicle speeds in and around the roundabout. Roundabouts improve pedestrian crossing opportunities, providing mid-block refuge and the ability for pedestrians to focus on one traffic stream at a time while crossing. Lower speeds also reduce the severity of vehicle–pedestrian crashes. Near schools, single-lane roundabouts are generally preferable to multilane roundabouts due to simpler crossings for children. However, if the traffic volume is sufficiently high, a multilane roundabout may still be preferable to a large signalized intersection.



Clearwater, Florida

Exhibit 3-6
Schools

Benefits	Considerations
<ul style="list-style-type: none"> • Lower vehicle speeds in and around intersection • Improved pedestrian and vehicle safety • Landscaping and gateway treatment 	<ul style="list-style-type: none"> • Design vehicle (school bus, emergency vehicles) • Right-of-way • User education and outreach • If crossing guards are used, the distance between crosswalks may require two crossing guards instead of one.

3.4.6 INTERCHANGES

Interchange ramp terminals are potential candidates for roundabout intersection treatment (see Exhibit 3-7). This is especially true if the subject interchange typically has a high proportion of left-turn flows from the off-ramps and to the on-ramps during certain peak periods, combined with limited queue storage space on the bridge crossing, off-ramps, or cross street approaches. Roundabouts at ramp terminals may also reduce the required width and/or length of bridges, providing a significant cost benefit.

Exhibit 3-7
Interchanges



Gig Harbor, Washington

Benefits	Considerations
<ul style="list-style-type: none"> • Lower vehicle speeds and reduced speed differential through interchange area • Narrower bridge cross section—reduced cost • Landscaping and gateway treatments 	<ul style="list-style-type: none"> • Design vehicle (trucks, emergency vehicles) • Right-of-way • Signing and wayfinding • Driver familiarity

3.4.7 GATEWAY AND TRAFFIC CALMING TREATMENTS

Roundabouts have been used as a part of a community enhancement project and not necessarily as a solution to capacity or safety problems. Such projects are often located in commercial and civic districts as a gateway treatment (see Exhibit 3-8) to convey a change of environment and to encourage traffic to slow down. A roundabout may also be appropriate as a traffic calming measure when the following conditions are present:

- Documented observations of speeding, high traffic volumes, or careless driving activities;

The planning focus for community enhancement roundabouts should be to demonstrate that they will not create traffic problems that do not now exist.

- Inadequate space for roadside activities, or a need to provide slower, safer conditions for both vehicular and non-automobile users; or
- New construction (road opening, traffic signal, new road, etc.) that would potentially increase the volumes of cut-through traffic.

Roundabouts proposed as gateway treatments often require less rigorous analysis as a traffic control device. The main focus of roundabouts proposed as traffic calming features should be to demonstrate that they would not introduce traffic problems that do not currently exist. Particular attention should be given to any complications that could induce operational or safety problems.

Conditions that traffic calming roundabouts may address.



Naples, Florida

Exhibit 3-8
Gateway Treatment

Benefits	Considerations
<ul style="list-style-type: none"> • Central island provides ample space for aesthetic treatments • Minimal impact to traffic operations • Increases landscaping opportunities 	<ul style="list-style-type: none"> • Design vehicle (trucks, emergency vehicles) • Right-of-way

Mini-roundabouts can be appropriate for traffic calming purposes at local street intersections or intersections of minor collectors and local streets. Small, single-lane roundabouts are typically preferable for traffic calming purposes at intersections of two collector streets. Traffic volumes are typically well below the thresholds for single-lane roundabouts discussed in Section 3.5.

3.4.8 COMMERCIAL DEVELOPMENTS

Roundabouts in commercial developments provide for a central focus point for a development and enhance aesthetic qualities (see Exhibit 3-9). They are also able to process high volumes of traffic when properly designed.

Roundabouts: An Informational Guide

Exhibit 3-9
Commercial Developments



Westminster, Colorado

Benefits	Considerations
<ul style="list-style-type: none"> • Introduce geometric delay to slow drivers • Improve safety of both vehicular and non-automobile users • Landscaping opportunities can enhance local neighborhoods • Where a series of roundabouts is used, the roundabouts allow for easy U-turn movements, so minor commercial driveways can easily be restricted to right-in, right-out, improving safety between intersections as well. 	<ul style="list-style-type: none"> • Design vehicle (emergency vehicles, moving trucks) • Right-of-way • Access to adjacent properties into or near the roundabout

3.4.9 UNUSUAL GEOMETRY

Intersections with unusual geometric configurations, intersection angles, or more than four legs are often difficult to manage operationally (see Exhibit 3-10). Roundabouts are a proven traffic control device in such situations, effectively managing traffic flows without the need for costly expenditures on unique signal controller equipment or unusual signal timing.



Colville, Washington

Exhibit 3-10
Unusual Geometry

Benefits	Considerations
<ul style="list-style-type: none"> • Effectively manage traffic flows in situations with unique geometric conditions • Reduced delay compared to signalized scenarios 	<ul style="list-style-type: none"> • Design vehicle (trucks, emergency vehicles) • Right-of-way • Entry path deflection and alignment

3.4.10 CLOSELY SPACED INTERSECTIONS

Roundabouts balance traffic flows and manage queue lengths between closely spaced intersections. The example shown in Exhibit 3-11 serves as the intersection of three streets configured into a pair of roundabouts.

Exhibit 3-11
Closely Spaced Intersections

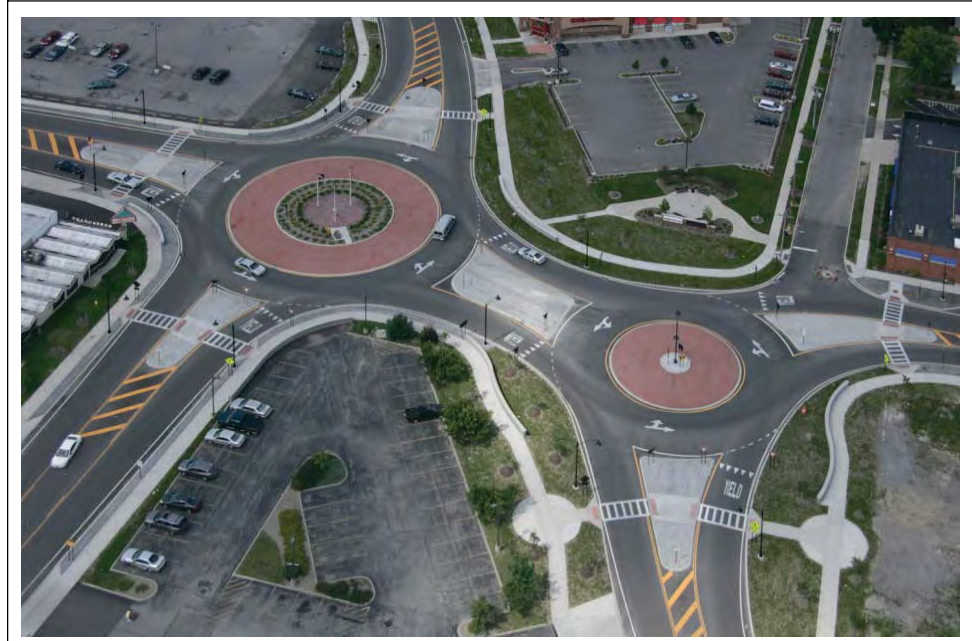

Buffalo, New York

Benefits	Considerations
<ul style="list-style-type: none"> • Reduce queues and balance traffic flow • Accommodate range of access (public and private) 	<ul style="list-style-type: none"> • Capacity analysis needed to confirm operations • Right-of-way

3.5 PLANNING-LEVEL SIZING AND SPACE REQUIREMENTS

Numbers of lanes and space requirements are important planning analysis results.

This section discusses planning-level techniques to determine the type of roundabout. Capacity and size are interrelated based on the number of lanes that will be required to accommodate the forecast traffic volumes. Section 3.5.1 provides a method for determining necessary lanes based on average annual daily traffic (AADT) volume data or a more refined method using turning-movement volumes. Planning-level capacity information for mini-roundabouts is provided in Section 3.5.2. Based upon the identified number of lanes required for the roundabout, the size and general footprint can be estimated using information provided in Section 3.5.3. Additional design considerations that correspond to the required size of the roundabout are provided in Section 3.5.4.

In general, single-lane roundabouts have a number of benefits over larger multilane roundabouts, including improved safety performance, simpler navigation for pedestrian and bicycle users, smaller footprints, and ease of use for motorists. Therefore, practitioners should reconsider the traditional transportation planning technique of using a 20-year traffic horizon for sizing a roundabout. If design-year traffic volumes indicate the need for a multilane roundabout but this need is not likely for several years, consideration should be given to phasing in the roundabout implementation so that it can be built initially as a single-lane roundabout. However, it should also be designed to be readily expandable to a multilane roundabout if the traffic volumes actually increase as predicted. Chapter 6 provides additional discussions regarding the design of roundabouts for expandability.

3.5.1 PLANNING ESTIMATES OF LANE REQUIREMENTS

A basic question that needs to be answered at the planning level is how many lanes are required throughout a roundabout to serve the traffic demand. The number of lanes not only affects the capacity of the roundabout but also its size. This section provides planning-level considerations for the purpose of the initial screening of roundabout feasibility. More detailed operational analyses (Chapter 4) may be required at later stages to confirm the planning level findings. Some assumptions and approximations have been necessary in this chapter to produce a planning-level approach.

High-level planning often requires an initial screening of alternatives where turning-movement data may not be available but AADT volumes are known. Exhibit 3-12 presents ranges of AADT volumes to identify scenarios under which single- and two-lane roundabouts may perform adequately. A range of left turns from 0% to 40% of the total volume is an input to Exhibit 3-12 to improve the prediction of the potential capacity. The percentage of left turns on any given approach affects the conflicting volumes on other entries. Therefore, the potential capacity of the roundabout is reduced as the percentage of left turns increases.

Within Exhibit 3-12, four general ranges of volumes are identified. These ranges represent volume thresholds where one-lane or two-lane roundabouts should operate acceptably and ranges of volumes over which more detailed analysis is required. This procedure is offered as a simple, conservative method for estimating roundabout lane requirements. As an example, if the twenty-four-hour volumes fall within the lowest range of volumes indicated in Exhibit 3-12, a single-lane roundabout should have no operational problems at any time of the day. This graph is applicable for the following conditions, with other conditions requiring more detailed analysis:

- Ratio of peak-hour to daily traffic (K) of 0.09 to 0.10,
- Direction distribution of traffic (D) of 0.52 to 0.58,
- Ratio of minor street to total entering traffic of 0.33 to 0.50, and
- Acceptable volume-to-capacity ratio of 0.85 to 1.00.

The intermediate threshold for each type of roundabout (one-lane and two-lane) is based on the most conservative combination of the above factors; the upper threshold is based on the combination to produce the highest AADT

(e.g., K of 0.09, D of 0.52, minor street ratio of 0.50, and volume-to-capacity ratio of 1.00). It is suggested that a reasonable approximation of lane requirements for a three-leg roundabout may be obtained using 75% of the service volumes shown on Exhibit 3-12.

Exhibit 3-12
Planning-Level Daily
Intersection Volumes

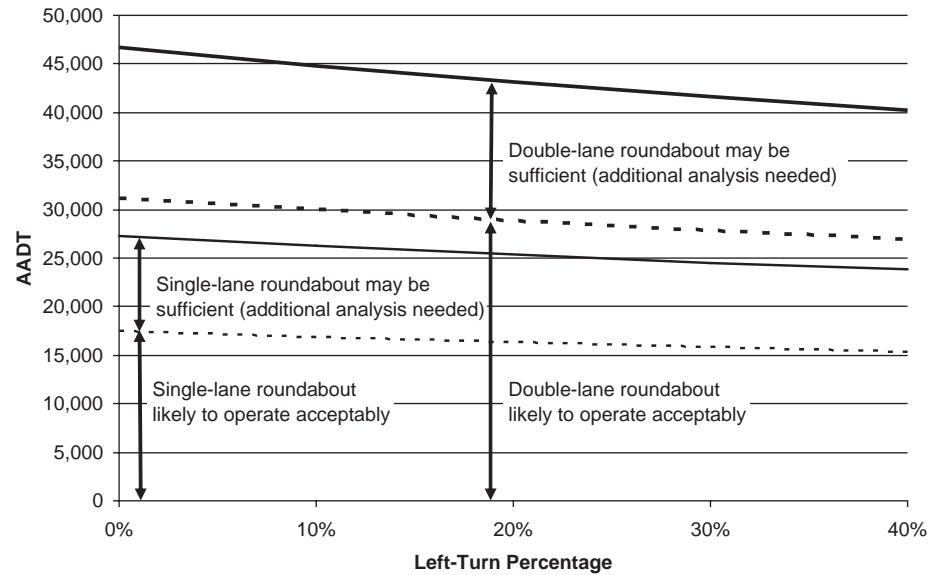

If the volumes fall within the ranges identified in Exhibit 3-12 where “additional analysis is needed,” a single-lane or two-lane roundabout may still function quite well, but a closer look at the actual turning-movement volumes during the design hour is required. The procedure for such analysis is presented in Chapter 4.

Where existing and/or projected turning-movement data is available at the planning level, an improved estimate of the required lane configurations can be identified. Even if future projections of turning movements are not available, estimating future turning movements using existing turning movements and a reasonable annual growth rate may provide a sufficient level of accuracy for this planning exercise. The procedure provided within this section is a simplification of the capacity estimates presented in Chapter 4.

The capacity of a roundabout is generally driven by the amount of conflicting traffic (vehicles traveling along the circulatory roadway) that is present at each roundabout entry. High conflicting volumes reduce the number of opportunities for vehicles to enter the roundabout and therefore reduce the capacity of a particular approach leg. Conversely, where low conflicting traffic volumes are present, the approach leg will have a higher capacity and allow for a higher number of vehicles to enter the roundabout. Each approach leg of the roundabout is evaluated individually to determine the number of entering lanes that are required based upon the conflicting flow rates. The number of lanes within the circulatory roadway is then the number of lanes needed to provide lane continuity

through the intersection. More detailed lane assignments and refinements to the lane configurations can be determined later through a more formal operations analysis.

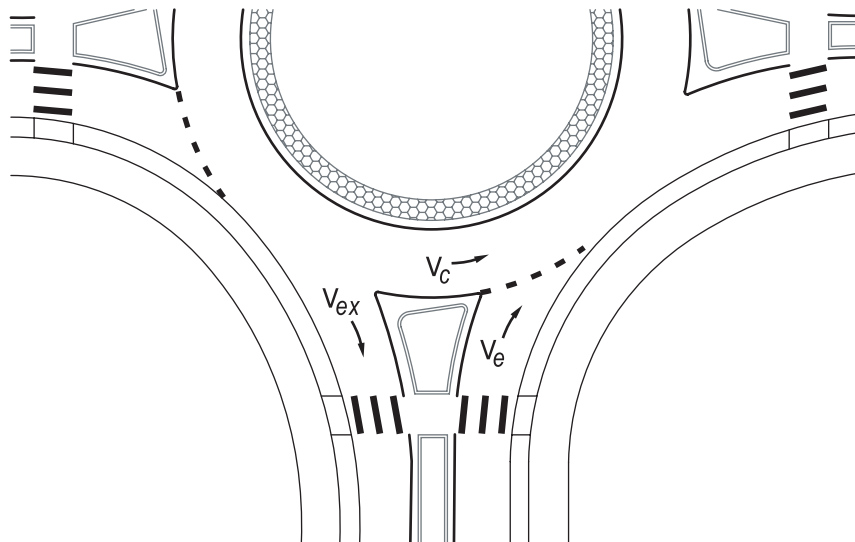

Exhibit 3-13
Traffic Flows at a Roundabout Entry

Rule of Thumb: If the sum of the entering and circulating volumes for each approach is less than 1,000 veh/h, then a single-lane roundabout is likely to operate acceptably.

The sum of the entering (v_e) and conflicting (v_c) traffic volumes, as illustrated in Exhibit 3-13, can be used to evaluate the number of lanes required on the entry (1). If the sum of the entering and conflicting volumes is less than 1,000 vehicles per hour (veh/h), then a single-lane entry can be reasonably assumed to operate within its capacity. Exhibit 3-14 provides additional planning-level lane requirements for various combinations of entering and circulating volumes, and Exhibit 3-15 gives an example of planning-level calculations.

Volume Range (sum of entering and conflicting volumes)	Number of Lanes Required
0 to 1,000 veh/h	<ul style="list-style-type: none"> Single-lane entry likely to be sufficient
1,000 to 1,300 veh/h	<ul style="list-style-type: none"> Two-lane entry may be needed Single-lane may be sufficient based upon more detailed analysis.
1,300 to 1,800 veh/h	<ul style="list-style-type: none"> Two-lane entry likely to be sufficient
Above 1,800 veh/h	<ul style="list-style-type: none"> More than two entering lanes may be required A more detailed capacity evaluation should be conducted to verify lane numbers and arrangements.

Source: New York State Department of Transportation

Exhibit 3-14
Volume Thresholds for Determining the Number of Entry Lanes Required

Exhibit 3-15
 Example Planning-Level
 Exercise for Determining
 Required Numbers of
 Lanes Using Turning-
 Movement Data

Example: Estimating Number of Lanes Using Turning-Movement Volumes

Question
 How many lanes are required to serve these design-year traffic volumes:

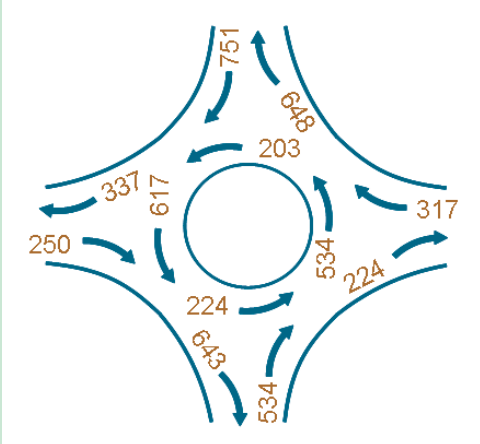

Calculations
 Entering volume + Circulating volume = X Compare to Exhibit 3-14

250 + 617 = 867	<1,000	Single Lane OK
534 + 224 = 758	<1,000	Single Lane OK
317 + 534 = 851	<1,000	Single Lane OK
751 + 203 = 954	<1,000	Single Lane OK

Conclusions
 Using the traffic data identified above and the volume ranges in Exhibit 3-14, a single-lane roundabout would be estimated to adequately handle the design-year traffic volumes for each individual approach. Therefore, a single-lane roundabout could be advanced forward for the rest of the planning-level evaluations, including estimates of the intersection footprint (right-of-way needs) and impacts.

3.5.2 MINI-ROUNDBABOUTS

Mini-roundabouts are distinguished from traditional roundabouts primarily by their smaller size and more compact geometry. They are typically designed for negotiating speeds of 15 mph (25 km/h). Inscribed circle diameters generally vary from 45 to 80 ft (13 to 25 m). For most applications peak-period capacity is seldom an issue, and most mini-roundabouts operate on residential or collector streets at demand levels well below their capacity. It is important, however, to be able to assess the capacity of any proposed intersection design to ensure that the intersection would function properly if constructed.

At very small roundabouts, it is reasonable to assume that each quadrant of the circulatory roadway can accommodate only one vehicle at a time. In other words, a vehicle may not enter the circulatory roadway unless the quadrant on both sides of the approach is empty. Given a set of demand volumes for each of the 12 standard movements at a four-leg roundabout, it is possible to simulate the roundabout to estimate the maximum service volumes and delay for each

approach. By making assumptions about the proportion of left turns and the proportion of cross-street traffic, a general estimate of the total entry maximum service volumes of the roundabout can be made; an example is provided in Exhibit 3-16. AADT maximum service volumes are represented based on an assumed K value of 0.10. Note that these volumes range from slightly more than 12,000 to slightly less than 16,000 vehicles per day. The maximum throughput is achieved with an equal proportion of vehicles on the major and minor roads and with low proportions of left turns.

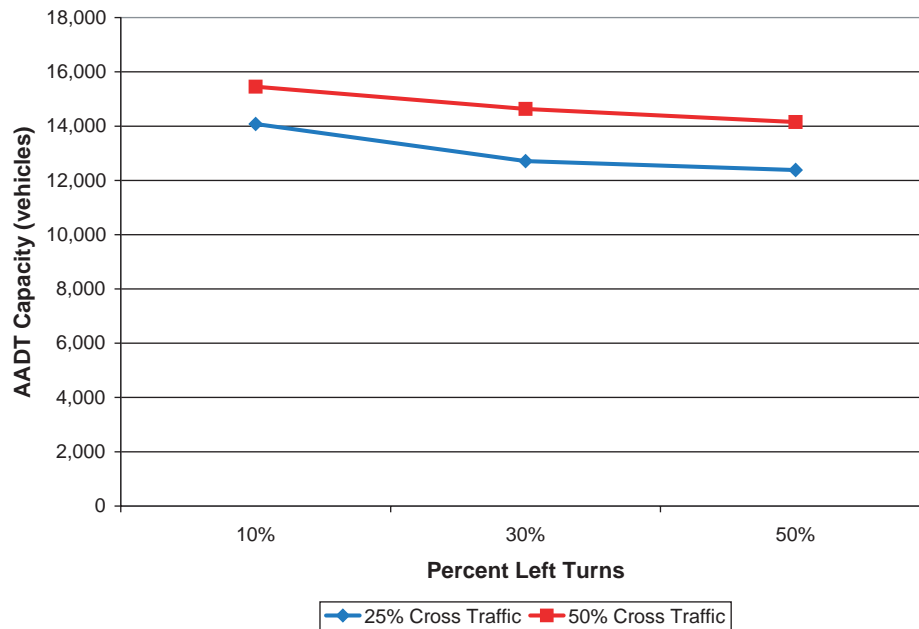

Exhibit 3-16
Planning-Level Maximum
Daily Service Volumes for
Mini-Roundabouts

Because of their mountable nature, mini-roundabouts do not provide the same degree of visibility and channelization provided by larger roundabouts with raised islands. As a result, mini-roundabouts have some notable limitations in application:

- Mini-roundabouts are recommended primarily for areas in which all approaching roadways have an 85th-percentile speed of less than 30 mph (50 km/h) or less. Although some traffic calming may result from their use (and they could be integrated into a broader system of traffic calming measures), the mini-roundabout should be limited to use in lower speed environments.
- Mini-roundabouts are not recommended in locations in which high U-turn traffic is expected, such as at the ends of street segments with access restrictions. However, the mini-roundabout should be designed to accommodate U-turns for passenger cars. Due to radius restrictions of the small inscribed circle diameter, larger vehicles may not be capable of making a U-turn movement.
- Mini-roundabouts are not well suited for high volumes of trucks, as trucks will occupy most of the intersection when turning, significantly

Mini-roundabouts are not recommended where approach speeds are greater than 30 mph (50 km/h), nor in locations with high U-turning volumes.

reducing the capacity of a mini-roundabout. Additionally, high volumes of trucks overrunning the central island may lead to rapid wear of the roadway markings.

3.5.3 SPACE REQUIREMENTS

An initial estimate of the space (footprint) required for a roundabout is a common question at the planning stage and may affect the feasibility of a roundabout at any given location. At this planning level, important questions may begin to be explored including:

- Is sufficient space available to accommodate an appropriately sized roundabout?
- What property impacts might be expected?
- Is additional right-of-way likely to be required?
- Are there physical constraints that may affect the location and design of the roundabout?

Due to the need to accommodate large trucks (such as WB-50 or WB-67 tractor-trailer combinations) through the intersection, roundabouts typically require more space than conventional intersections. However, this may be offset by the space saved compared with turning lane requirements at alternative intersection forms.

The key indicator of the required space is the inscribed circle diameter. A detailed design is required to determine the space requirements at a specific site, especially if more than one lane is needed to accommodate the entering and circulating traffic.

One important question is whether or not the proposed roundabout will fit within the existing property lines or whether additional right-of-way will be required. Exhibit 3-17 and Exhibit 3-18 illustrate that roundabouts typically require more area at the junction than conventional intersections. (Mini-roundabouts are not shown because they are assumed to be located within the footprint of a conventional intersection.) However, as capacity needs increase the size of the roundabout and comparable conventional (signalized) intersection, the increase in space requirements is increasingly offset by a reduction in space requirements on the approaches. This is because the widening or flaring required for a roundabout can be accomplished in a shorter distance than is typically required to develop left-turn lanes and transition tapers at conventional intersections. Intersection skew can also affect the area impacts, and may require approach realignment or a large inscribed circle diameter to obtain appropriate geometry.

Roundabouts often offer the potential for reducing special requirements on approaches compared to conventional intersections. This effect of providing capacity at the intersections while reducing lane requirements between intersections, known as the wide nodes, narrow roads concept, is discussed further in Chapter 2.

Although roundabouts typically require more area at the junction compared to conventional intersections, they may not need as much area on the approaches.

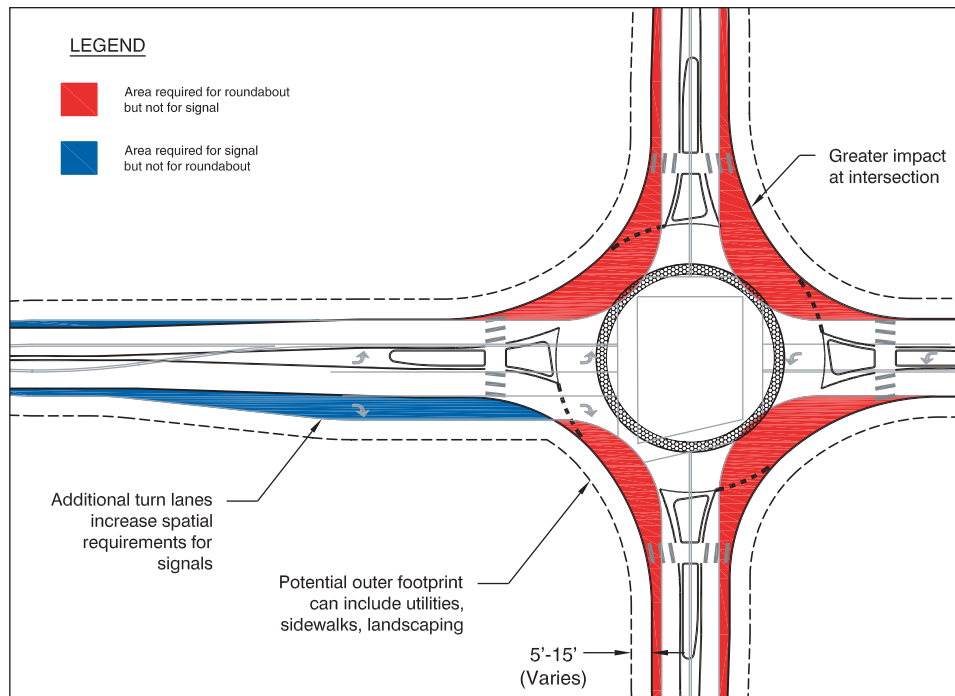

Exhibit 3-17
Area Comparison: Single-Lane Roundabout versus Comparable Signalized Intersection

3.5.4 DESIGN CONSIDERATIONS

Designing roundabouts involves trade-offs among safety, capacity, impacts, costs, and other factors. While a much more detailed discussion regarding roundabout geometric design is provided in Chapter 6, fundamental design considerations should be evaluated early on at a planning level to produce a better understanding of the size and potential impacts for the roundabout alternative. In the end, designing a roundabout involves determining the optimal balance between safety, operational performance, and accommodating appropriate design vehicles given the specific parameters and constraints for the site under evaluation.

3.5.4.1 Design Vehicle

The choice of design vehicle will vary depending upon the approaching roadway types and the surrounding land use characteristics. The local or state agency with jurisdiction of the associated roadways should usually be consulted to identify the design vehicle at each site. Appropriate design vehicle consideration will depend on road classification, input from jurisdictions and/or road authorities, and the surrounding environment. On larger statewide facilities, such as interstate freeway ramps or intersections with state highway facilities, it may be necessary to accommodate large WB-67 trucks or even oversized vehicles (superloads). Smaller design vehicles may often be chosen at local street intersections. The size of the design vehicle often has a direct effect on the size of the inscribed circle diameter required.

In general, larger roundabouts are often used to accommodate large vehicles while maintaining low speeds for passenger vehicles. In some cases, land

Roundabouts: An Informational Guide

Exhibit 3-18
Area Comparison: Multilane
Roundabout versus Compara-
ble Signalized Intersection

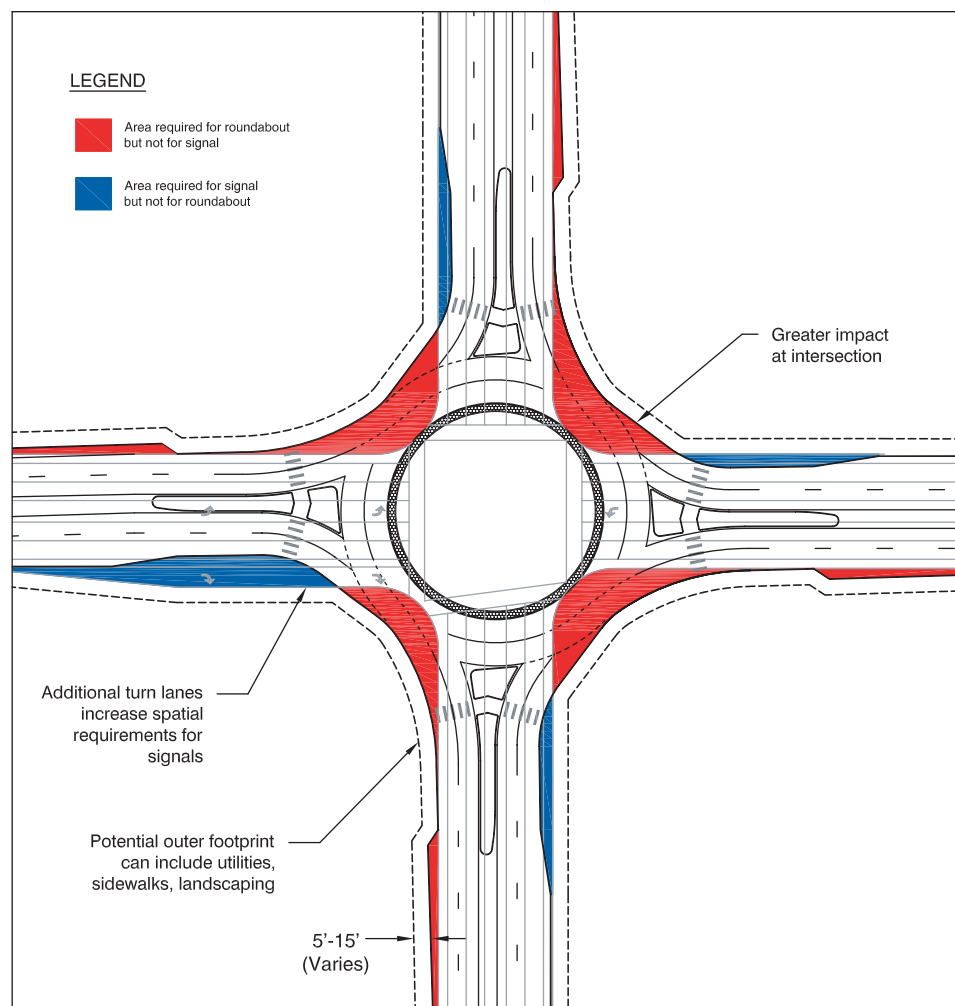

constraints also dictate the need for approach re-alignment to adequately accommodate large semi-trailer combinations while achieving appropriate deflection for small vehicles. In particular, at locations where a WB-67 is anticipated to be the design vehicle, a larger inscribed circle diameter should be planned for when estimating the space requirements of the roundabout.

Design vehicles alone should not dictate roundabout designs or specific dimensions. It is often beneficial to engage local stakeholders to ensure that the proper design is developed. In the case of larger vehicles, it may be appropriate to choose another route entirely, negating the need to design the roundabout to accommodate these vehicles. In rural locations, a farm vehicle may be the most appropriate design vehicle and require special attention.

3.5.4.2 Speeds and Path Alignment

Achieving appropriate vehicular speeds through the roundabout is a critical design objective that may affect safety. A well-designed roundabout reduces the relative speeds between conflicting traffic streams by requiring vehicles to negotiate the roundabout along a curved path. Any conceptual design(s) prepared at the

planning level should depict reasonable entry deflection for speed control. Detailed procedures for evaluating the fastest path speeds through a roundabout are provided in Chapter 6 and may be used to verify reasonableness.

In addition to evaluating vehicle speeds, the design of a multilane roundabout should naturally align entering lanes into their appropriate lane within the circulatory roadway and then to the appropriate lanes on the exit. If the alignment of one lane interferes or overlaps with that of an adjacent lane, the roundabout may not operate as safely or efficiently as possible. At the planning level, any conceptual designs prepared should be visually evaluated for reasonable alignment of the entry lanes to the corresponding lanes within the circulatory roadway.

Designing to achieve both speed reductions and adequate path alignment may require offsetting of the approach alignment to the left of the existing roadway centerlines or other techniques that could affect the space required for the roundabout. As such, when evaluating the space availability for a roundabout, constraints along the approach roadways should also be identified.

3.5.4.3 Pedestrians

In urban and suburban areas where pedestrians are expected, important design considerations include:

- Minimizing the number of travel lanes to improve the simplicity and safety of roundabouts for pedestrians,
- Designing for slow vehicle speeds,
- Providing sidewalks that are set back from the circulatory roadway,
- Providing well-defined and well-located crosswalks, and
- Providing splitter islands with at least a width of 6 ft (1.8 m) at the crosswalks.

Chapter 6 includes detailed information on providing these design considerations.

3.5.4.4 Bicyclists

Safety and usability of roundabouts for bicyclists depends on the details of the roundabout design and special provisions for bicyclists. Since typical on-road bicyclist travel speeds are 12 to 20 mph (19 to 32 km/h), roundabouts that are designed to constrain the speeds of motor vehicles to similar values will minimize the relative speeds between bicyclists and motorists and thereby improve safety and usability for cyclists.

Single-lane roundabouts are much simpler for cyclists than multilane roundabouts since they do not require cyclists to change lanes to make left-turn movements or otherwise select the appropriate lane for their direction of travel. Cyclists who have the knowledge and skills to ride effectively and safely on roadways can navigate low-speed single lane roundabouts without much difficulty. The primary design consideration for single-lane roundabouts is to terminate bicycle lanes prior to roundabouts and not include bicycle lanes on circulatory roadways.

At multilane roundabouts and other roundabouts where typical on-road cyclists may not feel comfortable traversing some roundabouts in the same manner as other vehicles, bicycle ramps can be provided to allow access to the sidewalk or a shared-use path at the roundabout. More details about terminating bicycle lanes and providing bicycle ramps at roundabouts can be found in Chapter 6.

3.6 COMPARING PERFORMANCE OF ALTERNATIVE INTERSECTION TYPES

A roundabout is often compared to other intersection types, usually either a stop- or signal-controlled intersection. Chapter 4 provides operational performance evaluation models that may serve as a sound basis for comparison, but their application may require more effort and resources than an agency is prepared to devote in the planning stage. Similarly, Chapter 5 provides more detailed safety evaluation procedures, but those can require more data and effort than necessary for establishing roundabout feasibility.

To simplify the planning process, the following generalized information is offered for a planning-level operational comparison of control modes:

- A roundabout will always provide a higher capacity and lower delays than all-way stop-control (AWSC) operating with the same traffic volumes.
- A roundabout is unlikely to offer better performance in terms of lower overall delays than TWSC at intersections with minor movements (including cross-street entry and major-street left turns) that are not experiencing, nor predicted to experience, operational problems under TWSC.
- A single-lane roundabout may be assumed to operate within its capacity at any intersection that does not exceed the peak-hour volume warrant for signals.
- A roundabout that operates within its capacity will generally produce lower delays than a signalized intersection operating with the same traffic volumes.

Roundabouts offer significant benefits for improving safety and may easily be justified solely on the basis of crash reductions, particularly for reducing serious injury and fatal crashes. Recent research of roundabouts in the United States identified crash reductions of approximately 35.4% for all crashes and 75.8% for injury crashes when an intersection was converted from a signal or stop control to a roundabout (2). Single-lane roundabouts generally offer greater safety benefits than multilane roundabouts due to fewer points of conflict. The decision to install a roundabout as a safety improvement should be based on a demonstrated safety problem of the type susceptible to correction by a roundabout. A review of crash reports and the type of crashes occurring is essential.

Examples of safety problems that are potentially correctable by roundabouts include:

- High rates of crashes involving right angle, head-on, left/through, and U-turn conflicts;
- High crash severity (injury or fatality crashes);
- Sight distance or visibility problems that reduce the effectiveness of stop sign control (in this case, landscaping of the roundabout needs to be carefully considered); and
- Inadequate separation of movements, especially on single-lane approaches.

The remainder of this section provides additional planning-level guidance on operational and safety comparisons to other intersection control alternatives, including TWSC, AWSC, and signal control.

3.6.1 TWO-WAY STOP-CONTROL ALTERNATIVE

The majority of intersections in the United States operate under TWSC, and most of these intersections operate with minimal delay. A roundabout is unlikely to offer better performance in terms of lower overall delays than TWSC at intersections with minor movements (including cross-street entry and major-street left turns) that are not experiencing, nor predicted to experience, operational problems under TWSC. Therefore, the installation of a roundabout at a TWSC intersection that is operating satisfactorily will be difficult to justify on the basis of operational performance improvement alone.

From a safety perspective, roundabouts offer significant benefits over TWSC intersections. Research of U.S. roundabouts has identified that average reductions of 44.2% for all crashes and 81.8% for injury crashes have been observed when converting TWSC intersections to roundabouts (2). Injury reductions were found to range between 68% and 87%, depending on the setting (urban, rural, suburban) and whether the roundabout was single-lane or multilane. Higher crash reductions were observed in rural settings, where total crash reductions were found to be 71.5% and injury crashes were reduced by 87.3%.

The two most common operational problems at TWSC intersections are congestion on the minor street caused by a demand that exceeds capacity, and queues that form on the major street because of inadequate capacity for left-turning vehicles yielding to opposing traffic. Roundabouts may offer an effective solution to traffic problems at TWSC intersections with heavy left turns from the major route because they provide more favorable treatment to left turns than other control modes. T-intersections are especially good candidates in this category because they tend to have higher left turning volumes.

On the other hand, the problems experienced by low-volume cross-street traffic at TWSC intersections with heavy through volumes on the major street are very difficult to solve by any traffic control measure. A roundabout may be a reasonable alternative even under situations where the minor street volume is low. However, when evaluating locations where the proportion of traffic on the major street is high, it is important to consider the context of the location when evaluating the control alternatives.

Roundabouts offer significant safety benefits over TWSC intersections.

Roundabouts may offer an effective solution at TWSC intersections with heavy left turns from the major street.

Roundabouts will always offer better operational performance for vehicles than AWSC.

A substantial part of the delay-reduction benefit of roundabouts, compared to AWSC intersections, comes during off-peak periods.

3.6.2 ALL-WAY STOP-CONTROL ALTERNATIVE

When cross-street traffic volumes are heavy enough to meet the *Manual of Uniform Traffic Control Devices* (MUTCD) (3) warrants for AWSC, roundabouts become an especially attractive solution because of their higher capacities and lower delays. Roundabouts can be expected to always offer better operational performance for vehicles than AWSC, given the same traffic conditions. Roundabouts that are proposed as alternatives to stop control would typically have single-lane approaches.

A substantial part of the operational benefit of a roundabout compared to an all-way stop intersection is obtained during the off-peak periods because the restrictive stop control applies for the entire day. The MUTCD does not permit stop control on a part-time basis. The extent of the benefit will depend on the amount of traffic at the intersection and on the proportion of left turns. Left turns degrade the operation of all traffic control modes, but they have a smaller effect on roundabouts than stop signs or signals.

From a safety perspective, U.S. research has identified that the conversion of an AWSC intersection to a roundabout results in an insignificant difference in safety performance, primarily due to the low volume conditions where an AWSC would be appropriate. Therefore, when comparing a roundabout to an AWSC alternative, the primary considerations should be operations and cost. Roundabouts may also offer other benefits to AWSC intersections, including use as a gateway treatment or for community enhancement.

3.6.3 SIGNAL CONTROL ALTERNATIVE

When traffic volumes are heavy enough to warrant signalization, the selection process becomes somewhat more rigorous. The usual basis for selection is that a roundabout will provide better operational performance than a signal in terms of stops, delay, vehicle queues, fuel consumption, safety, and pollution emissions. For planning purposes, this may be assumed to be the case provided that the roundabout is operating within its capacity. A roundabout that operates within its capacity will generally produce lower delays than a signalized intersection operating with the same traffic volumes and right-of-way limitations. The task then becomes to assess whether any roundabout configuration can be made to work satisfactorily. If not, a signalized intersection and a grade separation are commonly the remaining alternatives.

As in the case of stop control, intersections with heavy left turns are especially good roundabout candidates. Intersections with limited queue storage for major street left turns or minor street movements may also make a good candidate for a roundabout. Roundabouts are also an effective alternative to signalized control for closely spaced intersections since signal control can be difficult to manage vehicle queues between intersections.

Unlike traffic signal control, there are no warrants for roundabouts currently included in the MUTCD. Each roundabout must be justified on its own merits as the most appropriate intersection treatment alternative. It is, however, useful to consider the case in which the traffic volumes just meet the MUTCD warrant thresholds for traffic signals. At these volume levels a single-lane roundabout is

anticipated to operate within its capacity and can be used to make some planning-level comparisons of roundabout delay to signal delay. Exhibit 3-19 presents average delays per vehicle for signals and roundabouts. These values represent the approach delay as perceived by the motorist. They do not include the geometric delay incurred within the roundabout. It is clear from this figure that roundabout control delays are substantially lower than signal delays, but in neither case are the delays excessive.

Roundabouts offer significant safety benefits in comparison to signalized intersections. Roundabouts provide an overall reduction in vehicle speed, eliminate dangerous situations, such as red-light running, and remove some of the most serious conflict points including angle, left-turn, and head-on crashes. This results in observed safety benefits at U.S. roundabouts of 77.7% for injury crashes and 47.8% for all crash types and severities (2).

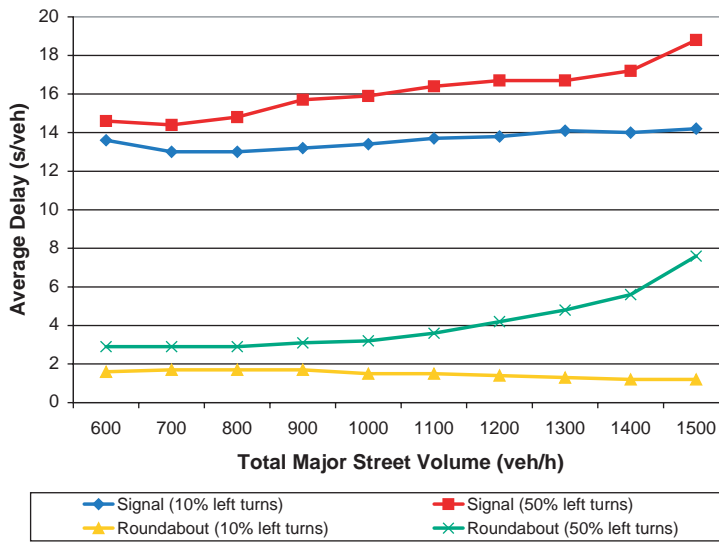

Exhibit 3-19
Average Control Delay per Vehicle at the MUTCD Peak-Hour Signal Warrant Thresholds

3.7 ECONOMIC EVALUATION

Many factors influence the amount of economic investment justified for any type of intersection. Costs associated with roundabouts include construction costs, engineering and design fees, land acquisition, and maintenance costs. Benefits may include reduced crash rates and severity, as well as reduced delay, stops, fuel consumption, and emissions.

When comparing costs, it is often difficult to separate the actual intersection costs from an overall improvement project. Accordingly, the reported costs of installing roundabouts have been shown to vary significantly from site to site. A roundabout may cost more or less than a traffic signal, depending on the amount of new pavement area and the extent of other roadway work required. At some existing unsignalized intersections, a traffic signal can be installed without significant modifications to the pavement area or curbs. In these instances, a roundabout

Roundabouts may require more pavement area at the intersection compared to a traffic signal, but less on the approaches and exits.

The cost of maintaining traffic during construction of a roundabout retrofit can be relatively high.

is likely to be more costly to install than a traffic signal since the roundabout can rarely be constructed without significant pavement and curb modifications.

However, at new sites and at signalized intersections that require widening on one or more approaches to provide additional turn lanes, a roundabout can be a comparable or less-expensive alternative. While roundabouts typically require more pavement area at the intersection, they may require less pavement width on the upstream approaches and downstream exits if multiple turn lanes associated with a signalized intersection can be avoided. The cost savings of reduced approach roadway widths is particularly advantageous at interchange ramp terminals and other intersections adjacent to grade separations where wider roads may result in larger bridge structures. In most cases, except potentially for a mini-roundabout, a roundabout is more expensive to construct than the two-way or all-way stop-controlled intersection alternatives.

Higher costs are typically incurred when a substantial amount of realignment, grading, or drainage work is required. The cost of maintaining traffic during construction tends to be relatively high for retrofitting roundabouts. This expense is due mainly to the measures required to maintain existing traffic flow through the intersection while rebuilding it in stages. Other factors contributing to high roundabout costs are large amounts of landscaping in the central and splitter islands, extensive signing and lighting, and the provision of curbs on all outside pavement edges.

Operating and maintenance costs of roundabouts are somewhat higher than for other unsignalized intersections but less than signalized intersections. In addition, traffic signals consume electricity and require periodic service (e.g., bulb replacement, detector replacement, and periodic signal re-timing). For these reasons, operating costs over a design life of 20 years or longer should be considered when comparing between intersection treatments. Operating costs for a roundabout are generally limited to the cost of illumination (similar to signalized alternatives but typically more than is required for other unsignalized intersections). Maintenance includes regular re-striping and re-paving as necessary, as well as snow removal and storage in cold climates (these costs are also incurred by conventional intersections). Landscaping may require regular maintenance as well, including such things as pruning, mowing, and irrigation system maintenance. To the extent that roundabouts reduce crashes compared with conventional intersections, they will reduce the number and severity of incidents that disrupt traffic flow and may require emergency service.

The most appropriate method for evaluating public works projects of this type is usually the benefit–cost analysis method. The following sections discuss this method as it typically applies to roundabout evaluation, although it can be generalized for most transportation projects.

3.7.1 METHODOLOGY

The benefit–cost method is explained in detail in a number of standard references, including the *Transportation Planning Handbook* (4) and various AASHO and AASHTO publications (5–6). The basic premise of this method of evaluation is to compare the incremental benefit between two alternatives to the incremental costs

between the same alternatives. Assuming Alternatives A and B, the equation for calculating the incremental benefit–cost ratio of Alternative B relative to Alternative A is given in Equation 3-1.

$$B/C_{B \rightarrow A} = \frac{\text{Benefits}_B - \text{Benefits}_A}{\text{Costs}_B - \text{Costs}_A}$$

Equation 3-1

Benefit–cost analysis typically takes two forms. For assessing the viability of a number of alternatives, each alternative is compared individually with a no-build alternative. If the analysis for Alternative A relative to the no-build alternative indicates a benefit–cost ratio exceeding 1.0, Alternative A has benefits that exceed its costs and is thus a viable project.

For ranking alternatives, the incremental benefit–cost ratio analysis is used to compare the relative benefits and costs between alternatives. Projects should not be ranked based on their benefit–cost ratio relative to the no-build alternative. After eliminating any alternatives that are not viable as compared to the no-build alternative, alternatives are compared in a pair-wise fashion to establish the priority between projects.

Since many of the input parameters may be estimated, a rigorous analysis should be considered of varying the parameter values of key assumptions to verify that the recommended alternative is robust, even under slightly varying assumptions, and under what circumstances it may no longer be preferred.

3.7.2 ESTIMATING BENEFITS

Benefits for a public works project are generally composed of three elements: safety benefits, operational benefits, and environmental benefits. Each benefit is typically quantified on an annualized basis and so is readily usable in a benefit–cost analysis. The following sections discuss these in more detail.

Rank alternatives based on their incremental benefit–cost ratio, not on their ratio relative to the no-build alternative.

Projects may realize safety, operational, and environmental benefits.

3.7.2.1 Safety Benefits

Safety benefits are defined as the assumed savings to the public due to a reduction in crashes within the project area. The procedure for determining safety benefits is as below. (Detail on the methodology can be found in Chapter 5.):

1. Quantify the existing safety history in the study area in terms of a crash rate for each level of severity (fatal, injury, property damage). This rate, expressed in terms of crashes per million entering vehicles, is computed by dividing the number of crashes of a given severity that occurred during the before period by the number of vehicles that entered the intersection during the same period. This results in a before crash rate for each level of severity.
2. Estimate the change in crashes of each level of severity that can be reasonably expected due to the proposed improvements. As documented elsewhere in this guide, roundabouts tend to have proportionately greater reductions in fatal and injury crashes than property damage crashes.
3. Determine a new expected crash rate (an after crash rate) by using the procedures presented in Chapter 5. It is best to use local data to determine

appropriate crash reduction factors due to geometric or traffic control changes, as well as the assumed costs of various severity levels of crashes.

4. Estimate the number of after crashes of each level of severity for the life of the project by multiplying the after crash rate by the expected number of entering vehicles over the life of the project.
5. Estimate a safety benefit by multiplying the expected number of after crashes of each level of severity by the average cost of each crash and then annualizing the result. The values in Exhibit 3-20 can provide a starting point, although local data should be used where available.

Exhibit 3-20
Estimated Costs for Crashes
of Varying Levels of Severity

Crash Severity	Economic Cost per Crash (2008 dollars)
Fatality	\$4,200,000
Class A (incapacitating injury)	\$214,200
Class B (non-incapacitating evident injury)	\$54,700
Class C (possible injury)	\$26,000
Property Damage Only (per crash)	\$2,400

Source: National Safety Council (7)

Quantify operational benefits in terms of vehicle-hours of delay.

3.7.2.2 Operational Benefits

The operational benefits of a project may be quantified in terms of the overall reduction in person-hours of delay to the public. Delay has a cost to the public in terms of lost productivity, and thus a value of time can typically be assigned to changes in estimated delay to quantify benefits associated with delay reduction.

The calculation of annual person-hours of delay can be performed with varying levels of detail, depending on the availability of data. For example, one method for computing the vehicle-hours of delay is as follows.

1. Estimate the delay per vehicle for each hour of the day. If turning movements are available for multiple hours, this estimate can be computed directly. If only the peak hour is available, the delay for an off-peak hour can be approximated by proportioning the peak-hour turning movements by total entering vehicles.
2. Determine the daily vehicle-hours of delay by multiplying the estimated delay per vehicle for a given hour by the total entering vehicles during that hour, and then aggregate the results over the entire day. If data is available, these calculations can be separated by day of week or by week-day, Saturday, and Sunday. In some cases it may be appropriate to assume that the daily vehicle-hours of delay are equal to a factor, say 10, times the delay during the peak hour.
3. Determine annual vehicle-hours of delay by multiplying the daily vehicle-hours of delay by 365. If separate values have been calculated by day of

week, first determine the weekday vehicle-hours of delay and then multiply by 52.1 (365 divided by 7). It may be appropriate to use fewer than 365 days per year because the operational benefits will not usually apply equally on all days. For example, to provide a conservative estimate of benefits, a value of 250 days per year could be used.

4. Convert the results to person-hours of delay using appropriate vehicle-occupancy factors (including transit), then add pedestrian delay if significant.

3.7.2.3 Environmental Benefits

The environmental benefits of a project are most readily quantified in terms of reduced fuel consumption and improved air quality. Of these, reductions in fuel consumption and the benefits associated with those reductions are typically the simplest to determine.

One way to determine fuel consumption is to use the same procedure for estimating delay as described previously. Fuel consumption is an output of several of the models in use today, although the user is cautioned to ensure that the model is appropriately calibrated for current U.S. conditions. Alternatively, one can estimate fuel consumption by using the estimate of annual vehicle-hours of delay and then multiplying that by an assumed fuel consumption rate during idling, expressed as gallons per hour (liters per hour) of idling. The resulting estimate can then be converted to a cost by assuming an average cost of fuel, expressed in dollars per gallon (dollars per liter).

3.7.3 ESTIMATION OF COSTS

Costs for a public works project are generally composed of two elements: capitalized construction costs (including right-of-way) and operations and maintenance (O&M) costs. Although O&M costs are typically determined on an annualized basis, construction costs are typically a near-term activity that must be annualized. The following sections discuss these in more detail.

3.7.3.1 Construction Costs

Construction costs for each alternative should be calculated using normal preliminary engineering cost-estimating techniques. These costs should include the costs of any necessary earthwork, paving, bridges and retaining walls, signing and striping, illumination, and signalization.

To convert construction costs into an annualized value for use in the benefit–cost analysis, a *capital recovery factor* (CRF) should be used, shown in Equation 3-2. This converts a present-value cost into an annualized cost over a period of n years using an assumed discount rate of i percent.

$$CRF = \frac{i(1+i)^n}{(1+i)^n - 1}$$

Equation 3-2

where

i = discount rate

n = number of periods (years)

Roundabout O&M costs are typically slightly higher than signalized intersections for illumination, signing, pavement marking, and landscaping.

Signalized intersections also have O&M costs for signal power, bulb replacement, and detection maintenance.

Surveys find negative public attitudes toward roundabouts before construction, but positive attitudes following construction.

Public meetings, videos and brochures, and media announcements are some of the ways to educate the public about new roundabouts.

3.7.3.2 Operation and Maintenance Costs

Operation and maintenance (O&M) costs vary significantly between roundabouts and other forms of intersection control beyond the basic elements. Common elements include signing and pavement marking maintenance and power for illumination, if provided.

Roundabouts typically have slightly higher illumination power and maintenance costs compared to signalized or sign-controlled intersections due to a larger number of illumination poles. Roundabouts have slightly higher signing and pavement marking maintenance costs due to a higher number of signs and pavement markings. Roundabouts also introduce additional cost associated with the maintenance of any landscaping in and around the roundabout.

Signalized intersections have considerable additional cost associated with power for the traffic signal and maintenance costs such as bulb replacement and detection maintenance. Power costs vary considerably from region to region and over time and should be verified locally. For general purposes, an annual cost of \$3,000 for providing power to a signalized intersection is a reasonable approximation. In addition, for optimal operation the signal timing for the intersection needs to be maintained. Signal timing maintenance requires a specialized workforce and equipment (including periodic collection of traffic count data), and often traffic signals are added to an agency's responsibility without a commensurate increase in budget and workforce to accommodate this additional maintenance. Signal retiming has been documented to cost approximately \$2,500 to \$3,100 per signal and needs to be repeated every few years (8–9).

3.8 PUBLIC INVOLVEMENT

Public acceptance of roundabouts has often been found to be one of the biggest challenges facing a jurisdiction that is planning to install its first roundabout. Without the benefit of explanation or first-hand experience and observation, the public is likely to incorrectly associate roundabouts with older, non-conforming traffic circles that they have either experienced or heard about. Equally likely, without adequate education, the public (and agencies alike) will often have a natural hesitation or resistance against changes in their driving behavior and driving environment.

In such a situation, a proposal to install a roundabout may initially experience a negative public reaction. However, the history of roundabouts installed in the United States also indicates that public attitude toward roundabouts improves significantly after construction. Surveys conducted by the Insurance Institute for Highway Safety (IIHS) reported a significant negative public attitude toward roundabouts prior to construction (41% of the responses were strongly opposed) but a positive attitude after construction (63% of the responses were positive or very positive) (10).

A wide variety of techniques have been used successfully in the United States to inform and educate the public about new roundabouts. Some of these include

public meetings, informational brochures and videos, and announcements in the newspaper or on television and radio. A public involvement process should be initiated as soon as practical, preferably early in the planning stages of a project while other intersection forms are also being considered.

3.8.1 AUDIENCE

The type of information presented and the way in which it is communicated is often dependent on the type of audience. Stakeholder audiences may include representatives from the police and fire departments, school district officials, transit operators, developers, business owners, and the freight industry. Audiences may also include public citizens such as nearby residents, seniors, teens, pedestrians with disabilities, and other representatives from the community. Identifying the target audience is one of the initial steps in developing a public involvement program. A roundabout may affect various stakeholders in different ways; therefore, all concerns or questions should be addressed. For example, representatives from the police and fire department are likely focused on ensuring that their emergency vehicles can navigate the intersection and that the roundabout does not significantly affect their response times. Parents in the community may be concerned about how their teen drivers will understand and make decisions as new drivers, or how comfortable they will be walking through the roundabout with their children. In some cases, it may be necessary to hold separate public involvement meetings for different audiences. Technical explanations of the design and operations may be appropriate for certain stakeholders, while more general educational discussions may be held with a group of citizens. The level of effort can vary considerably depending on whether this is the first roundabout in an area or if the local community has had a poor recent experience with roundabouts.

3.8.2 CONTENT

The content that is presented to the public should be appropriate for the type of audience that is being targeted. For all audiences, the purpose of the information being presented or purpose of the meeting should be clearly communicated. In addition, introductory information about roundabouts should be presented, which may include highlighting the differences between roundabouts and other types of intersections, providing guidance on how to drive through a roundabout, and describing the overall advantages and disadvantages of roundabouts. For some public involvement purposes, that introductory material may be the scope of information presented. However, in other cases, more specific project information, stakeholder impacts, and specific community concerns and needs may be addressed.

Public involvement information may be presented in many different ways with a variety of tools. Public meetings are often an effective way to communicate information and gather input from a specific group of individuals. In other cases, a general announcement such as a newspaper article, website, or other media venue may be used to inform a larger group of individuals. Specific tools used for each type of venue are described in the following sections.

3.8.3 PUBLIC MEETINGS

Public meetings can be a useful forum for informing the public about roundabouts in their community and bringing the public into the design process. Engaging

 Roundabouts: An Informational Guide

the public in the design process allows early identification of potential problems and helps to gain overall acceptance throughout the process. Public input may be useful at various stages in the planning process: data collection, problem definition, generation of design alternatives, selection of preferred alternative, detailed design, go/no-go decision, construction/opening, and landscape maintenance. Many jurisdictions require or recommend public meetings with the affected neighborhood or businesses prior to approval of the project by elected officials. Even if such meetings are not required, they can be helpful in easing concerns about a new form of intersection for a community. Tools used in this type of public meeting may include project posters, aerial maps, and visually displayed project information. Exhibit 3-21 provides an example of a poster developed for a roundabout project. This poster highlights the project, stakeholder involvement, and the public information venues that were used throughout the project. Note that the sequence of conversations in this example aims at building consensus at key areas within a community (executive city staff, city council and county commission, and key community organizations) to help with approaching the community at large.

Exhibit 3-21
Example of Public
Information Poster

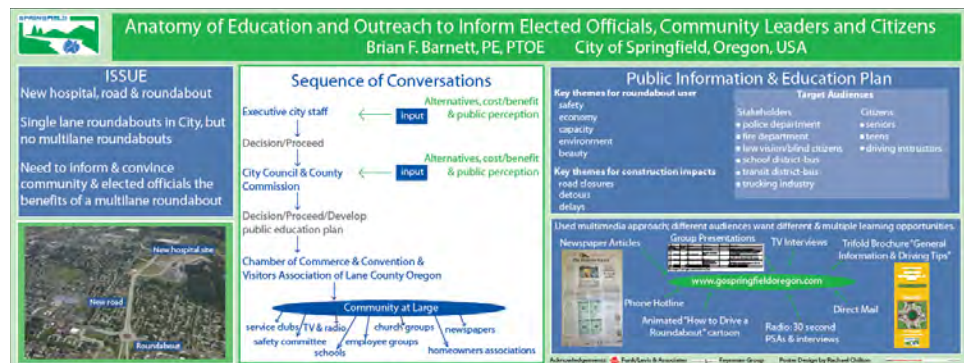

Source: City of Springfield, Oregon (11)

Other public meetings may be designed to teach the public about using roundabouts. For these types of meetings, it is often effective to bring large-scale roundabout models or simulation tools. Exhibit 3-22 illustrates roundabout models that were developed by the Missouri Department of Transportation and the city of Overland Park, Kansas. The latter model was specifically designed to teach school-age children how to safely navigate a roundabout.

3.8.4 INFORMATIONAL BROCHURES

Many agencies have used informational brochures to educate the public about roundabouts in their communities. Brochures have also been prepared for specific projects. Exhibit 3-23 shows examples from brochures prepared for specific projects. These brochures include drawings or photographic simulations of the proposed roundabout. The brochures also typically include general information on roundabouts (what roundabouts are, where they can be found, and the types of benefits that can be expected). Sometimes they also include instructions on how to use the roundabout as a motorist, bicyclist, and pedestrian.



(a) Missouri Department of Transportation



(b) City of Overland Park, Kansas

Exhibit 3-22

Examples of Scale Roundabout Models for Public Involvement

Exhibit 3-24 provides an example of general roundabout brochures that are commonly developed for many cities, counties, and states. These commonly provide detailed guidance for driving through roundabouts and clear illustrations of the signing and striping that drivers may expect to see at a roundabout.

3.8.5 WEBSITES

Websites are an effective tool for educating the public about roundabouts in a specific area and directing the public to other informational websites about roundabouts. Agencies such as the Maryland State Highway Administration (12) and city of Sammamish, Washington (13), have developed roundabout demonstrations on their websites to teach motorists about using a roundabout. These demonstrations include a simulation tool that shows vehicles navigating through the intersection, as shown in Exhibit 3-25. In addition to the simulation tool, the website provides additional Web links and resources for the public to learn about more detailed information or even read about roundabouts in other parts of the county.

Roundabouts: An Informational Guide

Exhibit 3-23
Examples of Project-Specific
Informational Brochures



(a) Town of Vail, Colorado



(b) City of Springfield, Oregon

Exhibit 3-24
Example of General
Informational Brochure



Minnesota Department of Transportation

Exhibit 3-25
Examples of Roundabout
Websites

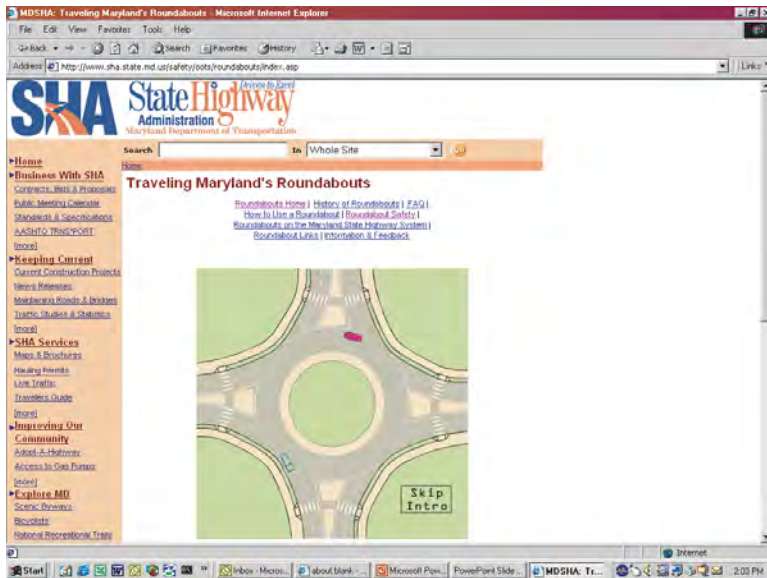

(a) Maryland State Highway Administration

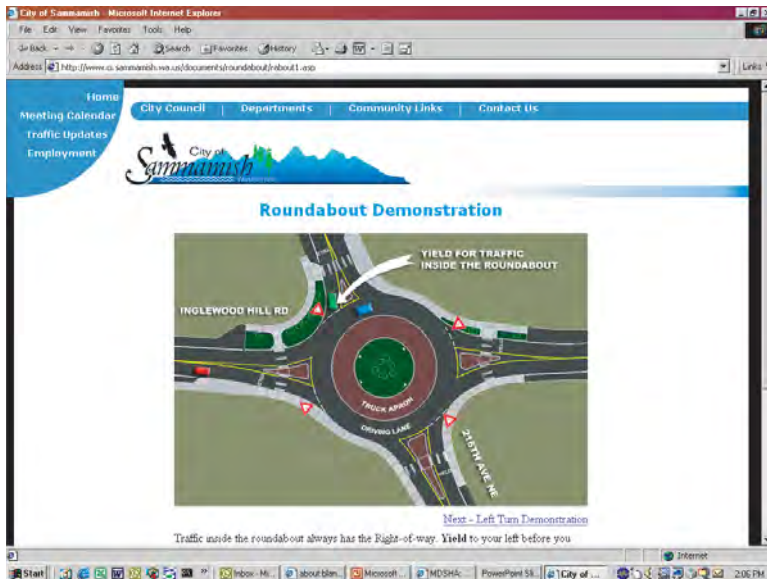

(b) City of Sammamish, Washington

3.8.6 INFORMATIONAL VIDEOS

A number of agencies and consulting firms have prepared videos to inform the public about roundabouts. These videos are typically 10 to 15 minutes in length and include footage of existing roundabouts and narration about their operational and safety characteristics. These videos have been successfully used at public meetings as an effective means of introducing the public to roundabouts. Examples of these informational videos can be found at the city of Modesto, California (14), Washington State Department of Transportation (15), and other state, city, or county websites. Once developed, videos can also

be shown at regular intervals on city or county government access television channels.

3.8.7 MEDIA ANNOUNCEMENTS

Given the new nature of a roundabout in many communities, the local media (newspaper, radio, and television) is likely to become involved. Such interest often occurs early in the process and then again upon the opening of the roundabout. Radio reading services, telephone information services, and publications intended primarily for individuals with disabilities should be used to communicate with persons who are visually impaired when a roundabout is proposed and when it opens.

3.8.8 USER EDUCATION

One of the important issues facing a state considering the implementation of roundabouts is the need to provide adequate driver, cyclist, and pedestrian education. To clarify the following tips and instructions, user education should begin by using simple exhibits such as Exhibit 1-1 from Chapter 1 to familiarize them with the basic physical features of a roundabout intersection. Users should also familiarize themselves with the instructions for all other modes so that they understand the expectations of each other.

Many states in the United States have begun to implement roundabout driving instructions in the state driving manuals. This typically includes a brief introduction to roundabouts and detailed instructions for how to navigate and drive safely through this type of intersection. While states have made tremendous progress with implementing instructions for roundabouts into their driver's manuals, many states do not provide sufficient information for teaching a driver about using turn signals and making decisions with pedestrians, bicycles, and emergency vehicles. The Kansas Driver's Manual, however, does provide detailed steps of navigating a roundabout and considering all users and vehicle types.

States may also consider implementing roundabout education programs within their community to educate all users of all ages about how to safely travel through a roundabout. The Virginia Department of Transportation (VDOT) has developed a website dedicated to educating users about roundabouts in Virginia. This information provides an overview of facts about roundabouts, step-by-step guidelines for using a roundabout, and information about considering pedestrians and older drivers at roundabouts. In addition, VDOT provides announcements of upcoming roundabout presentations and information about their state-wide policy on roundabouts (16).

The city of Bend, Oregon, has established a roundabout education program that is primarily focused on educating children about how to properly walk or bicycle through a roundabout. With a number of roundabouts within the Bend community, the city's intent was to establish the knowledge at an early age with the hope that children would already understand this type of intersection when they reached the driving age and would also be able to share the valuable knowledge with their parents.

Appendix B provides instructional material and model language for drivers, cyclists, and pedestrians that can be adapted to drivers manuals.

3.9 REFERENCES

1. McCulloch, H. "The Roundabout Design Process—Simplified." National Roundabout Conference. Kansas City, Missouri, 2008. <http://teachamerica.com/RAB08/RAB08S3BMcCulloch/index.htm>. Accessed July 30, 2009.
2. Rodegerdts, L., M. Blogg, E. Wemple, E. Myers, M. Kyte, M. Dixon, G. List, A. Flannery, R. Troutbeck, W. Brilon, N. Wu, B. Persaud, C. Lyon, D. Harkey, and D. Carter. *NCHRP Report 572: Roundabouts in the United States*. Transportation Research Board of the National Academies, Washington, D.C., 2007.
3. *Manual on Uniform Traffic Control Devices*. FHWA, Washington, D.C., 2009.
4. *Transportation Planning Handbook*, 3rd ed. Institute of Transportation Engineers, Washington, D.C., 2009.
5. *A Policy on Design of Urban Highways and Arterial Streets*. AASHO, Washington, D.C., 1973.
6. *A Manual on User Benefit Analysis of Highway and Bus Transit Improvements*. AASHTO, Washington, D.C., 1977.
7. National Safety Council. "Estimating the Cost of Unintentional Injuries." www.nsc.org/news_resources/injury_and_death_statistics/Pages/EstimatingtheCostsofUnintentionalInjuries.aspx. Accessed March 2010.
8. *Intelligent Transportation Systems for Traffic Signal Control, Deployment Benefits and Lessons Learned*. Report No. FHWA-JPO-07-004. U.S. Department of Transportation, FHWA, Washington, D.C., 2007.
9. Koonce, P., L. Rodegerdts, K. Lee, S. Quayle, S. Beard, C. Braud, J. Bonneson, P. Tarnoff, and T. Urbanik. *Traffic Signal Timing Manual*. Report No. FHWA-HOP-08-024. FHWA, Washington, D.C., 2008.
10. *Status Report*, Volume 36, Number 7. Insurance Institute of Highway Safety, Arlington, Virginia, 2001.
11. Barnet, B. F. and city of Springfield, Oregon. "Anatomy of Education and Outreach to Inform Elected Officials, Community Leaders, and Citizens." Poster from Transportation Research Board National Roundabout Conference, Kansas City, Missouri, 2008.
12. Maryland State Highway Administration. "Traveling Maryland's Roundabouts." www.sha.state.md.us/Safety/oos/Roundabouts/info.asp. Accessed November 2008.
13. City of Sammamish, Washington. "Roundabout Demonstration." www.ci.sammamish.wa.us/RoundaboutDemo.aspx?Show=Main. Accessed November 2008.

Roundabouts: An Informational Guide

14. City of Modesto, California. "Roundabouts." Traffic Engineering Division. www.ci.modesto.ca.us/PWD/traffic/roundabouts/videos.asp. Accessed November 2008.
15. Washington State Department of Transportation, city of Lacey, and city of Olympia. "Driving Modern Roundabouts." www.wsdot.wa.gov/eesc/CAE/designvisualization/video/portfolio/Modern_Roundabouts/mpg_index.htm. Accessed November 2008.
16. Virginia Department of Transportation. Roundabouts in Virginia. www.virginiadot.org/info/faq-roundabouts.asp. Accessed March 2009.

CHAPTER 4

OPERATIONAL ANALYSIS

CONTENTS

4.1 INTRODUCTION	4-3
4.2 PRINCIPLES	4-3
4.2.1 Effect of Traffic Flow and Driver Behavior	4-4
4.2.2 Effect of Geometry	4-5
4.3 DATA COLLECTION AND ANALYSIS	4-6
4.3.1 Field Data Collection	4-6
4.3.2 Determining Roundabout Flow Rates	4-6
4.4 ANALYSIS TECHNIQUES	4-10
4.5 HIGHWAY CAPACITY MANUAL METHOD	4-10
4.5.1 Adjustments for Vehicle Fleet Mix	4-11
4.5.2 Entry Capacity	4-11
4.5.3 Right-Turn Bypass Lanes	4-13
4.5.4 Effect of Pedestrians on Vehicular Operations at the Entry	4-13
4.5.5 Volume-to-Capacity Ratio	4-14
4.5.6 Control Delay	4-15
4.5.7 Quality of Service and Level of Service	4-16
4.5.8 Geometric Delay	4-17
4.5.9 Queue Length	4-17
4.5.10 Reporting of Results	4-18
4.6 DETERMINISTIC SOFTWARE METHODS	4-18
4.7 SIMULATION METHODS	4-19
4.8 REFERENCES	4-20

LIST OF EXHIBITS

Exhibit 4-1 Calculation of Circulating Flow 4-7

Exhibit 4-2 Calculation of Exiting Flow 4-7

Exhibit 4-3 Conversion of Turning-Movement Volumes
to Roundabout Volumes 4-8

Exhibit 4-4 Selection of Analysis Tool 4-10

Exhibit 4-5 Passenger Car Equivalencies 4-11

Exhibit 4-6 Entry Lane Capacity 4-12

Exhibit 4-7 Entry Capacity Adjustment Factor for Pedestrians
Crossing a One-Lane Entry (Assuming Pedestrian Priority) 4-14

Exhibit 4-8 Entry Capacity Adjustment Factor for Pedestrians
Crossing a Two-Lane Entry (Assuming Pedestrian Priority) 4-14

Exhibit 4-9 Level-of-Service Criteria 4-16

4.1 INTRODUCTION

This chapter presents methods for analyzing the operation of an existing or planned roundabout. The methods allow a transportation analyst to assess the operational performance of a facility, given information about the usage of the facility and its geometric design elements. An operational analysis produces two kinds of estimates: (1) the capacity of a facility (i.e., the ability of the facility to accommodate various streams of users) and (2) the level of performance, often using one or more measures of effectiveness, such as delay and queues.

The *Highway Capacity Manual* (HCM)(1) defines the *capacity* of a facility as “the maximum hourly rate at which persons or vehicles can reasonably be expected to traverse a point or uniform section of a lane or roadway during a given time period under prevailing roadway, traffic, and control conditions.” While capacity is a specific measure that can be defined and estimated, *level of service (LOS)* is a qualitative measure that “characterizes operational conditions within a traffic stream and their perception by motorists and passengers.” To quantify LOS, the HCM defines specific measures of effectiveness for each highway facility type. *Control delay* is the measure of effectiveness that is used to define level of service at intersections as perceived by users. In addition to control delay, all intersections cause some drivers to also incur *geometric delay* when making turns. A systems analysis of a roadway network may include geometric delay because of the slower vehicle paths required for turning through intersections.

While an operational analysis can be used to evaluate the performance of an existing roundabout during a base or future year, its more common function in the United States may be to evaluate new roundabout designs.

This chapter:

- Presents the principles of roundabout operations,
- Presents a method to estimate the capacity of five of the six basic roundabout configurations presented in this guide,
- Describes the measures of effectiveness used to determine the performance of a roundabout and a method to estimate these measures, and
- Briefly describes the computer software packages available to implement the capacity and performance analysis procedures.

4.2 PRINCIPLES

The operational performance of roundabouts is relatively simple, although the techniques used to model performance can be quite complex. A few features are common to the modeling techniques employed by all analysis tools:

- Drivers must yield the right-of-way to circulating vehicles and accept gaps in the circulating traffic stream. Therefore, the operational performance of a roundabout is directly influenced by traffic patterns and gap acceptance characteristics.

- As with other types of intersections, the operational performance of a roundabout is directly influenced by its geometry. The extent to which this influence is affected in the aggregate (e.g., number of lanes) or by design details (e.g., diameter) is discussed in more detail in this section.

The following sections discuss these principles in more detail.

4.2.1 EFFECT OF TRAFFIC FLOW AND DRIVER BEHAVIOR

The capacity of a roundabout entry decreases as the conflicting flow increases. In general, the primary conflicting flow is the circulating flow that passes directly in front of the subject entry. When the conflicting flow approaches zero, the maximum entry flow is given by 3,600 seconds per hour divided by the follow-up headway, which is analogous to the saturation flow rate for a movement receiving a green indication at a signalized intersection. This defines the intercept of the capacity model.

A variety of real-world conditions occur that can affect the accuracy of a given modeling technique. The analyst is cautioned to consider these effects and determine whether they are significant for the type of analysis being performed. For example, the level of accuracy needed for a rough planning-level sizing of a roundabout is considerably less than that needed to determine the likelihood of queue spillback between intersections. Some of these conditions include the following (1):

- *Effect of exiting vehicles.* While the circulating flow directly conflicts with the entry flow, the exiting flow may also affect a driver's decision on when to enter the roundabout. This phenomenon is similar to the effect of the right-turning stream approaching from the left side of a two-way stop-controlled intersection. Until these drivers complete their exit maneuver or right turn, there may be some uncertainty in the mind of the driver at the yield or stop line about the intentions of the exiting or turning vehicle.
- *Changes in effective priority.* When both the entering and conflicting flow volumes are high, limited priority (where circulating traffic adjusts its headways to allow entering vehicles to enter), priority reversal (where entering traffic forces circulating traffic to yield), and other behaviors may occur, and a simplified gap-acceptance model may not give reliable results.
- *Capacity constraint.* When an approach operates over capacity during the analysis period, a condition known as *capacity constraint* may occur. During this condition, the actual circulating flow downstream of the constrained entry will be less than the demand. The reduction in actual circulating flow may therefore increase the capacity of the affected downstream entries.
- *Origin–destination patterns.* Origin–destination patterns may have an influence on the capacity of a given entry.

As noted in the HCM, capacities measured in the United States have been generally lower than observed in other countries. Roundabout design practices and the public's use of roundabouts are still maturing in the United States. Much

of the data available at the time of publication of the 2010 HCM dates to 2003, when fewer roundabouts operating at capacity were available for study in the United States. It is therefore probable that capacities will increase over time as drivers become more familiar and as demands on existing roundabouts force drivers to improve efficiency.

The extent to which this increase will occur, and whether this increase will cause capacities in the United States to match international observations, is an open question. It has been argued that capacities in the United States over time may still be different from those observed in other countries due to a variety of factors:

- Limited use of turn indicators at roundabout exits,
- Differences in vehicle fleet mixes, and
- Much more common use of stop-controlled intersections (versus yield-controlled intersections) in the United States.

4.2.2 EFFECT OF GEOMETRY

Geometry plays a significant role in the operational performance of a roundabout in a number of key ways:

- It affects the speed of vehicles through the intersection, thus influencing their travel time by virtue of geometry alone (geometric delay).
- It dictates the number of lanes over which entering and circulating vehicles travel. The widths of the approach roadway and entry determine the number of vehicle streams that may form side-by-side at the yield line and govern the rate at which vehicles may enter the circulating roadway.
- It can affect the degree to which flow in a given lane is facilitated or constrained. For example, the angle at which a vehicle enters affects the speed of that vehicle, with entries that are more perpendicular requiring slower speeds and thus longer headways. Likewise, the geometry of multilane entries may influence the degree to which drivers are comfortable entering next to one another.
- It may affect the driver's perception of how to navigate the roundabout and their corresponding lane choice approaching the entry. Improper lane alignment can increase friction between adjacent lanes and thus reduce capacity. Imbalanced lane flows on an entry can increase the delay and queuing on an entry despite the entry operating below its theoretical capacity.

Thus, the geometric elements of a roundabout, together with the volume of traffic desiring to use a roundabout at a given time, may determine the efficiency with which a roundabout operates. These elements form the core of commonly used models, including the Kimber model from the United Kingdom (2). Recent U.S.-based research has suggested that while aggregate changes in geometry are statistically significant, minor changes in geometry are masked by the large variation in behavior from driver to driver (3). As a result, the extent to which geometry is modeled depends on the available data and the modeling technique employed.

4.3 DATA COLLECTION AND ANALYSIS

4.3.1 Field Data Collection

Operational analysis of roundabouts requires the collection or projection of peak period turning-movement volumes. For existing conventional intersections, these can be determined using standard techniques (4). For existing roundabouts, turning movements can be collected using a variety of techniques:

- *Live recording of turning-movement patterns using field observers.* This is only feasible under low-volume conditions where the entire roundabout is visible from one location.
- *Video recording of the entire intersection, followed by manual extraction of turning movements from the video.* This technique is feasible under any volume condition but usually requires all of the turning movements to be visible from one location. Multiple video locations can be used, but they must be carefully synchronized for successful data extraction.
- *Field observers at each of the exits, manually recording vehicles approaching the exit.*
- *Link counters placed across each entry, each exit, and the circulatory roadway in front of each splitter island, plus manual counting of right-turn movements.*
- *Origin-destination survey techniques.* This is generally more effective when multiple intersections are being studied simultaneously.

Operational performance of a roundabout can also be measured directly in the field using a variety of techniques:

- Control delay can be estimated by measuring the average time it takes vehicles to travel between a control point upstream of the maximum queue in a lane and a point immediately downstream of the entry. The control delay is the difference between this measured travel time and the travel time needed by an unconstrained vehicle (one that did not queue or need to yield at entry).
- Geometric delay can be estimated by comparing the travel time of an unconstrained vehicle passing through a roundabout to that needed by an unconstrained vehicle that does not pass through the geometric features of the roundabout (either measured before construction or estimated). Geometric delay is of particular importance when comparing travel times along a corridor.

Note that field measurement of performance measures may require large sample sizes due to the inherent large variability in delay measures.

4.3.2 DETERMINING ROUNDABOUT FLOW RATES

The manual technique presented in this document requires the calculation of entering, circulating, and exiting flow rates for each roundabout leg. Although the following sections present a numerical methodology for a four-leg roundabout, this methodology can be extended to any number of legs.

The circulating flow rate opposing a given entry is defined as the flow conflicting with the entry flow of that leg. The movements that contribute to the

northbound circulating flow rate are illustrated in Exhibit 4-1. In this exhibit, $v_{c,NB}$ is the circulating flow rate in front of the northbound entry, and the contributing movements are the eastbound through (EBT), eastbound left-turn (EBL), eastbound U-turn (EBU), southbound left-turn (SBL), southbound U-turn (SBU), and westbound U-turn (WBU) movements.

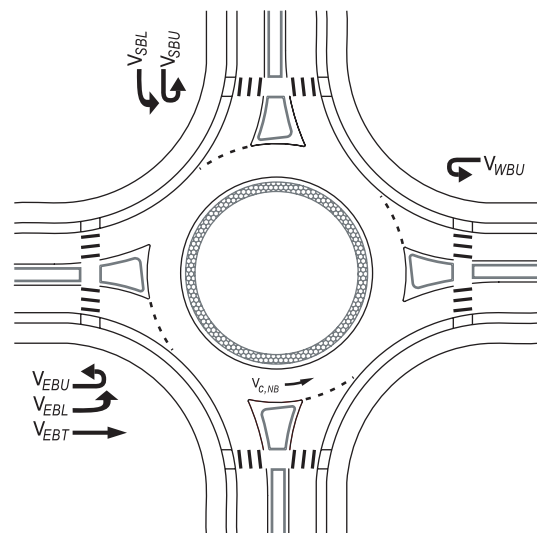

Exhibit 4-1
Calculation of Circulating Flow

The exiting flow rate for a given leg is used primarily in the calculation of conflicting flow for right-turn bypass lanes and in determining queuing at exit-side crosswalks. The exiting flow calculation for the southbound exit is illustrated in Exhibit 4-2. If a bypass lane is present on the immediate upstream entry, the right-turning flow using the bypass lane is deducted from the exiting flow. In this exhibit, $v_{ex,SB}$ is the southbound exiting flow rate, and the contributing movements are the eastbound right-turn (EBR), southbound through (SBT), westbound left (WBL), and northbound U-turn (NBU) movements.

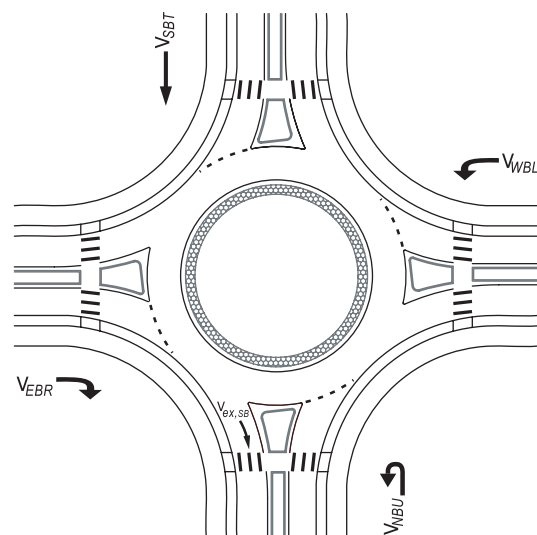

Exhibit 4-2
Calculation of Exiting Flow

Exhibit 4-3 provides a sample calculation.

Exhibit 4-3
Conversion of Turning-Movement Volumes to Roundabout Volumes

Conversion of Turning-Movement Volumes to Roundabout Volumes

Prior to conducting a roundabout analysis, turning-movement volumes must first be converted to roundabout volumes.

Turning-Movement Data

- Percent heavy vehicles for all movements = 2%
- Peak Hour Factor (PHF) = 0.97

Step 1: Convert Movement Demand Volumes to Flow Rates

Each turning-movement volume given in the problem is converted to a demand flow rate by dividing by the peak-hour factor. As an example, the northbound left volume is converted to a flow rate in passenger cars per hour as follows:

$$v_{NBL} = \frac{V_{NBL}}{PHF} = \frac{145}{0.97} = 149 \text{ pc/h}$$

Step 2: Adjust Flow Rates for Heavy Vehicles

The flow rate for each movement may be adjusted to account for vehicle stream characteristics as follows (northbound left turn illustrated):

$$f_{HV} = \frac{1}{1 + P_T(E_T - 1)} = \frac{1}{1 + 0.02(2 - 1)} = 0.980$$

$$v_{NBL,pce} = \frac{v_{NBL}}{f_{HV}} = \frac{149}{0.980} = 152 \text{ pc/h}$$

The resulting adjusted flow rates for all movements accounting for Steps 1 and 2 are therefore computed as follows:

Conversion of Turning-Movement Volumes to Roundabout Volumes

Step 3: Determine Entry Flow Rates by Lane

The entry flow rate is calculated by summing up the movement flow rates that enter the roundabout. For single-lane roundabouts, all approach volumes are summed together. Additional lane-use calculations are required for multilane roundabouts.

The entry flow rates are calculated as follows for the south leg (northbound entry):

$$v_{e,NB,pce} = v_{NBU,pce} + v_{NBL,pce} + v_{NBT,pce} + v_{NBR,e,pce}$$

$$= 0 + 152 + 220 + 79 = 451 \text{ pc/h}$$

Step 4: Determine Circulating Flow Rates

The circulating flow is calculated for each leg. The circulating volumes are the sum of all volumes that will conflict with entering vehicles on the subject approach. For the south leg (northbound entry), the circulating flow is calculated as follows:

$$v_{c,NB,pce} = v_{WBU,pce} + v_{SBL,pce} + v_{SBU,pce} + v_{EBT,pce} + v_{EBL,pce} + v_{EBU,pce}$$

$$= 0 + 268 + 0 + 315 + 258 + 0 = 841 \text{ pc/h}$$

Step 5: Determine Exiting Flow Rates

The exiting flow is calculated for each leg by summing all flow that will be exiting the roundabout on a particular leg. For the south leg (northbound entry), the exiting volume is calculated as follows:

$$v_{ex,pce,NB} = v_{NBU,pce} + v_{WBL,pce} + v_{SBU,pce} + v_{EBR,e,pce}$$

$$= 0 + 105 + 100 + 110 = 315 \text{ pc/h}$$

Result

The following figure illustrates the final volumes converted into roundabout entering, exiting, and circulating flow rates.

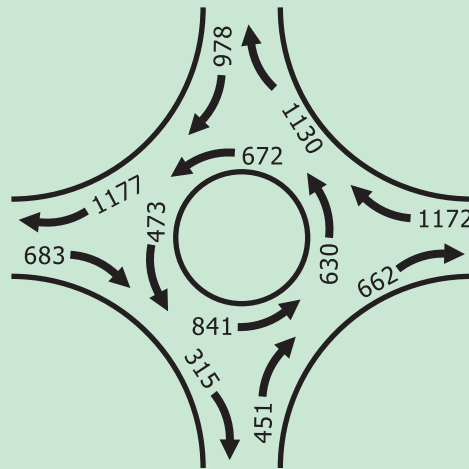

Exhibit 4-3 (cont.)

Conversion of Turning-Movement Volumes to Roundabout Volumes

4.4 ANALYSIS TECHNIQUES

A variety of methodologies are available to analyze the performance of roundabouts. All are approximations, and the responsibility is with the analyst to use the appropriate tool for conducting the analysis.

The decision on the type of operational analysis method to employ should be based on a number of factors:

- What data are available?
- Can the method satisfy the output requirements?

Exhibit 4-4 presents a summary, rather than an exhaustive list, of common applications of operational analysis tools, along with the outcome typically desired and the types of input data usually available. Note that the outcome desired is distinct from the output of the analysis tool. For example, the lane configuration is commonly determined through an iterative process of assigning lane configurations as inputs to the analysis tool and then assessing the acceptability of the resultant performance measures.

Exhibit 4-4
Selection of Analysis Tool

Application	Typical Outcome Desired	Input Data Available	Potential Analysis Tool
Planning-level sizing	Number of lanes	Traffic volumes	Section 3.5 of this guide, HCM, deterministic software
Preliminary design of roundabouts with up to two lanes	Detailed lane configuration	Traffic volumes, geometry	HCM, deterministic software
Preliminary design of roundabouts with three lanes and/or with short lanes/flared designs	Detailed lane configuration	Traffic volumes, geometry	Deterministic software
Analysis of pedestrian treatments	Vehicular delay, vehicular queuing, pedestrian delay	Vehicular traffic and pedestrian volumes, crosswalk design	HCM, deterministic software, simulation
System analysis	Travel time, delays and queues between intersections	Traffic volumes, geometry	HCM, simulation
Public involvement	Animation of no-build conditions and proposed alternatives	Traffic volumes, geometry	Simulation

In addition to the planning method in Section 3.5 of this guide, three basic types of analysis are suggested in the above table: HCM method, deterministic software, and simulation. These are presented in detail in the following sections.

4.5 HIGHWAY CAPACITY MANUAL METHOD

The analytic method presented in the 2010 HCM represents a major update of the method presented in the 2000 edition. It is largely based on a recent study of roundabout operations for U.S. conditions based on a study of 31 sites (1, 3). The

procedures allow the assessment of the operational performance of an existing or planned one-lane or two-lane roundabout given traffic-demand levels.

This section presents an overview of key elements **but not a complete representation** of the HCM method; details and sample problems can be found in the HCM (1). The HCM method and subsequent interpretations, corrections, and changes approved by the Transportation Research Board's Committee on Highway Capacity and Quality of Service should take precedence over the content in this chapter.

4.5.1 ADJUSTMENTS FOR VEHICLE FLEET MIX

The flow rate for each movement may be adjusted to account for vehicle stream characteristics using factors given in Exhibit 4-5. Note that the capacity equations given in this chapter implicitly incorporate these factors. As a result, adjustments to these factors should be done only in conjunction with reviewing the effect of those adjustments on others factors (e.g., critical headway and follow-up time).

Vehicle Type	Passenger Car Equivalent, E_T
Passenger Car	1.0
Heavy Vehicle	2.0
Bicycle	0.5

The calculation to incorporate these values is given in Equation 4-1 and Equation 4-2 (HCM):

$$v_{i,pce} = \frac{v_i}{f_{HV}}$$

$$f_{HV} = \frac{1}{1 + P_T(E_T - 1)}$$

where

- $v_{i,pce}$ = demand flow rate for movement i , pc/h;
- v_i = demand volume for movement i , veh/h;
- f_{HV} = heavy vehicle adjustment factor;
- P_T = proportion of demand volume that consists of heavy vehicles; and
- E_T = passenger car equivalent for heavy vehicles.

4.5.2 ENTRY CAPACITY

Based on national research, the HCM employs a number of simple, empirical regression models to reflect the capacity of roundabouts with up to two lanes.

The capacity of an entry lane opposed by one circulating lane [e.g., a one-lane entry to a one-lane roundabout, or either lane of a two-lane entry conflicted by one circulating lane (for example, Exhibit A-3 of Appendix A)] is based on the conflicting flow. The equation for estimating the capacity is given as Equation 4-3.

$$c_{e,pce} = 1,130e^{(-1.0 \times 10^{-3})v_{c,pce}}$$

where

- $c_{e,pce}$ = lane capacity, adjusted for heavy vehicles, pc/h; and
- $v_{c,pce}$ = conflicting flow, pc/h.

Exhibit 4-5
Passenger Car Equivalencies

Equation 4-1

Equation 4-2

Equation 4-3

Equation 4-4 gives the capacity of a one-lane roundabout entry opposed by two conflicting lanes as follows:

Equation 4-4

$$c_{e,pce} = 1,130e^{(-0.7 \times 10^{-3})v_{c,pce}}$$

where all variables are as given previously.

Equation 4-5 and Equation 4-6 give the capacity of the right and left lanes, respectively, of a two-lane roundabout entry opposed by two conflicting lanes:

Equation 4-5

$$c_{e,R,pce} = 1,130e^{(-0.7 \times 10^{-3})v_{c,pce}}$$

Equation 4-6

$$c_{e,L,pce} = 1,130e^{(-0.75 \times 10^{-3})v_{c,pce}}$$

where

- $c_{e,R,pce}$ = capacity of the right entry lane, adjusted for heavy vehicles, pc/h;
- $c_{e,L,pce}$ = capacity of the left entry lane, adjusted for heavy vehicles, pc/h; and
- $v_{c,pce}$ = conflicting flow, pc/h.

The capacity of the left lane of a roundabout approach is lower than the capacity of the right lane.

Exhibit 4-6 presents a plot showing Equation 4-3, Equation 4-5, and Equation 4-6. The dashed lines represent portions of the curves that lie outside the range of observed field data.

Exhibit 4-6
Entry Lane Capacity

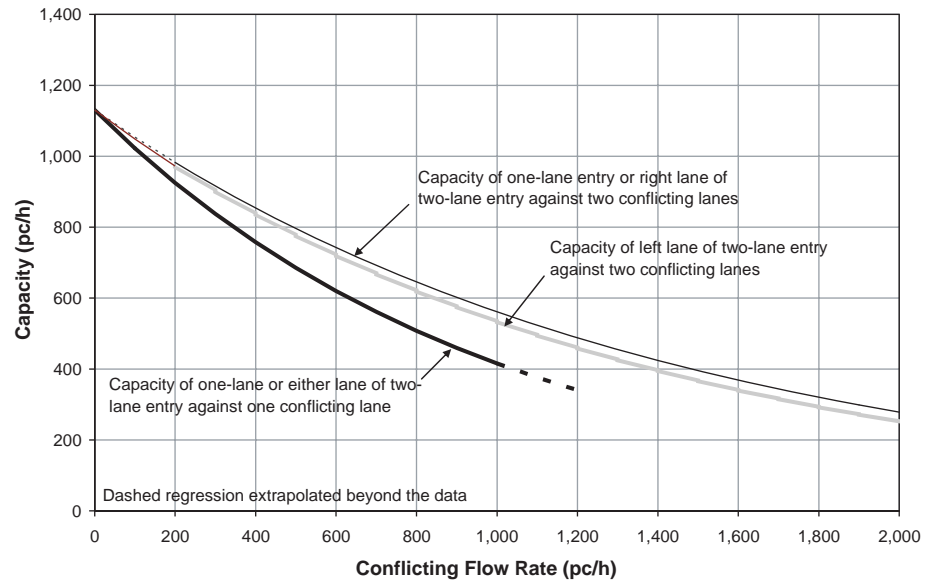

Each of the capacity models given above reflects observations made at U.S. roundabouts in 2003. As noted previously, it is probable that U.S. roundabout capacity will increase to some degree over time with increased driver familiarity. In addition, communities with higher densities of roundabouts and/or generally more aggressive drivers may experience higher capacities. Therefore, local calibration of the capacity models is recommended to best reflect local driver behavior. This is discussed further in the HCM.

4.5.3 RIGHT-TURN BYPASS LANES

Right-turn bypass lanes are right-turn lanes that do not share the same entrance line with the lanes designated for through and left-turning vehicles. Two common types of right-turn bypass lanes are used at single-lane and multilane roundabouts: (1) where bypass traffic yields to conflicting exiting vehicles (sometimes referred to as a partial bypass lane), and (2) where the bypass lane joins the intersecting roadway as an additional lane or in a downstream merging operation.

The capacity for a yielding bypass lane opposed by one exiting lane can be approximated using Equation 4-7.

$$C_{bypass,pce} = 1,130e^{(-1.0 \times 10^{-3})v_{ex,pce}}$$

Equation 4-7

The capacity for a yielding bypass lane opposed by two exiting lanes can be approximated using Equation 4-8.

$$C_{bypass,pce} = 1,130e^{(-0.7 \times 10^{-3})v_{ex,pce}}$$

Equation 4-8

where

$C_{bypass,pce}$ = capacity of the bypass lane, adjusted for heavy vehicles, pc/h; and
 $v_{ex,pce}$ = conflicting exiting flow, pc/h.

The capacity of a bypass lane that merges at a low angle with exiting traffic or forms a new lane adjacent to exiting traffic (non-yielding bypass lane) has not been assessed in the United States. Its capacity is expected to be relatively high due to a merging operation between two traffic streams at similar speeds.

4.5.4 EFFECT OF PEDESTRIANS ON VEHICULAR OPERATIONS AT THE ENTRY

Pedestrian traffic can reduce the vehicular capacity of a roundabout entry if sufficient pedestrians are present and they assert the right-of-way typically granted pedestrians in most jurisdictions. Under high vehicular conflicting flows, pedestrians typically pass between queued vehicles on entry, resulting in negligible additional impact to vehicular entry capacity. However, under low vehicular conflicting flows, pedestrians can function effectively as additional conflicting vehicles and reduce the vehicular capacity of the entry. The effect of pedestrians is more pronounced with increased pedestrian volume.

For roundabout entries opposed by one circulating lane, the model shown in Exhibit 4-7 can be used to approximate this effect (2); for entries opposed by two circulating lanes, the model shown in Exhibit 4-8 can be used. These equations are based on the assumption that pedestrians have absolute priority. Supporting equations can be found in the HCM.

Regardless of the analysis method used, vehicular yielding rates vary depending on crossing treatment, number of lanes, posted speed limit, and within individual sites (5). This makes modeling of pedestrian interactions imprecise. As a result, models to analyze pedestrian effects on vehicular capacity or vehicular effects on pedestrian travel should recognize the approximate nature of the adjustment. For locations with high pedestrian volumes or where more precise estimates of capacity effects are desired, a comparison to other analysis methods may be appropriate.

Roundabouts: An Informational Guide

Exhibit 4-7
Entry Capacity Adjustment
Factor for Pedestrians
Crossing a One-Lane
Entry (Assuming Pedestrian
Priority)

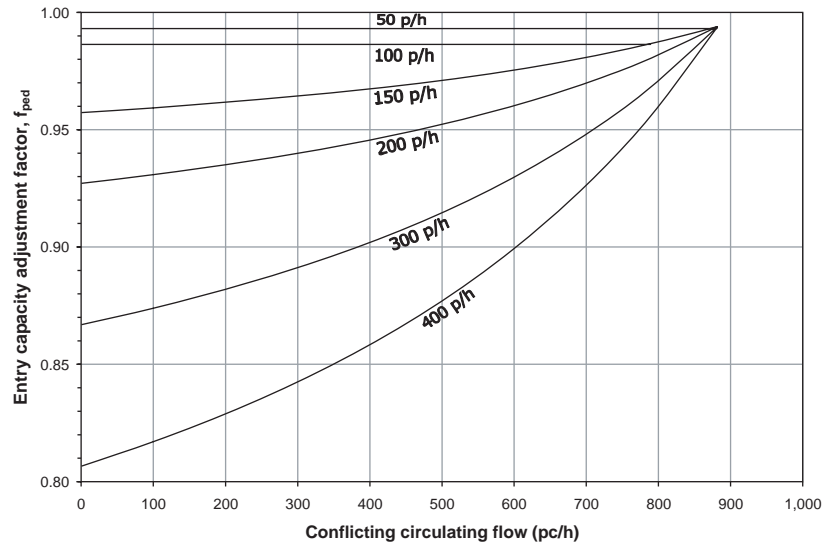
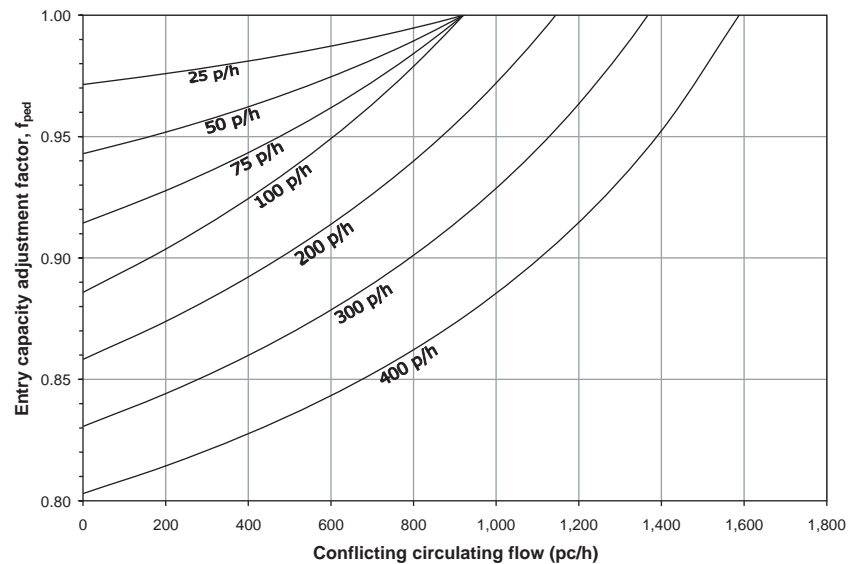

Exhibit 4-8
Entry Capacity Adjustment
Factor for Pedestrians
Crossing a Two-Lane
Entry (Assuming Pedestrian
Priority)



4.5.5 VOLUME-TO-CAPACITY RATIO

The volume-to-capacity ratio is a comparison of the demand at the roundabout entry to the capacity of the entry and provides a direct assessment of the sufficiency of a given design. For a given lane, the volume-to-capacity ratio, x , is calculated by dividing the lane’s calculated capacity into its demand flow rate, as shown in Equation 4-9. Both input values are in vehicles per hour.

Equation 4-9

$$x = \frac{v}{c}$$

While the HCM does not define a standard for volume-to-capacity ratio, international and domestic experience suggests that volume-to-capacity ratios in the range of 0.85 to 0.90 represent an approximate threshold for satisfactory operation. When the degree of saturation exceeds this range, the operation of the roundabout

enters a more unstable range in which conditions could deteriorate rapidly, particularly over short periods of time. Queues that carry over from one 15-minute period to the next may form, and delay begins to increase exponentially.

A volume-to-capacity ratio of 0.85 should not be considered an absolute threshold; in fact, acceptable operations may be achieved at higher ratios. Where an operational analysis finds the volume-to-capacity ratio above 0.85, it is encouraged to conduct additional sensitivity analysis to evaluate whether relatively small increments of additional volume have dramatic impacts on delay or queues. The analyst is also encouraged to take a closer look at the assumptions used in the analysis (i.e., the accuracy of forecast volumes). A higher volume-to-capacity ratio during peak periods may be a better solution than the potential physical and environmental impacts of excess capacity that is unused most of the day.

4.5.6 CONTROL DELAY

Delay is a standard parameter used to measure the performance of an intersection. The HCM identifies control delay as the primary service measure for signalized and unsignalized intersections, with level of service determined from the control delay estimate. Delay data collected for roundabouts in the United States suggest that control delays can be predicted in a manner similar to that used for other unsignalized intersections. Equation 4-10 shows the model that should be used to estimate average control delay for each lane of a roundabout approach. The HCM only includes control delay, which is the delay attributable to the control device. Control delay is the time that a driver spends decelerating to a queue, queuing, waiting for an acceptable gap in the circulating flow while at the front of the queue, and accelerating out of the queue.

$$d = \frac{3,600}{c} + 900T \left[x - 1 + \sqrt{(x-1)^2 + \frac{\left(\frac{3,600}{c}\right)x}{450T}} \right] + 5 \cdot \min[x, 1]$$

Equation 4-10

where:

d = average control delay, s/veh;

x = volume-to-capacity ratio of the subject lane;

c = capacity of subject lane, veh/h; and

T = time period, h ($T = 1$ for a 1-h analysis, $T = 0.25$ for a 15-min analysis).

Average control delay for a given lane is a function of the lane's capacity and degree of saturation. The analytical model used above to estimate average control delay assumes that there is no residual queue at the start of the analysis period. If the degree of saturation is greater than about 0.9, the average control delay is significantly affected by the length of the analysis period. In most cases, the recommended analysis period is 15 min. If demand exceeds capacity during a 15-min period, the delay results calculated by the procedure may not be accurate due to the likely presence of a queue at the start of the time period. In addition, the conflicting demand for movements downstream of the movement operating over capacity may not be fully realized (in other words, the flow cannot get past the

oversaturated entry and thus cannot conflict with a downstream entry). In these cases, an iterative approach that accounts for this effect and the carryover of queues from one time period to the next, such as the Kimber–Hollis formulation documented elsewhere (6), may be used.

To make comparisons to other intersection types, it may be useful to compute the average control delay for the roundabout approach or the intersection as a whole. The control delay for an approach is calculated by computing a weighted average of the delay for each lane on the approach, weighted by the volume in each lane. The calculation is shown in Equation 4-11. Note that the volume in the bypass lane should be included in the delay calculation for the approach.

Equation 4-11

$$d_{\text{approach}} = \frac{d_{LL}v_{LL} + d_{RL}v_{RL} + d_{\text{bypass}}v_{\text{bypass}}}{v_{LL} + v_{RL} + v_{\text{bypass}}}$$

The control delay for the intersection as a whole is similarly calculated by computing a weighted average of the delay for each approach, weighted by the volume on each approach. This is shown in Equation 4-12.

Equation 4-12

$$d_{\text{intersection}} = \frac{\sum d_i v_i}{\sum v_i}$$

where:

- $d_{\text{intersection}}$ = control delay for the entire intersection, s/veh;
- d_i = control delay for approach i , s/veh; and
- v_i = flow rate for approach i , veh/h.

4.5.7 QUALITY OF SERVICE AND LEVEL OF SERVICE

The HCM defines quality of service as how well a transportation facility or service operates **from a traveler’s perspective** (1, Chapter 5). Furthermore, the HCM defines LOS as a quantitative stratification of a performance measure or measures that represent that quality of service. For roundabouts, LOS has been defined using control delay (see Section 4.5.6) with criteria given in Exhibit 4-9. As the exhibit notes, LOS F is assigned if the volume-to-capacity ratio of a lane exceeds 1.0 regardless of the control delay. For assessment of LOS at the approach and intersection levels, LOS is based solely on control delay.

The thresholds given in Exhibit 4-9 are the same as defined in the HCM for stop-controlled intersections. All HCM methodologies for unsignalized intersections share a similar equation form for estimating control delay, and thus similar volume-to-capacity ratios produce similar control delays. In addition, drivers at

Exhibit 4-9
Level-of-Service Criteria

Control Delay (s/veh)	Level of Service by Volume-to-Capacity Ratio*	
	v/c ≤ 1.0	v/c >1.0
0–10	A	F
>10–15	B	F
>15–25	C	F
>25–35	D	F
>35–50	E	F
>50	F	F

* For approaches and intersection-wide assessment, LOS is defined solely by control delay.

roundabouts must make judgments about entering gaps similar to those experienced at two-way stop-controlled intersections; these judgments become more challenging at higher volume-to-capacity ratios. As a result, drivers may not perceive the same amount of control delay the same way at roundabouts as they do at signalized intersections. As with any intersection evaluations, LOS is one of several measures (along with volume-to-capacity ratios, control delay, queue length, and other measures) that should be used in the comparison of roundabouts to other intersection types.

4.5.8 GEOMETRIC DELAY

Geometric delay is a component of delay that is present at roundabouts but is not taken into consideration under typical HCM procedures. Geometric delay is the additional time that a single vehicle with no conflicting flows spends slowing down to the negotiation speed, proceeding through the intersection, and accelerating back to normal operating speed. Geometric delay may be an important consideration in network planning (possibly affecting route travel times and choices) or when comparing operations of alternative intersection types. While geometric delay is often negligible for through movements at a signalized or stop-controlled intersection, it can be more significant for turning movements at those intersections and all movements through a roundabout. Calculation of geometric delay requires knowledge of the roundabout geometry as it affects vehicle speeds during entry, negotiation, and exit. Procedures are given in the Australian design guide (7).

For LOS calculations, geometric delay is not needed, as the HCM defines LOS solely on the basis of control delay. However, if deterministic software or simulation tools are used to estimate travel time along a corridor, geometric delay is inherently included in the estimate of travel time. Care is needed when comparing results between models.

4.5.9 QUEUE LENGTH

Queue length is important when assessing the adequacy of the geometric design of the roundabout approaches. The estimated length of a queue can also provide additional insight into the operational performance of a roundabout in comparison to other intersection types. Queue interaction with adjacent intersections or driveways is another important consideration.

The 95th-percentile queue for a given lane on an approach is calculated using Equation 4-13:

$$Q_{95} = 900T \left[x - 1 + \sqrt{(1-x)^2 + \frac{\left(\frac{3,600}{c}\right)x}{150T}} \right] \left(\frac{c}{3,600} \right)$$

Equation 4-13

where:

- Q_{95} = 95th-percentile queue, veh;
- x = volume-to-capacity ratio of the subject lane;
- c = capacity of subject lane, veh/h; and
- T = time period, h ($T = 1$ for a 1-h analysis, $T = 0.25$ for a 15-min analysis).

Key performance measures for roundabouts include volume-to-capacity ratio, delay, and queue length.

The queue length calculated for each lane should be checked against available storage. The queue in each lane may interact with adjacent lanes in one or more ways:

- If queues in adjacent lanes exceed available storage, the queue in the subject lane may be longer than anticipated due to additional queuing from the adjacent lane.
- If queues in the subject lane exceed the available storage for adjacent lanes, the adjacent lane may be starved by the queue in the subject lane.

Should one or more of these conditions occur, the analyst can conduct a sensitivity analysis using the methodology by varying the demand in each lane. The analyst may also use an alternative tool that is sensitive to lane-by-lane effects, as discussed in Section 4.6 of this chapter.

4.5.10 REPORTING OF RESULTS

Each of the performance measures described above provides a unique perspective on the quality of service at which a roundabout will perform under a given set of traffic and geometric conditions. Whenever possible, the analyst should estimate as many of these parameters as possible to obtain the broadest possible evaluation of the performance of a given roundabout design. In all cases, a capacity estimate must be obtained for an entry to the roundabout before a specific performance measure can be computed. The analyst should be particularly careful not to mask deficient performance characteristics of individual approaches or lanes by using potentially misleading aggregated measures. The reader is encouraged to refer to the HCM for further discussion on this important topic.

4.6 DETERMINISTIC SOFTWARE METHODS

A variety of deterministic software methods are available that are anchored to international research and practice. These methods model vehicle flows as flow rates and are commonly sensitive to various flow and geometric features of the roundabout, including lane numbers and arrangements and/or specific geometric dimensions (e.g., entry width, inscribed circle diameter). Some software implementations may include more than one model and employ extensions beyond the original fundamental research. Since 1990, the most commonly employed deterministic software methods in the United States have been based on Australian and British research and practice, although methods developed in France and Germany have seen some limited use.

For example, British research suggests a much stronger correlation between capacity and fine gradations of geometry than research in some other countries, including the United States (2). For example, the research indicates that approach width, entry width, and the effective flare length have the most significant effects on capacity. In addition, the British research found that entry angle and entry radius have a combined significant effect and that diameter has a small effect, only becoming significant with high circulating volumes. Conversely, Australian research has found more significant effects related to traffic flow, including lane-

by-lane assessments and sensitivity to origin–destination patterns. Even though research in the United States has not necessarily confirmed these findings at American roundabouts, the principles embodied in these tools can be useful to guide a designer in making decisions about potential trade-offs in operational performance due to changes in traffic flows or geometric modifications.

As with any analysis procedure, care should be taken to ensure that the procedure is being appropriately applied. Common items to check for include the following:

- *Calibration to local driver behavior.* For analytical-based models, this may involve using locally measured values for gap acceptance parameters or applying global factors that shape the capacity model. For regression-based models, this may involve adjusting the intercept to match field-measured values of follow-up times.
- *Calibration to effective geometry.* For regression-based models that employ continuous variables for key dimensions (e.g., entry width in feet/meters rather than in number of lanes), adjustments for effective geometry should be considered. This is particularly true for single-lane entries that have large curb-to-curb widths to accommodate large vehicles. Regression-based models do not recognize that a large single-lane entry has only one lane and thus may be modeled as a two-lane entry. A common adjustment used in these cases is to assume that a single-lane entry has a maximum entry width of 15 ft (4.5 m) regardless of the actual curb-to-curb width.
- *Lane use and assignment.* Some models are sensitive to lane use and assignment; others are not. Adjustments should be made to account for lane configurations or system effects (e.g., downstream destinations) that might cause traffic to favor one lane over another, thus influencing capacity and performance measures.

4.7 SIMULATION METHODS

A variety of simulation software packages are available to model transportation networks. Several of these are capable of modeling roundabouts, and features change frequently. These models display individual vehicles and thus are sensitive to factors at that level: car-following behavior, lane-changing behavior, and decision-making at junctions (e.g., gap acceptance). Since 1990, the most commonly employed simulation methods in the United States are based on U.S., British, and German research and practice.

As with the deterministic software methods described previously, care should be taken to ensure that the simulation model is being appropriately applied. Common items to check for include the following:

- *Calibration to local driver behavior.* Calibration of stochastic models is more challenging than for deterministic models because some calibration factors, such as those related to driver aggressiveness, often apply globally to all elements of the network and not just to roundabouts. In other cases,

the specific coding of the model can be fine-tuned to reflect localized driver behavior, including look-ahead points for gap acceptance and locations for discretionary and mandatory lane changes.

- *Volume pattern checking.* For network models with dynamic traffic assignment, traffic volumes on a given link may not match what has been measured or projected.

Further guidance on the application of simulation models can be found in the FHWA Traffic Analysis Toolbox (8).

4.8 REFERENCES

1. *2010 Highway Capacity Manual.* Transportation Research Board of the National Academies, Washington, D.C., forthcoming.
2. Kimber, R. M. *The Traffic Capacity of Roundabouts.* TRRL Laboratory Report LR 942. Transport and Road Research Laboratory, Crowthorne, England, 1980.
3. Rodegerdts, L., M. Blogg, E. Wemple, E. Myers, M. Kyte, M. Dixon, G. List, A. Flannery, R. Troutbeck, W. Brilon, N. Wu, B. Persaud, C. Lyon, D. Harkey, and D. Carter. *NCHRP Report 572: Roundabouts in the United States.* Transportation Research Board of the National Academies, Washington, D.C., 2007.
4. Robertson, H. D., J. E. Hummer, and D. C. Nelson, eds. *Manual of Transportation Engineering Studies.* ITE, Washington, D.C., 2000.
5. Fitzpatrick, K., S. Turner, M. Brewer, P. Carlson, B. Ullman, N. Trout, E. S. Park, J. Whitacre, N. Lalani, and D. Lord. *TCRP Report 112/NCHRP Report 562: Improving Pedestrian Safety at Unsignalized Crossings.* Transportation Research Board of the National Academies, Washington, D.C., 2006.
6. Kimber, R. M. and E. M. Hollis. *Traffic Queues and Delays at Road Junction.* Laboratory Report LR 909, TRRL, Crowthorne, England, 1979.
7. *Guide to Traffic Engineering Practice, Part 6: Roundabouts.* Austroads, Sydney, Australia, 1993.
8. FHWA. *Traffic Analysis Toolbox.* ops.fhwa.dot.gov/trafficanalysistools/index.htm. Accessed August 2009.

CHAPTER 5 SAFETY

CONTENTS

5.1 INTRODUCTION	5-4
5.2 PRINCIPLES	5-5
5.2.1 Vehicular Conflicts at Single-Lane Roundabouts	5-6
5.2.2 Vehicular Conflicts at Multilane Roundabouts	5-8
5.2.3 Pedestrian Conflicts	5-10
5.2.4 Bicycle Conflicts	5-13
5.3 OBSERVED SAFETY PERFORMANCE	5-14
5.3.1 Comparisons to Previous Intersection Treatment	5-15
5.3.2 Crash Types	5-16
5.3.3 Pedestrians	5-19
5.3.4 Bicyclists	5-20
5.4 INTERSECTION-LEVEL CRASH PREDICTION METHODOLOGY ..	5-22
5.4.1 Methodology to Evaluate the Safety Performance of an Existing Roundabout	5-22
5.4.2 Application to Network Screening	5-24
5.4.3 Estimating the Safety Benefit of a Contemplated Conversion of an Existing Intersection to a Roundabout	5-25
5.5 APPROACH-LEVEL CRASH PREDICTION METHODOLOGY	5-28
5.5.1 Evaluation of Approach-Level Safety Performance	5-31
5.5.2 Consideration of Approach-Level Model Results for HSM-Type Application	5-32
5.6 REFERENCES	5-34

LIST OF EXHIBITS

Exhibit 5-1 Vehicle Conflict Points for T-Intersections with Single-Lane Approaches	5-6
Exhibit 5-2 Vehicle Conflict Point Comparison for Intersections with Single-Lane Approaches	5-7
Exhibit 5-3 Total and Injury Crash Experience for U.S. Roundabouts with Four Approaches by Number of Lanes and AADT	5-8
Exhibit 5-4 Failing to Maintain Lane Position at a Multilane Roundabout	5-9
Exhibit 5-5 Entering Next to an Exiting Vehicle at a Multilane Roundabout	5-9
Exhibit 5-6 Improper Turn Conflicts at Multilane Roundabouts	5-10
Exhibit 5-7 Vehicle–Pedestrian Conflicts for One Crosswalk at Signalized Intersections	5-11
Exhibit 5-8 Vehicle–Pedestrian Conflicts at Single-Lane Roundabouts	5-12
Exhibit 5-9 Comparisons to Previous Intersection Treatments in the United States	5-15
Exhibit 5-10 Mean Crash Reduction in Various Countries	5-16
Exhibit 5-11 Crash Types at U.S. Roundabouts	5-16
Exhibit 5-12 Comparison of Crash Types at Roundabouts	5-17
Exhibit 5-13 Graphical Depiction of Crash Types at Roundabouts	5-18
Exhibit 5-14 British Crash Rates for Pedestrians at Roundabouts and Signalized Intersections	5-19
Exhibit 5-15 Chance of Pedestrian Death If Hit by a Motor Vehicle	5-19
Exhibit 5-16 Percentage Reduction in the Number of Crashes by Mode in a Dutch Study	5-20
Exhibit 5-17 British Crash Rates for Bicycles and Motorcyclists at Roundabouts and Signalized Intersections	5-20
Exhibit 5-18 A Comparison of Crashes in France Between Signalized Intersections and Roundabouts	5-21
Exhibit 5-19 Intersection-Level Safety Performance Models and Validity Ranges—Total Crashes	5-23
Exhibit 5-20 Intersection-Level Safety Performance Models and Validity Ranges—KAB Injury Crashes	5-23
Exhibit 5-21 Calculation of Total Crashes	5-25
Exhibit 5-22 Calculation of Injury Crashes	5-26
Exhibit 5-23 Calculation of Expected Change in Crashes Converting an Intersection to a Roundabout	5-29
Exhibit 5-24 Entering–Circulating Models	5-31
Exhibit 5-25 Exiting–Circulating Models	5-31

Exhibit 5-26 Approach Models	5-31
Exhibit 5-27 Base Conditions for Design Variables and AMFs Implied for Unit Change in Variables	5-33
Exhibit 5-28 Calculation of Expected Frequency of Entering–Circulating Crashes Using AMFs	5-33

5.1 INTRODUCTION

The use of roundabouts is a proven safety strategy for improving intersection safety by eliminating or altering conflict types, reducing crash severity, and causing drivers to reduce speeds as they proceed into and through intersections. Decreased vehicle speeds will also decrease the speed differentials with other road users. Understanding the sensitivity of safety of the various geometric design elements and traffic exposure will assist the designer in optimizing the safety of all vehicle occupants, pedestrians, and bicyclists. In addition, the use of safety models will facilitate the planning and design of roundabouts by evaluating their safety compared to other intersection types and by quantifying the safety implications of design decisions.

Many studies have found that one of the benefits of the installation of a roundabout is the improvement in overall safety performance. Several studies in the United States, Europe, and Australia have found that roundabouts perform better in terms of safety than other intersection forms (1–4). Recent research using data in the United States (2) found that with the exception of conversions from all-way stop-controlled intersections, where limited data suggest that crash experience remains statistically unchanged, roundabouts have reduced crash frequencies for a wide range of settings (urban, suburban, and rural) and previous forms of traffic control (two-way stop and signal). This is especially evident with less frequent injury crashes. The safety benefit is greater for small- and medium-capacity roundabouts than for large or multilane roundabouts (1, 2, 5). While overall crash frequencies have been reduced, the crash reductions are most pronounced for motor vehicles, less pronounced for pedestrians, and equivocal for bicyclists and motorcyclists depending on the study and bicycle design treatments (4–6).

The reasons for the increased safety level at roundabouts are:

- Roundabouts have fewer vehicular conflict points in comparison to conventional intersections. The potential for high-severity conflicts, such as right angle and left-turn head-on crashes, is greatly reduced with roundabout use.
- Low absolute speeds generally associated with roundabouts allow drivers more time to react to potential conflicts, also helping to improve the safety performance of roundabouts. Low vehicle speeds help reduce crash severity, making fatalities and serious injuries uncommon at roundabouts.
- Since most road users travel at similar speeds through roundabouts (i.e., have low relative speeds), crash severity can be reduced compared to some traditionally controlled intersections.
- Pedestrians need only cross one direction of traffic at a time at each approach as they traverse roundabouts (i.e., crossing in two stages), as compared with many traditional intersections. Pedestrian–vehicle conflict points are reduced at roundabouts; from the pedestrian’s perspective, conflicting vehicles come from fewer directions. In addition, the speeds of motorists entering and exiting a roundabout are reduced with good design, increasing the time available for motorists to react and reducing potential crash severity. While multilane crossings still present a multiple-threat challenge for pedestrians, the overall lower speed environment

helps to reduce the likelihood of collisions. As with other crossings requiring acceptance of gaps, roundabouts present visually impaired pedestrians with unique challenges, as described in Chapter 6.

NCHRP Report 572 (2) presents U.S. data used to develop safety prediction models for both intersection-level and approach-level analyses. The intersection-level models were developed for total and injury collisions; the latter included fatal and definite injury but excluded possible injury collisions (i.e., they include KAB collisions on the *KABCO* scale). The approach-level models were developed for all severities combined for several collision types: entering/circulating, exiting/circulating, and approaching. These models are of a form that is intended to be suitable for eventual inclusion in the *Highway Safety Manual (HSM)* crash prediction procedures, although they are not included in the first edition of that document.

The intersection-level models can be used to evaluate the safety performance of an existing roundabout and in the estimation of the expected safety changes if a roundabout is contemplated for construction at an existing conventional intersection. The approach-level models are presented as tools for evaluating design options or evaluating the safety performance of specific approaches. With respect to roundabout geometry, the following observations pertain to the U.S. data analyzed:

- Entering/circulating collisions increase with an increased entry width.
- Entering/circulating collisions decrease with an increase in central island diameter.
- Entering/circulating collisions decrease as the angle between legs increases.
- Exiting/circulating collisions increase with an increasing inscribed circle diameter.
- Exiting/circulating collisions increase with an increasing central island diameter.
- Exiting/circulating crashes increase with an increasing circulating width.
- Approach crashes increase with increasing lane width.

5.2 PRINCIPLES

The frequency of crashes at an intersection is related to the number of *conflict points* at an intersection, as well as the magnitude of conflicting flows at each conflict point. A conflict point is a location where the paths of two motor vehicles, or a vehicle and a bicycle or pedestrian path, diverge, merge, or cross each other.

Conflicts can arise from both legal and illegal maneuvers; many of the most serious crashes are caused by failure to observe traffic control devices.

The following sections present a variety of conflicts among vehicles, bicycles, and pedestrians. Both legal conflicts (queuing at an intersection, merging into a traffic stream) and conflicts prohibited by law or by traffic control devices (failure to yield to pedestrians, running a stop sign) have been included for completeness. Even though traffic control devices can significantly reduce many conflicts, they

Conflict points occur where one vehicle path crosses, merges or diverges with, or queues behind the path of another vehicle, pedestrian, or bicycle.

cannot eliminate them entirely due to violations of those devices. Many of the most serious crashes are caused by such violations.

As with crash analyses, conflict analyses are more than the simple enumeration of the number of conflicts. A conflict analysis should account for the following factors:

- Existence of conflict point;
- Exposure, measured by the product of the two conflicting stream volumes at a given conflict point;
- Severity, based on the relative velocities of the conflicting streams (speed and angle); and
- Vulnerability, based on the ability for a member of each conflicting stream to survive a crash.

5.2.1 VEHICULAR CONFLICTS AT SINGLE-LANE ROUNDABOUTS

Exhibit 5-1 presents a diagram of vehicle–vehicle conflict points for a traditional three-leg (T) intersection and a three-leg roundabout. As the figure shows, the number of vehicle–vehicle conflict points for roundabouts decreases from nine to six for three-leg intersections. Note that these diagrams do not take into account the ability to separate conflicts in space (through the use of separate left- or right-turning lanes) or time (through the use of traffic control devices such as stop signs or traffic signals).

Roundabouts bring the simplicity of a T-intersection to intersections with more than three legs.

Exhibit 5-1
Vehicle Conflict Points for T-Intersections with Single-Lane Approaches

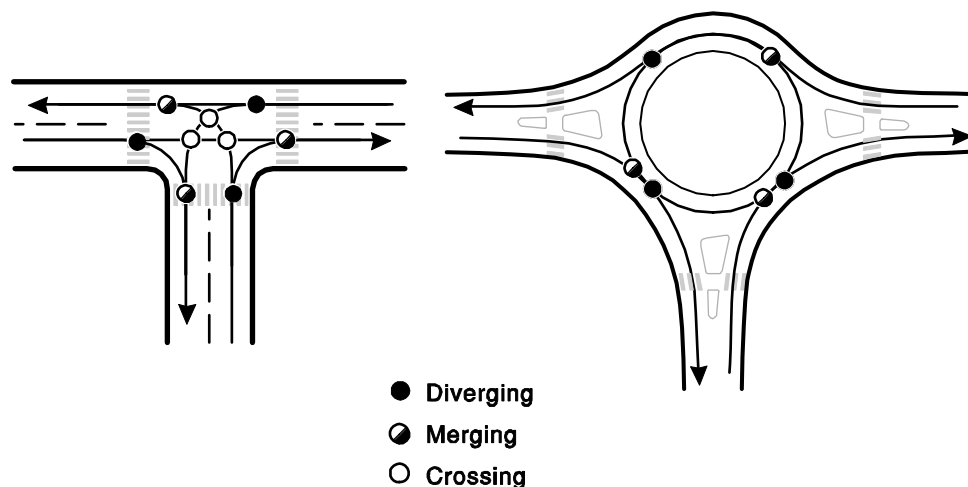

A four-leg single-lane roundabout has 75% fewer vehicle conflict points and no crossing conflict points compared to a conventional intersection.

Exhibit 5-2 presents similar diagrams for a conventional four-leg (X or cross) intersection and a four-leg roundabout. As the figure shows, the number of vehicle–vehicle conflict points for roundabouts decreases from thirty-two to eight with four-leg intersections.

Conflicts can be divided into four basic categories, in which the degree of severity varies, as follows:

1. *Queuing conflicts.* These conflicts are caused by a vehicle running into the back of a vehicle queue on an approach. These types of conflicts can occur at the back of a through-movement queue or where left-turning vehicles

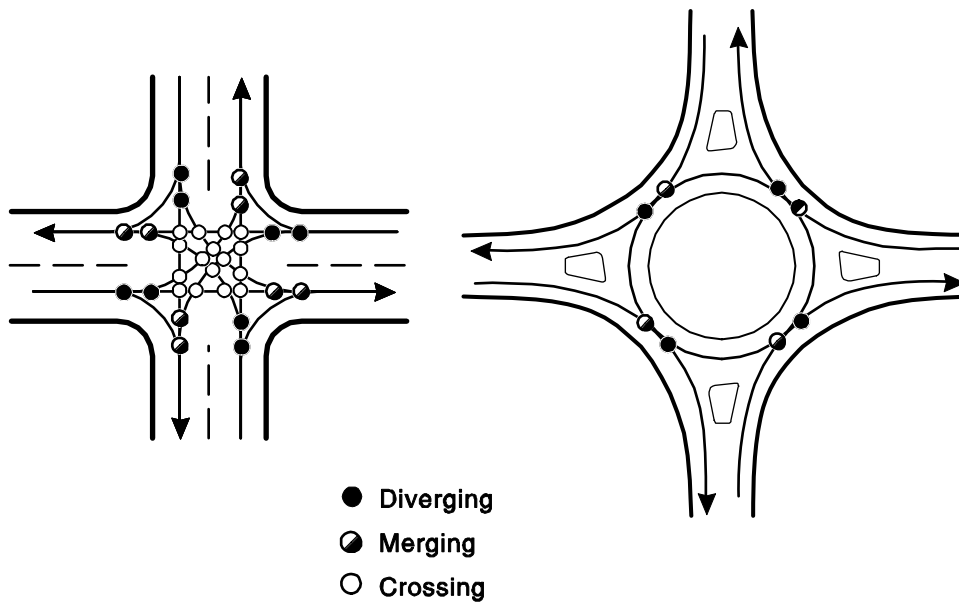

Exhibit 5-2
Vehicle Conflict Point
Comparison for Intersections
with Single-Lane Approaches

are queued waiting for gaps. These conflicts are typically the least severe of all conflicts because the collisions involve the most protected parts of the vehicle and the relative speed difference between vehicles is usually less than other conflicts.

2. *Diverging conflicts.* These conflicts are caused by the separating of two traffic streams. Examples include right turns diverging from through movements or exiting vehicles diverging from circulating vehicles. If the speed of one movement is significantly different from the other movement, the resulting speed differential increases the risk of a rear-end collision.
3. *Merging conflicts.* These conflicts are caused by the joining of two traffic streams. The most common types of crashes due to merging conflicts are side-swipe and rear-end crashes. Merging conflicts can be more severe than diverging conflicts due to the more likely possibility of collisions to the side of the vehicle, which is typically less protected than the front and rear of the vehicle.
4. *Crossing conflicts.* These conflicts occur where the paths of two traffic streams intersect. These are the most severe of all conflicts and the most likely to involve injuries or fatalities. Typical crash types are right-angle crashes and head-on crashes.

As Exhibit 5-1 and Exhibit 5-2 show, a roundabout eliminates vehicular crossing conflicts for both three- and four-leg intersections. Separate turn lanes and traffic control (stop signs or signalization) can often reduce but not eliminate the number of crossing conflicts at a traditional intersection by separating conflicts in space and/or time. However, the most severe crashes at signalized intersections occur when there is a violation of the traffic control device designed to separate conflicts by time (e.g., a right-angle collision due to running a red light and vehicle-pedestrian collisions). Therefore, the ability of single-lane roundabouts to reduce conflicts through physical, geometric features has been demonstrated to be more effective than the reliance on driver obedience of traffic control devices.

 Roundabouts: An Informational Guide

Multilane roundabouts have some of the same safety performance characteristics as single-lane roundabouts but introduce additional conflicts.

Exhibit 5-3
Total and Injury Crash Experience for U.S. Roundabouts with Four Approaches by Number of Lanes and AADT

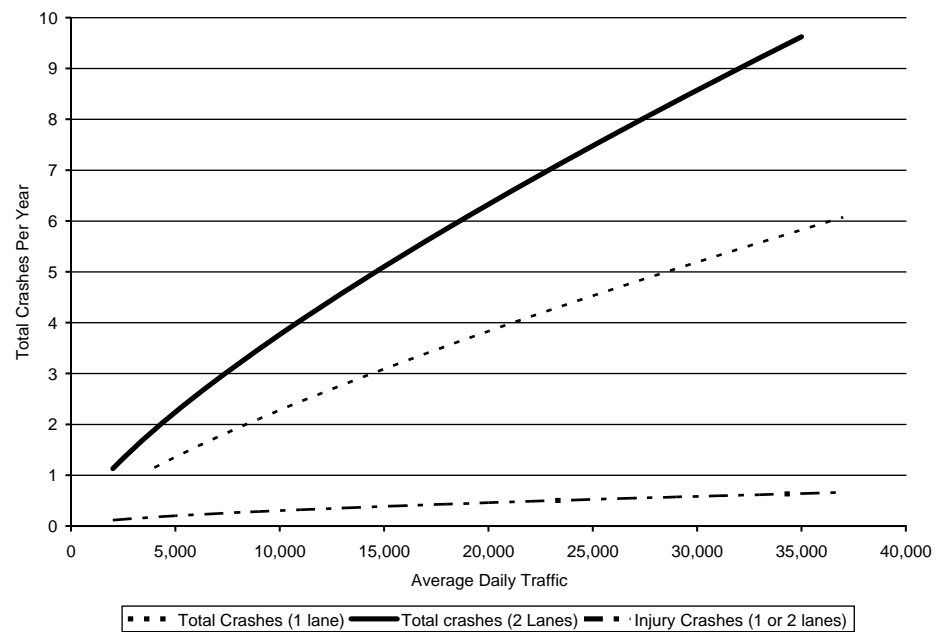

Incorrect lane use and incorrect turns are multilane roundabout conflicts not present in single-lane roundabouts.

The number of vehicular and pedestrian conflict points in both conventional intersections and roundabouts increases considerably when there are additional approach lanes. The designer is encouraged to graphically determine conflicts for a particular location, as this information can raise awareness of design issues and may be useful in public presentations.

Conflicts occur at multilane roundabouts that do not happen at single-lane roundabouts. These can be categorized into three basic types:

- Drivers fail to maintain lane position (Exhibit 5-4),
- Drivers enter next to an exiting vehicle (Exhibit 5-5), and
- Drivers turn from the incorrect lane (Exhibit 5-6).

While these conflicts may also be present at conventional intersections, they can be more prevalent with drivers who are unfamiliar with roundabout operation. The first two types of conflicts, in particular, can be a result of improper roundabout geometry as discussed in Chapter 6, and the latter type of conflict can be a result of improper traffic control devices. Proper driver education may also help to reduce these types of crashes.

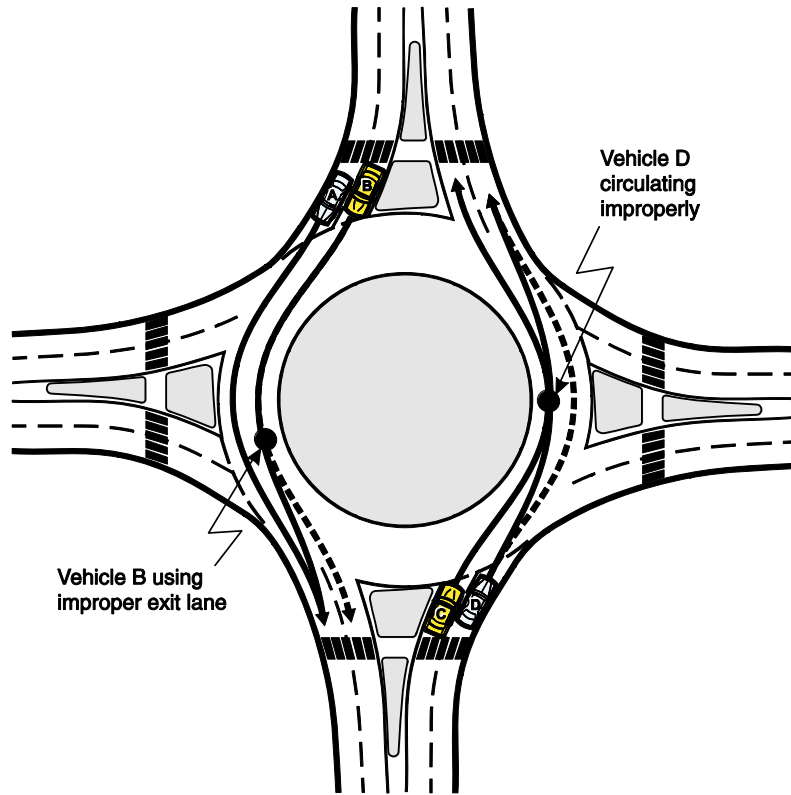

Exhibit 5-4
Failing to Maintain Lane Position at a Multilane Roundabout

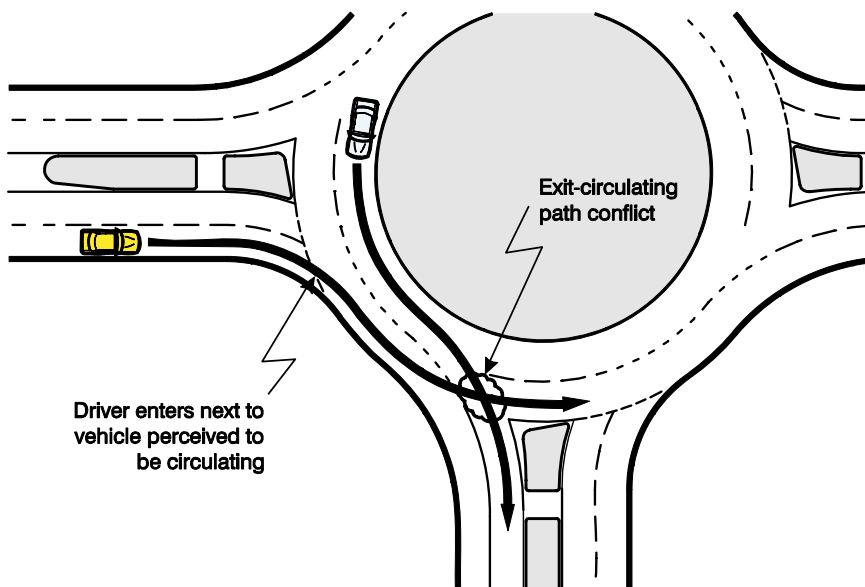
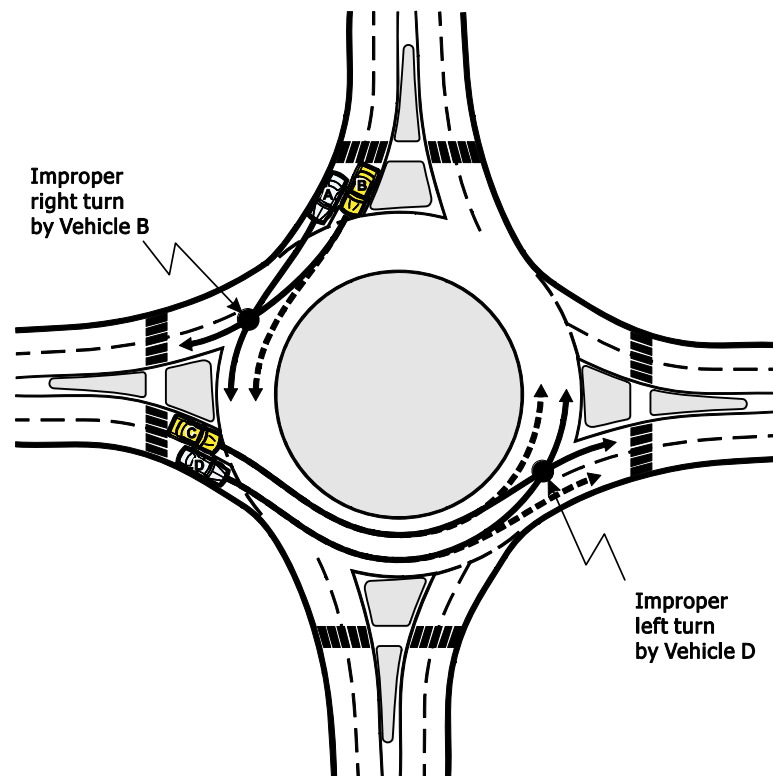

Exhibit 5-5
Entering Next to an Exiting Vehicle at a Multilane Roundabout

As with single-lane roundabouts, the most severe vehicular crossing conflicts are eliminated and replaced by less severe merging conflicts. The additional conflicts unique to multilane roundabouts are generally low-speed side-swipe conflicts that typically have low severity. Therefore, **although the number of conflicts increases at multilane roundabouts when compared to single-lane**

The overall severity (and often number) of conflicts at multi-lane roundabouts is typically less than other intersection alternatives.

Exhibit 5-6
Improper Turn Conflicts at
Multilane Roundabouts



roundabouts, the overall severity (and often number) of conflicts is typically less than other intersection alternatives.

5.2.3 PEDESTRIAN CONFLICTS

Pedestrian-vehicle conflicts can be present at every intersection, even those with minimal pedestrian volume. The following section examines pedestrian conflicts at signalized intersections and at roundabouts.

At conventional intersections, a pedestrian faces four potential vehicular conflicts, each coming from a different direction:

- Left-turn, through, and right-turn movements coming from the leg of the intersection that the pedestrian is crossing;
- Through movements coming from the opposite side of the intersection;
- Right turns from the cross street; and
- Left turns from the cross street.

The amount of exposure and level of severity for each of these conflicts depends significantly on the type of traffic control used:

- *Two-way stop control intersections.* At TWSC intersections, the most significant pedestrian conflict is pedestrians crossing the major street who have potentially severe conflicts with through vehicles on the major street. They also experience less severe conflicts with vehicles making left or right turns from or to the major street. Pedestrians crossing the minor

There are four vehicle-pedestrian crossing conflicts for each crosswalk at conventional intersections.

street generally face less severe conflicts, but conflicts still occur. These include those caused by vehicle drivers making left turns from the major street. In these cases they are looking for gaps in oncoming vehicles and may not see pedestrians crossing the minor street. In addition, drivers turning on to or crossing the major street are focused primarily on vehicles on the major street and may not see pedestrians. This is especially true for drivers turning right from the minor street who may look only to the left for vehicles and not notice pedestrians coming from their right.

- *All-way stop control intersections.* Because all vehicles are required to stop, pedestrian crashes are generally less severe at AWSC intersections. The pedestrian conflicts on the near side of entering drivers are fairly benign. However, as drivers accelerate through the intersection the danger to pedestrians is greater at the far side of the intersection, whether drivers are going straight through or turning. In addition, many drivers roll through stop signs at AWSC intersections once they have perceived that there are no imminent vehicle conflicts. These drivers may occasionally fail to notice pedestrians crossing at the intersection.
- *Signalized intersections.* Traffic signals can potentially reduce the likelihood of pedestrian–vehicle conflicts through the use of signal phasing that allows only a few legal movements at any given time. However, there are four vehicle movements at signalized intersections that create potential conflicts with pedestrians under common signal phasing schemes (see Exhibit 5-7):
 - Red light running (illegal)—includes through movements, left turns, and right turns. These movements, particularly the through movements, have the highest potential severity due to high vehicular speeds and the potential for surprise to the pedestrian.

Four vehicle movements at signalized intersections can result in pedestrian crossing conflicts.

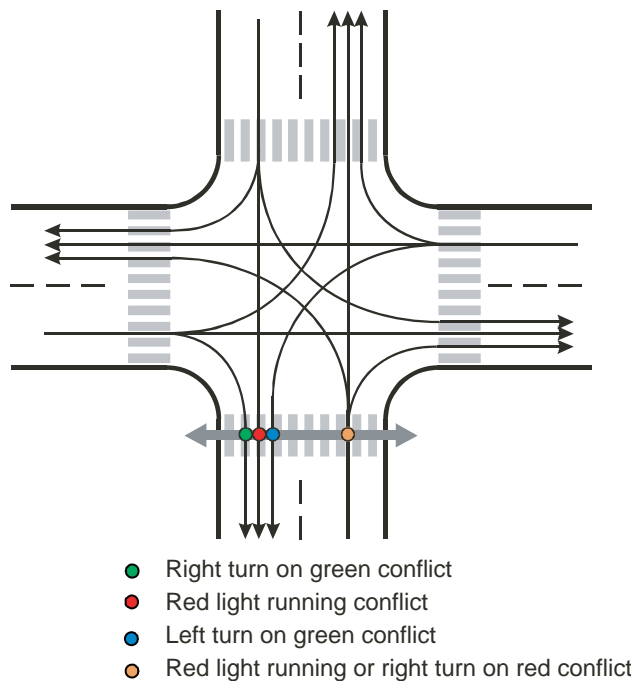

Exhibit 5-7
 Vehicle–Pedestrian Conflicts
 for One Crosswalk at
 Signalized Intersections

- Right turns on green (legal). These movements offer the highest potential for visibility between drivers and pedestrians, but drivers may occasionally fail to notice pedestrians crossing at the intersection.
- Left turns on green (legal for protected-permissive or permissive left-turn phasing). This represents a significant risk for pedestrians, as a driver undertaking a permissive left turn from the major street is primarily looking ahead for gaps in oncoming traffic and may not see pedestrians crossing the minor street.
- Right turns on red (legal in most of the United States and Canada). These have a moderate potential for severity due to the driver looking to the left for a gap and not seeing the pedestrian crossing in front of the stopped driver from the right. In some cases drivers turning right on red move into the crosswalk to improve their sight lines to the left and cause pedestrians to pass either in front or behind them.

Pedestrians at roundabouts, on the other hand, face two conflicting vehicular movements on each approach, as depicted in Exhibit 5-8:

- Conflict with entering vehicles and
- Conflict with exiting vehicles.

At conventional and roundabout intersections with multiple approach lanes, an additional conflict is added with each additional lane that a pedestrian must cross.

The direction conflicting vehicles will arrive from is more predictable for pedestrians at roundabouts.

Exhibit 5-8
Vehicle-Pedestrian Conflicts at Single-Lane Roundabouts

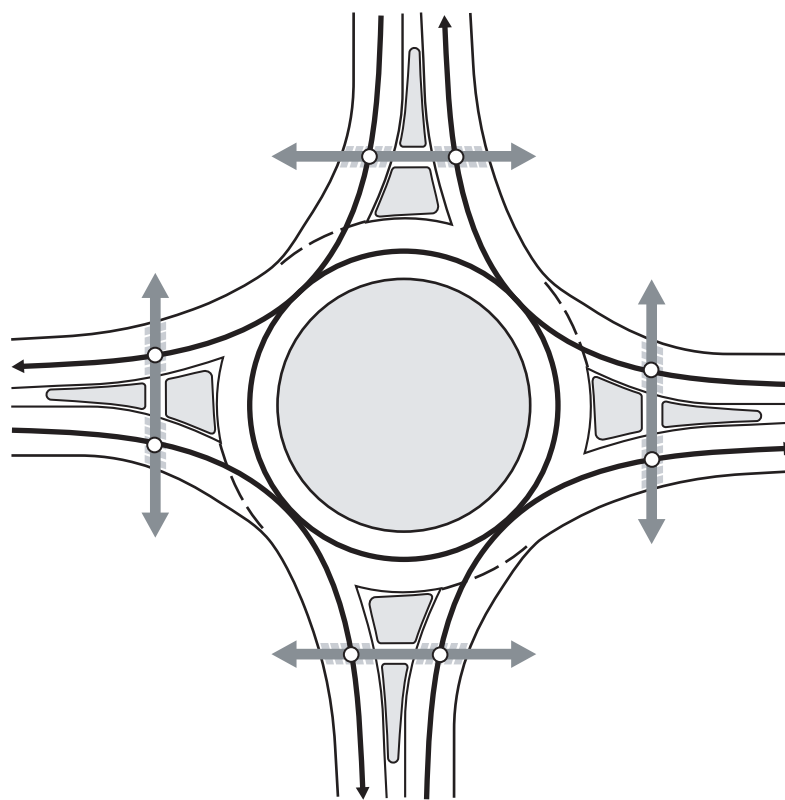

○ Vehicle/Pedestrian Conflicts

5.2.4 BICYCLE CONFLICTS

Bicyclists face similar conflicts as motor vehicles at both signalized intersections and roundabouts. However, because bicyclists typically ride on the right side of the road between intersections, they face additional conflicts when they need to merge into the flow of motor vehicle traffic or where motor vehicles cross their path. Conflicts unique to bicyclists occur on each approach to conventional four-leg intersections, and the typical vehicle–vehicle conflicts within the intersection can be more significant for bicyclists. The conflicts experienced by bicyclists vary widely depending on how they choose to negotiate the intersection:

- Many cyclists making through movements will continue to ride on the right side of the road as they enter a conventional intersection; this action results in a conflict point with motorists who are making right turns (the “right hook” crash type).
- Experienced cyclists often merge into the flow of motor vehicle traffic prior to entering the intersection, reducing the likelihood of right-hook crashes and making themselves more visible to other drivers at the intersection. This action results in a possible merging conflict point in advance of the intersection. Experienced cyclists prefer this conflict point because they are able to control the location and dynamics of the merge.
- Cyclists making vehicular-style left turns need to merge into other vehicle traffic and sometimes across travel lanes if there are multiple through travel lanes and/or a left-turn only lane. This maneuver results in at least one and possibly multiple merging conflicts.
- Some cyclists may choose to make pedestrian-style left turns on the roadway by riding straight through the intersection on the right side, stopping at the far corner, turning their bicycle 90° to the left, and traveling straight through as if they were coming from the right. These cyclists experience the typical vehicle–vehicle conflicts as well as two right-hook conflicts, one for each of their through movements.
- Some cyclists (typically children or less-experienced adult cyclists) choose to travel through intersections by using the sidewalks and crosswalks. These cyclists experience the same conflict points as described for pedestrians in Section 5.2.3. If these cyclists choose to ride their bikes through crosswalks, the probability of a crash is generally higher due to their speed and reduced ability to react to a possible conflict. These cyclists also experience potential conflicts with pedestrians on sidewalks or in crosswalks.

Similarly to conventional intersections, the conflicts experienced by bicyclists at roundabouts are dependent on how they choose to negotiate the roundabout. The primary issue is whether cyclists choose to travel through the roundabouts like other vehicles or like pedestrians. Some roundabouts include design features that make it easy for cyclists to make this choice.

If bicyclists travel through a roundabout as a vehicle, they experience several conflicts unique to bicyclists:

- A merging conflict occurs at the point where the bicyclist merges into the traffic stream.

At both conventional intersections and roundabouts, the type and number of conflicts experienced by bicyclists are dependent on how they choose to negotiate the intersection.

- At multilane roundabouts, it is recommended that cyclists travel through the roundabout in the same manner as other vehicles. Therefore, cyclists making left turns may encounter multiple merging conflicts as they change into a lane designated for left-turn movements.
- At roundabouts where a right-turn only lane or a right-turn bypass lane is present, cyclists making through movements or left-turn movements may also experience additional merging conflicts.
- Cyclists should not choose to travel on the outside part of the circulatory roadway, even at multilane roundabouts. However, some bicyclists may choose to ride in this position past a roundabout exit, where they face a potential conflict with exiting vehicles.
- When circulating at a roundabout, bicyclists are less visible and therefore more vulnerable to the merging and exiting conflicts that happen at multilane roundabouts. This is especially true if cyclists hug the curb as described above, because motorists further to the right are more out of the primary sight lines of entering drivers. In addition, since cyclists typically travel slightly slower than other vehicles in roundabouts, it is possible for motorists to pass cyclists and cut them off when exiting.
- As described above, bicyclists should make left turns in the same manner as vehicles. However, their slower speed makes it possible for motorists to pass them on the right, resulting in another possible conflict when left-turning bicyclists exit the roundabout.

Bicycle–pedestrian conflicts can also occur on sidewalks or shared use paths adjacent to the roundabout.

If bicyclists travel through a roundabout like pedestrians, then they experience the typical pedestrian–vehicle conflicts as described in Section 5.2.3 as well as several conflicts unique to bicyclists:

- A bicycle–pedestrian conflict occurs at the point where the bicyclist gets onto the sidewalk or shared-use path.
- On shared-use paths or on sidewalks at roundabouts, if bicyclists continue to ride, additional bicycle–pedestrian conflicts occur wherever bicycle and pedestrian movements cross.
- If bicyclists choose to ride their bikes through crosswalks, the probability of a crash is generally higher due to their speed and reduced ability to react to a possible conflict with vehicles.
- A merging conflict exists with other bicyclists and possibly motor vehicles at the point where the bicyclists reenter the roadway after traveling through the roundabout as a pedestrian.

5.3 OBSERVED SAFETY PERFORMANCE

This section summarizes the overall safety performance of roundabouts in the United States and the detailed collision types experienced. Pedestrian and bicycle crash statistics are discussed separately using international data.

5.3.1 COMPARISONS TO PREVIOUS INTERSECTION TREATMENT

The most up-to-date knowledge on the safety effects of roundabout conversions in the United States is summarized in *NCHRP Report 572 (2)*. Before-and-after conversion data were collected for 55 locations with variations in previous intersection treatment (two-way stop, all way stop, or signal control), environment (urban and rural), and number of circulating lanes.

Exhibit 5-9 presents the results of this study for both total and injury accidents, including the expected percent reduction and associated standard error. Injury accidents are defined as those involving definite injury or fatality. In other words, property damage only (PDO) and possible injury accidents (C on the KABCO scale) are not included. Results are shown separately for various logical groups for which sample sizes were large enough to facilitate a disaggregate analysis. The percent reduction can be applied to the expected crash frequency prior to conversion to estimate the expected crash frequency of a contemplated roundabout or the expected reduction in crashes following conversion.

Exhibit 5-9
Comparisons to Previous
Intersection Treatments in
the United States

Control Before	Sites	Setting	Lanes	Estimate of the Percent Reduction in Crashes (and Standard Error)	
				All	Injury + Fatal
All Sites	55	All	All	35.4% (3.4)	75.8% (3.2)
Signalized	9	All	All	47.8% (4.9)	77.7% (6.0)
	4	Suburban	2	66.7% (4.4)	Sample too small to analyze
	5	Urban	All	Effects insignificant	60.1% (11.6)
All-way stop	10	All	All	Effects insignificant	Effects insignificant
	36	All	All	44.2% (3.8)	81.8% (3.2)
	9	Rural	1	71.5% (4.0)	87.3% (3.4)
	17	All	All	29.0% (9.0)	81.2% (7.9)
Two-way stop	12	Urban	1	39.8% (10.1)	80.3% (10.0)
	5		2	Sample too small to analyze	Sample too small to analyze
	10		All	31.8% (6.7)	71.0% (8.3)
	4	Suburban	1	78.2% (5.7)	77.6% (10.4)
	6		2	19.3% (9.1)	68.0% (11.6)
	27	Urban/	All	30.8% (5.5)	74.4% (6.0)
	16	Suburban	1	56.3% (6.0)	77.7% (7.4)
11		2	17.9% (8.2)	71.8% (9.3)	

Overall, there is an observed reduction of 35% and 76% in total and injury crashes, respectively, following conversion to a roundabout. These values are consistent with results from international studies, as shown in Exhibit 5-10.

The findings of these studies all show that injury crashes are reduced more dramatically than crashes involving property damage only. This is in part due to the configuration of roundabouts, which eliminates severe crashes such as left-turn, head on, and right angle crashes. Other conclusions specifically drawn from the U.S. study (2) are as follows:

- *Control type before.* There are large and highly significant safety benefits of converting intersections with signals and two-way stop control to

 Roundabouts: An Informational Guide

Exhibit 5-10
Mean Crash Reduction
in Various Countries

Country	Mean Reduction (%)	
	All Crashes	Injury Crashes
Australia	41–61%	45–87%
France	-	57–78%
Germany	36%	-
Netherlands	47%	-
United Kingdom	-	25–39%
United States	35%	76%

Source: (7), France (8), U.S. (2)

roundabouts. The benefits are greater for injury crashes than for all crash types combined. For the conversions from all-way stop control there is no apparent safety effect.

- *Number of lanes.* The safety benefit is greater for single-lane roundabouts than for two-lane designs for urban and suburban roundabouts that were previously two-way stop-controlled.
- *Setting.* The safety benefits for rural installations, which were all single-lane, were greater than for urban and suburban single-lane roundabouts.
- *Additional insights.* Further analysis provided the following insights:
 - The safety benefit appears to decrease with increasing AADT, irrespective of control type before, number of lanes, and setting.
 - For various combinations of settings, control type before, and number of lanes for which there were sufficiently large samples, there was no apparent relationship to inscribed circle diameter or central island diameter.
 - The reduction in all types of crashes and injury crashes is particularly notable in rural environments where approach speeds are high.

5.3.2 CRASH TYPES

It is instructive for designers to examine details of crash types and location at roundabouts. Exhibit 5-11 shows the percentage of the main crash types found in U.S. data in an analysis of 39 roundabouts where detailed crash reports were reviewed (2). As can be seen from the exhibit, over half of the crashes are two-vehicle crashes involving entering or exiting the roundabout. Further distinction with entering–circulating and exiting–circulating crashes can be made between single-lane and multilane roundabouts. For single-lane roundabouts, 80% of these

Exhibit 5-11
Crash Types at U.S.
Roundabouts

Crash Type	Percent
Entering–Circulating	23
Exiting–Circulating	31
Rear-End on Leg	31
Loss of Control on Leg	13
Pedestrian	1
Bicycle	1

Source: (2)

two types of crashes were entering–circulating, with 20% exiting–circulating. However, for multilane roundabouts, the opposite type of crash is predominant: 64% were exiting–circulating, with 36% entering–circulating.

Additional data compiled by the IIHS (9) provides a summary of crash types at 29 single-lane roundabouts and 9 multilane roundabouts in Maryland. The study represents 149 crashes at the single-lane sites and 134 crashes at the multilane sites for which at least 2 years of data was available. Six of the single-lane roundabouts accounted for 59% of all crashes at single-lane roundabouts studied, and 2 roundabouts accounted for more than 80% of all crashes at the multilane roundabouts.

Crash-type results from the IIHS study are presented in Exhibit 5-12 along with international data for comparison. Exhibit 5-13 illustrates the crash types

Crash type	France	Queensland, Australia	United Kingdom ¹	United States	
				Single- Lane	Double- Lane
1. Failure to yield at entry (entering-circulating)	36.6%	50.8%	71.1%	13%	17%
2. Single-vehicle run off the circulatory roadway	16.3%	10.4%	8.2% ²	50% ²	28% ²
3. Single vehicle loss of control at entry	11.4%	5.2%	2	2	2
4. Rear-end at entry	7.4%	16.9%	7.0% ³	34%	19%
5. Circulating–exiting	5.9%	6.5%			4%
6. Pedestrian on crosswalk	5.9%		3.5% ⁴		4% ⁵
7. Single vehicle loss of control at exit	2.5%	2.6%	2		
8. Exiting–entering	2.5%			1%	
9. Rear-end in circulatory roadway	0.5%	1.2%			
10. Rear-end at exit	1.0%	0.2%			
11. Passing a bicycle at entry	1.0%				
12. Passing a bicycle at exit	1.0%				
13. Weaving in circulatory roadway	2.5%	2.0%			
14. Wrong direction in circulatory roadway	1.0%				
15. Pedestrian on circulatory roadway	3.5%		4		
16. Pedestrian at approach outside crosswalk	1.0%		4		
Other collision types		2.4%	10.2%	2%	3%
Other sideswipe crashes		1.6%			24% ⁶

Notes:

1. Data are for “small” roundabouts [curbed central islands >13 ft (4 m) diameter, relatively large ratio of inscribed circle diameter to central island size]
2. Reported findings do not distinguish among single-vehicle crashes.
3. Reported findings do not distinguish among approaching crashes.
4. Reported findings do not distinguish among pedestrian crashes.
5. Reported findings combine pedestrian and bicycle crashes.
6. Reported findings do not distinguish among sideswipe crashes.

Sources: France (10), Australia (11), United Kingdom (1), United States (2)

Exhibit 5-12
Comparison of Crash Types
at Roundabouts

Roundabouts: An Informational Guide

Exhibit 5-13
 Graphical Depiction of Crash
 Types at Roundabouts
 (Numbers correspond to
 those in Exhibit 5-12.)

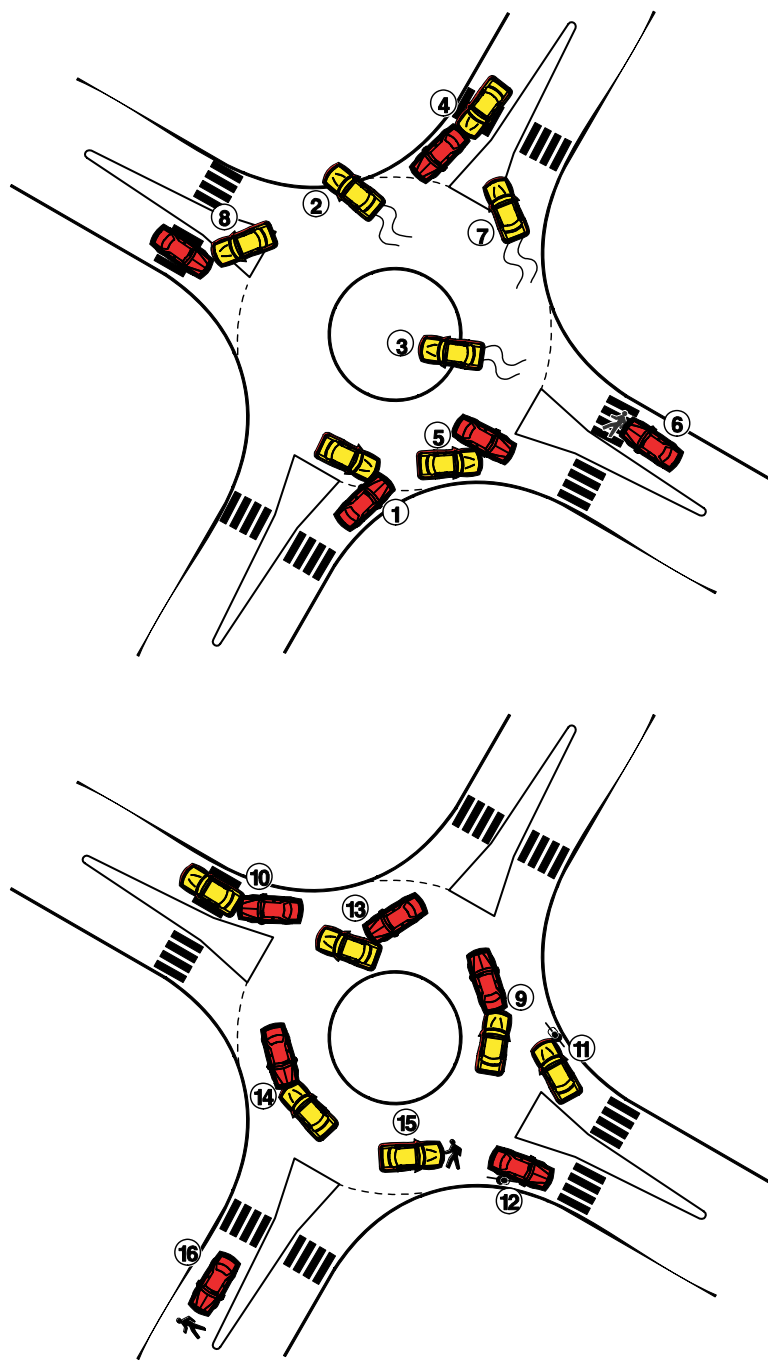

Source: (12)

identified in Exhibit 5-12. Exhibit 5-12 shows that a variety of distinctive crash types can take place at roundabouts. A designer should be aware of these crash types when making decisions about alignment and location of fixed objects. These crash types are suggested as conflict types for reporting crashes at roundabouts and conducting traffic conflict analysis.

5.3.3 PEDESTRIANS

As described previously, vehicular injury crashes normally decrease when roundabouts are installed at an existing intersection. The safety benefits of roundabouts have been found to carry over to pedestrians as well, as shown in the British statistics of Exhibit 5-14. This may be due to the reduced speeds at roundabouts as compared with the previous intersection forms.

Intersection Type	Pedestrian Crashes per Million Trips
Mini-roundabout	0.31
Conventional roundabout (older designs)	0.45
Flared roundabout (newer designs)	0.33
Signals	0.67

Source: (1, 14)

For pedestrians, the risk of being involved in a severe collision is lower at roundabouts than at other forms of intersections due to the slower vehicle speeds. Likewise, the number of conflict points for pedestrians is lower at roundabouts than at other intersections, which can lower the frequency of crashes. The splitter island between entry and exit also allows pedestrians to resolve conflicts with entering and exiting vehicles separately.

For pedestrians, speed plays a significant role in whether a vehicle–pedestrian crash will result in a fatality. Exhibit 5-15 shows that a pedestrian is about 8 times more likely to die when struck at 30 mph (50 km/h) than at 20 mph (32 km/h)—a difference of only 10 mph (13). Therefore, the difference in design speed is critical to all users who are not within the protective body of a motorized vehicle.

The minor additional delay or inconvenience to drivers of lower-speed roundabout designs (as compared to higher-speed roundabout designs) is a trade-off for the substantial safety benefit to pedestrians (and bicyclists). Older drivers may benefit from the additional time to perceive, think, react, and correct for errors (as may all users). It should be clarified that there has been no specific research performed on older drivers, older pedestrians, and older bicyclists at roundabouts. It should also be noted that visually impaired pedestrians are not provided the audible cues

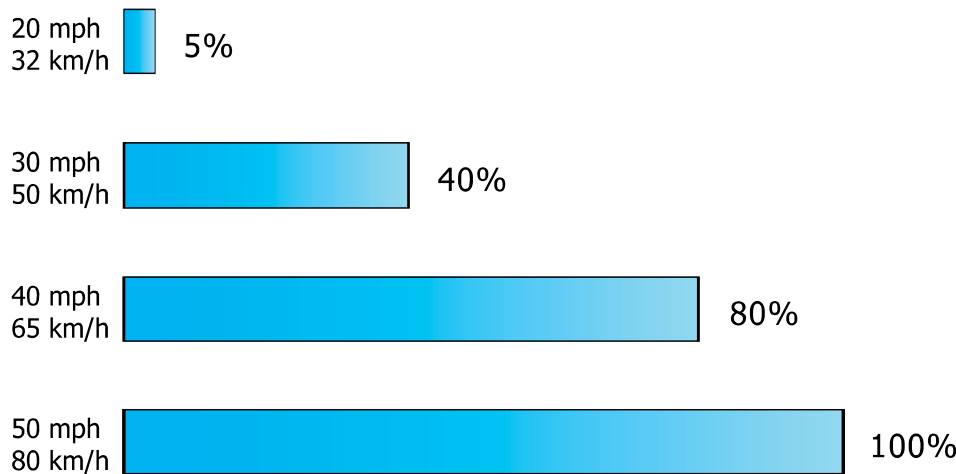

Source: (13)

Exhibit 5-14

British Crash Rates for Pedestrians at Roundabouts and Signalized Intersections

Exhibit 5-15

Chance of Pedestrian Death If Hit by a Motor Vehicle

from vehicle streams that are available at a signal-controlled intersection. For example, at roundabout exits it may be difficult to discern the sound of vehicles that will continue to circulate from those exiting the roundabout. Therefore, information needs to be provided to these users through various appropriate design features for them to safely locate and navigate the crossings at roundabouts.

A Dutch study of 181 intersections converted to roundabouts (4) found reductions of 73% in all pedestrian crashes and 89% in pedestrian injury crashes. In this study, all modes shared in the safety benefits to greater (passenger cars) or lesser extents (bicycles), as shown in Exhibit 5-16.

Exhibit 5-16
Percentage Reduction in the Number of Crashes by Mode in a Dutch Study

Mode	All Crashes	Injury Crashes
Passenger car	63	95
Moped	34	63
Bicycle	8	30
Pedestrian	73	89
Total	51	72

Source: (4)

A risk analysis of 59 roundabouts and 124 signalized intersections was carried out on crash data in Norway between 1985 and 1989. Altogether, 33 crashes involving personal injury were recorded at the 59 roundabouts. Only one of these crashes involved a pedestrian, compared with the signalized intersections where pedestrians were involved in 20% of the personal injury crashes (57 of 287 injury crashes) (15).

5.3.4 BICYCLISTS

Safety studies on bicyclists at roundabouts have mixed findings. As shown in Exhibit 5-17, in Britain, bicyclists fare worse in terms of crashes at roundabouts than at signalized intersections.

Bicyclists experience more problems at roundabouts than any other road user.

Exhibit 5-17
British Crash Rates for Bicycles and Motorcyclists at Roundabouts and Signalized Intersections

Intersection Type	Bicyclist Crashes per Million Trips	Motorcyclist Crashes per Million Trips
Mini-roundabout	3.11	2.37
Conventional roundabout	2.91	2.67
Flared roundabout	7.85	2.37
Signals	1.75	2.40

Source: (1, 14)

A French study (5) compared the crashes in 1988 in 15 towns in the west of France at signalized intersections and roundabouts, as shown in Exhibit 5-18. The conclusions from the analysis were:

- There were twice as many injury crashes per year at signalized intersections than at roundabouts.
- Two-wheel vehicles were involved in injury crashes more often (+77%) at signalized intersections than at roundabouts.
- People were more frequently killed and seriously injured per crash (+25%) at roundabouts than at signalized intersections.
- Proportionally, two-wheel vehicle users were more often involved in crashes (+16%) at roundabouts than at signalized intersections. Furthermore, the consequences of such crashes were more serious.

	Signalized Intersections	Roundabouts
Number of intersections	1238	179
Number of personal injuries	794	59
Number of crashes involving two-wheel vehicles	278	28
Personal injury crashes/year/intersection	0.64	0.33
Two-wheel vehicle crashes/year/intersection	0.23	0.13
Crashes to two-wheel vehicles per 100 crashes	35.0	40.7
Serious crashes/year/crossroad	0.14	0.089
Serious crashes to two-wheel vehicles/year/crossroad	0.06	0.045
Serious crashes/100 crashes	21.9	27.1
Serious crashes to two-wheel vehicles/100 crashes to a two-wheel vehicle	27.0	33.3

Source: (5)

All European countries report that a more careful design is necessary to enhance bicyclist safety. The type of bicycle crashes depends on the bicycle facilities provided at the roundabout. If there are no bicycle facilities, or if there is a bike lane on the outer area of the circulatory roadway, crashes typically occur between entering cars and circulating bicyclists as well as between exiting cars and bicyclists that are circulating around the outer edge of the circulatory roadway. Improperly placed signs on the splitter island may also be a contributing factor.

As a result, most European countries have policies:

- To avoid bike lanes on the outer edge of the circulatory roadway;
- To allow bicyclists to mix with vehicle traffic without any separate facility in the circulatory roadway when traffic volumes are low, on single lane roundabouts operating at lower speeds [e.g., up to 8,000 vehicles per day in the Netherlands (4)]; and
- To introduce separated bicycle facilities outside the circulatory roadway when vehicular and bicycle volumes are high. These separated bicycle facilities cross the exits and entries at least one car length from the edge of the circulatory roadway lane, adjacent to the pedestrian crossings. In some countries (e.g., Germany), bicyclists have priority over entering and exiting cars, especially in urban areas. Other countries (e.g., Netherlands) prefer to give priority to car traffic, showing a yield sign to bicyclists. The latter solution (i.e., separated bicycle facilities with vehicular traffic priority at the crossing points) is the standard solution for rural areas in most European countries.

Extrapolating European bicycling experience to the United States should be done with caution since drivers in Europe are more accustomed to interacting with bicyclists.

Speed is a fundamental risk factor in the safety of bicyclists. Typical on-road bicyclist speeds are in the range of 12 to 20 mph (20 to 30 km/h), and designs that constrain the speeds of vehicles to similar values will minimize the relative speeds and thereby improve safety. Design features that slow traffic are considered safe treatments for bicyclists (16). These may include tightening entry curvature and entry width and radial alignment of the legs of a roundabout, such as with the

Exhibit 5-18

A Comparison of Crashes in France between Signalized Intersections and Roundabouts

Typical European practice is to provide separated bicycle facilities outside the circulatory roadway when vehicular and bicycle volumes are high.

urban compact design. In addition, multilane roundabouts should not be used where they are not needed for capacity purposes in the short term, as single-lane roundabouts are much safer for bicyclists.

5.4 INTERSECTION-LEVEL CRASH PREDICTION METHODOLOGY

Intersection-level crash prediction models can be used to evaluate the safety performance of an existing roundabout relative to its peers and in the estimation of the expected safety changes if a roundabout is contemplated for construction at an existing, conventional intersection. *A key proviso is a requirement that the models can be assumed as representative of the pertinent jurisdiction or can be recalibrated using data representative of that jurisdiction.*

For an existing roundabout, the safety-performance estimate can be used in a network screening process to examine the performance of that roundabout in relation to other roundabouts or other intersections. For roundabouts performing below par from a safety perspective, diagnostic procedures can be used to isolate any problems and develop corrective measures.

The methodology provides a means to combine model predictions and observed accident frequencies into a single, refined estimate of the expected crash frequency so that the observed crash history of a site can be considered in the estimation process. This empirical Bayes (EB) methodology recognizes that the observed crash frequency, by itself, is a poor estimate of safety performance due to the randomness of crash counts.

Intersection-level models for roundabouts in the United States are documented in *NCHRP Report 572 (2)* and shown in Exhibit 5-19 and Exhibit 5-20. The dispersion parameter in these tables was estimated in the model calibration process and is used in the EB methodology as illustrated below.

5.4.1 METHODOLOGY TO EVALUATE THE SAFETY PERFORMANCE OF AN EXISTING ROUNDABOUT

Step 1: Assemble data, including the number of approaches, number of circulating lanes, and the count of total and KAB injury crashes (i.e., excluding possible injury crashes) for the roundabout of interest for a period of n years (up to 10 years). For the same time period, obtain or estimate a total entering AADT representative of that time period.

Step 2: Select the appropriate roundabout level model from Exhibit 5-19 or Exhibit 5-20 and use to estimate the annual number of crashes (P) that would be expected at roundabouts with traffic volumes and other characteristics similar to the one being evaluated.

If the selected model can be assumed to represent the jurisdiction, it can be used directly.

If, as may be more likely the case, the model cannot be assumed to represent the jurisdiction, a calibration multiplier must first be estimated using data (similar

Model for Predicting the Expected Total Crash Frequency per Year by Number of Approaches			
Circ. Lanes	3 Legs	4 Legs	5 Legs
1	0.0011(AADT) ^{0.7490} 4,000 to 31,000 AADT	0.0023(AADT) ^{0.7490} 4,000 to 37,000 AADT	0.0049(AADT) ^{0.7490} 4,000 to 18,000 AADT
2	0.0018(AADT) ^{0.7490} 3,000 to 20,000 AADT	0.0038(AADT) ^{0.7490} 2,000 to 35,000 AADT	0.0073(AADT) ^{0.7490} 2,000 to 52,000 AADT
3 or 4 ¹	Not Available	0.0126(AADT) ^{0.7490} 25,000 to 59,000 AADT	Not Available

Dispersion parameter: k = 0.90

Notes: Circ. = circulating; AADT is the total entering AADT; the AADT range for the calibration data is also shown.

¹ Models based on a small sample size of roundabouts that appeared to have high crash frequencies and should be used with caution

Model for Predicting the Expected KAB Injury Crash Frequency per Year by Number of Approaches			
Circ. Lanes	3 Legs	4 Legs	5 Legs
1 or 2	0.0008(AADT) ^{0.5923} 3,000 to 31,000 AADT	0.0013(AADT) ^{0.5923} 2,000 to 37,000 AADT	0.0029(AADT) ^{0.5923} 2,000 to 52,000 AADT
3 or 4 ¹	Not Available	0.0119(AADT) ^{0.5923} 25,000 to 59,000 AADT	Not Available

Dispersion parameter: k = 0.946

Notes: Circ. = circulating; AADT is the total entering AADT; the AADT range for the calibration data is also shown.

¹ Models based on a small sample size of roundabouts that appeared to have high crash frequencies and should be used with caution

Exhibit 5-19
Intersection-Level Safety Performance Models and Validity Ranges—Total Crashes

Exhibit 5-20
Intersection-Level Safety Performance Models and Validity Ranges—KAB Injury Crashes

to data acquired in Step 1) from a sample of roundabouts representative of ones in that jurisdiction. At a minimum, a dataset for at least 10 roundabouts with a minimum of 50 crashes is needed. The recalibration multiplier is the sum of crashes recorded in this dataset divided by the sum of the crashes predicted by the model for this dataset. The model from Exhibit 5-19 or Exhibit 5-20 is then applied with the recalibration multiplier to estimate the annual number of crashes (*P*).

Step 3: Combine the model estimate (*P*) with the count of crashes (*x*) in the *n* years of observed data to obtain an estimate of the expected *annual* number of crashes (*m*) at the roundabout. This estimate of *m* is calculated as:

$$m = w_1x + w_2P$$

$$w_1 = \frac{P}{(1/k) + nP}$$

Equation 5-1

Equation 5-2

Equation 5-3

$$w_2 = \frac{(1/k)}{(1/k) + nP}$$

where

m = expected annual crash frequency;

x = total crashes observed;

P = predicted annual number of crashes;

n = years of observed data; and

k = dispersion parameter for a given model (given in Exhibit 5-19 or Exhibit 5-20).

Estimates can be obtained for crashes of all severities combined (total crashes) or for KAB-injury crashes only.

5.4.2 APPLICATION TO NETWORK SCREENING

In network screening, the refined safety performance estimate, m , can be used to assess how well an existing roundabout is performing relative to other similar roundabouts or to intersections of other types. Comparisons may be made to the average expected crash frequency of a collection of other sites or to specific sites. If the other site(s) are also roundabouts, the appropriate models would be selected from Exhibit 5-19 or Exhibit 5-20 and recalibrated if necessary. If the other sites are other intersection types, then similar models specific to those site types need to be assembled. Many jurisdictions may have calibrated their own models for other intersection types; otherwise, models from other sources may be adapted by estimating a recalibration multiplier using the procedure outlined in Section 5.4.2.1. More detailed information on network screening methods is available in the HSM and in the documentation for FHWA's *SafetyAnalyst* software (17).

5.4.2.1 Comparison to the Average Expected Crash Frequency of Similar Roundabouts

Comparing the expected crash frequency of a particular roundabout to the average expected frequency involves comparing that site's EB estimate to the model estimate for roundabouts with similar numbers of approaches and circulating lanes. For instance, from Exhibit 5-21 an analyst could conclude that the safety performance for that roundabout is worse than that for similar roundabouts since its expected crash frequency, 3.94, is larger than the model estimate for similar roundabouts, 3.39.

5.4.2.2 Comparison to Other Specific Sites

This comparison involves comparing the site's EB estimate to the EB estimate for the other sites. These sites could be roundabouts or all intersections in a jurisdiction (other roundabouts and other conventional intersections). A useful application of these estimates is to rank sites in descending order of the EB estimate of the expected crash frequency to prioritize the sites for a more detailed investigation of safety performance. An alternative method is to rank sites by the difference between the EB estimate and the prediction model estimate.

Using Exhibit 5-21, the ranking measures described above would provide the following results: (1) for the first method, a value of 3.94 would be used, or (2) for the second method, a value of $(3.94 - 3.39 = 0.55)$ would be used.

Example: Calculation of Total Crashes

Input parameters

- Number of approaches = 4
- Number of circulating lanes = 1
- Years of observed data = $n = 3$
- Total crashes observed = $x = 12$
- Total entering AADT = 17,000

Step 1:

The appropriate safety performance model and dispersion parameter k from Exhibit 5-19, given 4 approaches and 1 circulating lane, are as follows:

$$\text{Total crashes/year} = 0.0023(\text{AADT})^{0.7490}, k = 0.8986$$

Assume, for illustration purposes, that this model is representative of intersections in the jurisdiction and that no recalibration is necessary. The estimate of P is then:

$$P = 0.0023(17,000)^{0.7490} = 3.39 \text{ crashes/yr}$$

Step 2:

Calculate the weights and the estimate of m , the expected annual crash frequency:

$$w_1 = \frac{P}{(1/k) + nP} = \frac{3.39}{(1/0.8986) + 3 \times 3.39} = 0.30$$

$$w_2 = \frac{(1/k)}{(1/k) + nP} = \frac{(1/0.8986)}{(1/0.8986) + 3 \times 3.39} = 0.10$$

$$m = w_1x + w_2P = 0.30 \times 12 + 0.10 \times 3.39 = 3.94 \text{ crashes/year}$$

Discussion

The prediction model estimate of 3.39 has been refined to an empirical Bayes estimate of 3.94 after consideration of the observed annual crash frequency of 12 crashes in 3 years, of which 4 involve KAB injuries. Likewise, the observed frequency of $12/3 = 4$ crashes per year has been refined to a slightly lower value.

Exhibit 5-21
Calculation of Total Crashes

These measures can be calculated for total crashes and for injury crashes and, from the differences between the two estimates, for non-injury crashes. A severity-weighted ranking measure can be derived by applying weights to injury and non-injury crashes that reflect their relative severity. (In estimating a severity ranking measure for the second method, a negative difference in crash frequency is converted to a value of zero.)

Thus, continuing from Exhibit 5-21, using the EB weights on their own, the appropriate safety performance model and dispersion parameter k from Exhibit 5-20, given four approaches and one circulating lane, for injury crashes are as shown in Exhibit 5-22.

5.4.3 ESTIMATING THE SAFETY BENEFIT OF A CONTEMPLATED CONVERSION OF AN EXISTING INTERSECTION TO A ROUNDABOUT

The objective of this procedure is to provide designers and planners with a tool to estimate the change in crash frequency expected with the installation of a roundabout at an existing controlled intersection.

Exhibit 5-22
Calculation of Injury Crashes

Example: Calculation of Injury Crashes

Input parameters

Same as Exhibit 5-21, plus:
Total injury crashes observed = $x = 4$

Step 1:

The appropriate safety performance model and dispersion parameter k from Exhibit 5-20, given 4 approaches and 1 circulating lane, are as follows:

$$\text{Injury crashes/year} = 0.0013(\text{AADT})^{0.5923}, k = 0.9459$$

Assume, for illustration purposes, that this model is representative of intersections in the jurisdiction and that no recalibration is necessary. The estimate of P is then:

$$P = 0.0013(17,000)^{0.5923} = 0.42 \text{ injury crashes/yr}$$

Step 2:

Calculate the weights and the estimate of m , the expected annual crash frequency:

$$w_1 = \frac{P}{\frac{1}{k} + nP} = \frac{0.42}{\frac{1}{0.9459} + 3 \times 0.42} = 0.18$$

$$w_2 = \frac{\frac{1}{k}}{\frac{1}{k} + nP} = \frac{\frac{1}{0.9459}}{\frac{1}{0.9459} + 3 \times 0.42} = 0.46$$

$$m = w_1x + w_2P = 0.18 \times 4 + 0.46 \times 0.42 = 0.91 \text{ crashes/year}$$

Step 3:

Next, the expected non-KAB crash frequency is estimated and the severity weight considered. For the example, consider that the relative weights are 1.0 for non-KAB crashes and 10.0 for KAB crashes.

$$\text{Non-KAB crashes/year} = \text{total crashes/yr} - \text{injury crashes/yr} = 3.94 - 0.91 = 3.03$$

$$\text{Severity weighted estimate} = 3.03(1.0) + 0.91(10.0) = 12.13$$

Discussion

This value would be used for ranking with the first method.

A safety performance model representative of the *existing* intersection is required. This, again, will require that one exist for the jurisdiction or that data are available to enable a recalibration of a model calibrated for another jurisdiction using the procedure outlined earlier. The model for the existing intersection would be used, along with the intersection's crash history, in the empirical Bayes procedure to estimate *the expected crash frequency with the status quo in place*. This EB estimate would then be compared to *the expected frequency should a roundabout be constructed* to estimate the benefit of converting the intersection to a roundabout.

The expected frequency should a roundabout be constructed is estimated from an intersection-level model. As before, this requires that it be possible to recalibrate intersection-level models or that existing models be deemed adequate for the jurisdiction. Where there is no applicable intersection-level model for the jurisdic-

tion, an alternate approach can be used. In this, the results of the before–after study presented in Exhibit 5-9 can be applied as accident modification factors (AMFs) to *the expected crash frequency with the status quo in place* to find the expected benefit. More details on this alternate approach are provided in the HSM.

The first approach is preferred to the alternate and is most convenient because a comprehensive set of accident modification factors for a large number of conditions, including AADT levels, which would be required for properly applying the second approach, is not likely to be available.

5.4.3.1 Overview of the Recommended Approach

This example assumes that a stop-controlled intersection is being considered for conversion to a roundabout.

Step 1: Assemble data and accident prediction models for stop-controlled intersections and roundabouts.

1. For the past 5 years (if possible), obtain the count of total and injury crashes for the stop-controlled intersection under review.
2. For the same period, obtain or estimate the average total entering AADTs.
3. Estimate the average annual entering AADTs that would prevail for the period immediately after the roundabout is installed.
4. Assemble required crash prediction models for stop-controlled intersections and roundabouts for both total crashes and for KAB injury crashes. If the models cannot be assumed to be representative of the jurisdiction, a calibration multiplier must first be estimated using data from a sample of roundabouts representative of that jurisdiction and the procedure outlined earlier

Step 2: Use the EB procedure documented in Section 5.4.1 with the data from Step 1 and the *stop-controlled intersection model* to estimate the expected annual number of total and KAB injury crashes that would occur without conversion (i.e., had the intersection remained stop-controlled). The EB estimate for non-KAB crashes is then derived as the EB estimate for total crashes, minus the EB estimate for injury crashes.

Step 3: Use the appropriate *intersection-level model* from Exhibit 5-19 or Exhibit 5-20 and the AADTs from Step 1 to estimate the expected number of total and injury crashes that would occur if the intersection were converted to a roundabout. The estimate for non-KAB crashes is then derived as the model estimate for the total minus the model estimate for injury.

Step 4: Obtain, for KAB injury and non-KAB crashes, the difference between the stop-controlled EB estimate from Step 2 and the intersection-level model estimates from Step 3.

Step 5: Applying suitable dollar values for KAB injury and non-KAB crashes to the estimates from Step 4, obtain the estimated net safety benefit of converting the intersection to a roundabout. A useful source of these dollar values is FHWA's crash cost estimates (18).

Step 6: Compare estimated net safety benefit from Step 5 against the annualized roundabout conversion costs, considering other impacts if desired, and using conventional economic analysis tools. How and whether this is done is very jurisdiction-specific. Conventional methods of economic analysis can be applied after obtaining estimates of the economic values of changes in delay, fuel consumption, and other impacts. The results of the analysis above may indicate that roundabout conversion is justified based on a consideration of safety benefits. This result may be considered in context with other factors such as the following:

- Other improvement measures at the existing intersection may be more cost effective.
- Other impacts (delay, fuel consumption, etc.) may need to be assessed.
- In a system context, other locations may be more deserving of a roundabout. In other words, the results of the above analysis should be considered in the context of a more comprehensive, system-wide safety resource allocation process.

See Exhibit 5-23 for an example calculating the expected change in crashes when converting an intersection to a roundabout.

5.5 APPROACH-LEVEL CRASH PREDICTION METHODOLOGY

At the approach level, models are used for separately predicting three crash types (entering–circulating, exiting–circulating, and approach crashes) as a function of AADT and design characteristics. A range of alternative models are available depending on the design features of interest.

Entering–circulating crashes are computed using Equation 5-4.

Equation 5-4
$$\text{Crashes/year} = a_0 (\text{EnteringAADT})^{a_1} (\text{CircAADT})^{a_2} e^{[b_1(\text{Var1}) + \dots + b_5(\text{Var5})]}$$

where parameters are defined in Exhibit 5-24.

Exit-circulating crashes are computed using Equation 5-5.

Equation 5-5
$$\text{Crashes/year} = a_0 (\text{ExitingAADT})^{a_1} (\text{CircAADT})^{a_2} e^{[b_1(\text{Var1}) + \dots + b_5(\text{Var5})]}$$

where parameters are defined in Exhibit 5-25.

Approach crashes are computed using Equation 5-6.

Equation 5-6
$$\text{Crashes/year} = a_0 (\text{EnteringAADT})^{a_1} e^{[b_1(\text{ApproachHalfWidth})]}$$

where parameters are defined in Exhibit 5-26.

These models can be used for evaluating the safety at the approach level of existing roundabouts or alternative roundabout design options. There are two possibilities for application in this context:

1. *Direct application for an existing roundabout:* In this the model is used directly by substituting values of AADT and design characteristics to

Example: Calculation of Expected Change in Crashes Converting an Intersection to a Roundabout

Consider the data for the roundabout in Exhibit 5-21. Prior to being converted to a single-lane roundabout, this site was a four-leg, two-way stop-controlled intersection in an urban environment. Assume for purposes of this illustration that at the time the roundabout was constructed the decision of whether to convert this site into a roundabout had to be made. This example provides some calculation that could have been used to inform that decision.

At that time prior to the decision, there were 3 years of data with 17 observed crashes during this 3-year period, 10 of which had injuries. The average total entering AADT during this same time period was 16,000 vehicles per day. It was anticipated that the traffic volumes would increase to 17,000 vehicles per day by the time the proposed conversion would take place.

Recommended Approach

This procedure assumes that suitable intersection-level models are available. If this is not the case, then the alternate approach discussed below should be used. For convenience, some steps in the overview are combined using letters rather than numbers.

Step A:

NCHRP Report 572 provides default models for safety prediction at conventional intersections for comparison to roundabouts. Models for urban, four-leg, two-way-stop-controlled intersections [Refer to Table 27 in *NCHRP Report 572 (2)*] can be used in the EB procedure to predict the expected annual number of crashes, m , if the conversion to a roundabout was not undertaken.

Assuming that the models are representative of the jurisdiction and don't need recalibration, they are used to predict the annual number of crashes by severity for intersections with the same characteristics as the one under consideration:

$$\text{Total crashes/yr} = (\exp(-1.62))(AADT)^{0.220}, k = 0.45$$

$$= (\exp(-1.62))(16000)^{0.220} = 1.66$$

$$\text{Injury crashes/yr} = (\exp(-3.04))(AADT)^{0.220}, k = 0.45$$

$$= (\exp(-3.04))(16000)^{0.220} = 0.40$$

Next, the weights and EB estimate are calculated as before:

- Total Crashes:

$$w_1 = \frac{P}{(1/k) + nP} = \frac{1.66}{(1/0.45) + 3 \times 1.66} = 0.23$$

$$w_2 = \frac{(1/k)}{(1/k) + nP} = \frac{(1/0.45)}{(1/0.45) + 3 \times 1.66} = 0.31$$

$$m = w_1x + w_2P = 0.23 \times 17 + 0.31 \times 1.66 = 4.42 \text{ total crashes/year}$$

- Injury Crashes:

$$w_1 = \frac{P}{(1/k) + nP} = \frac{0.40}{(1/0.45) + 3 \times 0.40} = 0.12$$

$$w_2 = \frac{(1/k)}{(1/k) + nP} = \frac{(1/0.45)}{(1/0.45) + 3 \times 0.40} = 0.65$$

$$m = w_1x + w_2P = 0.12 \times 10 + 0.65 \times 1.66 = 2.28 \text{ injury crashes/year}$$

Because volumes are expected to increase in the after period, albeit only slightly, an adjustment is made to m to account for this change. This adjustment factor is calculated as:

$$(AADT \text{ after})^{0.220} / (AADT \text{ before})^{0.220} = (17000)^{0.220} / (16000)^{0.220} = 1.01$$

The adjusted m , using this factor is now equal to:

- $4.42 \times 1.01 = 4.46$ for total crashes
- $2.28 \times 1.01 = 2.30$ for injury crashes

In summary, the expected number of annual crashes by severity at the site if a conversion *does not* take place is estimated to be 4.46 total and 2.30 injury crashes per year.

Exhibit 5-23

Calculation of Expected Change in Crashes Converting an Intersection to a Roundabout

Roundabouts: An Informational Guide

Exhibit 5-23 (cont.)
 Calculation of Expected
 Change in Crashes
 Converting an Intersection
 to a Roundabout

Example: Calculation of Expected Change in Crashes Converting an Intersection to a Roundabout (cont.)

Step B:

The intersection-level roundabout model is used to predict the annual number of crashes should the intersection be converted to a roundabout. In this case, it is assumed for the convenience of this illustration that the default models from Exhibit 5-19 and Exhibit 5-20 were deemed adequate and need not be recalibrated for the jurisdiction. The AADT used is that expected with the roundabout in place (i.e., 17000).

- Total crashes/yr = $0.0023(\text{AADT})^{0.7490} = 0.0023(17000)^{0.7490} = 3.39$
- Injury crashes/yr = $0.0013(\text{AADT})^{0.5923} = 0.0013(17000)^{0.5923} = 0.42$

The expected number of annual crashes by severity at the site if a conversion *does* take place is 3.39 total and 0.42 injury crashes per year.

Step C:

Expected changes in crashes are calculated as follows:

- Total crashes: $3.39 - 4.46 = -1.07$ total crashes per year, or a 24% reduction.
- Injury crashes: $0.42 - 2.30 = -1.88$ injury crashes per year, or a 82% reduction.
- Non-KAB crashes: $2.97 - 2.16 = +0.81$ non-KAB crashes per year, or a 38% increase.

Estimated costs of crashes can be applied to calculate the equivalent monetary crash benefits. The FHWA report on crash cost estimates (18) provides the following costs for urban, stop-controlled intersection crashes for injury (KAB on KABCO scale) and non-KAB (CO on the KABCO scale) irrespective of intersection or crash type:

- Cost of non-KAB = \$15,953
- Cost of injury = \$297,561

Applying the FHWA unit costs, the annual economic benefit in crash savings is estimated as follows:

- Annual Economic Benefit = $1.88(\$297,561) - 0.81(15,953) = \$546,493$

Alternate Approach

For use when suitable intersection-level roundabout models are not available.

Step A:

This step is the same as Step A in the recommended approach. The expected number of annual accidents by severity at the site if a conversion *does not* take place is estimated to be 4.46 total and 2.30 injury accidents.

Step B:

From Exhibit 5-9, the percent reduction for an urban, two-way stop-controlled intersection converted to a single-lane roundabout is 39.8% for total accidents and 80.3% for injury accidents. The estimated reduction in accidents per year after conversion is:

- Total accidents/yr: $4.46 * (39.8/100) = 1.78$
- Injury accidents/yr: $2.30 * (80.3/100) = 1.85$

Step C:

The expected reduction in PDO accidents is equal to $1.78 - 1.85 = -0.07$ PDO accidents per year, or a 7% increase. Applying the FHWA unit costs, the annual economic benefit in accident savings is estimated as:

- Annual Economic Benefit = $1.85(\$297,561) - 0.07(15,953) = \$549,371$

Discussion

The difference between the results using the preferred and the alternate approach is due to the fact that the alternate approach employs accident reduction percentages that may not be representative of the situation under consideration. Specifically, the alternate approach uses an AMF that is by necessity based on an amalgamation of results from many sites with varying AADT, while the preferred method in effect applies an AMF that varies with AADT.

Model No.	Multiplier a_0	Entering AADT a_1	Circ. AADT a_2	Entry Radius (ft) b_1	Entry Width (ft) b_2	Central Island Diameter (ft) b_3	Angle To Next Leg (deg) b_4	1/Entry Path Radius (1/ft) b_5
1	0.00000176	1.0585	0.3672	—	—	—	—	—
2	0.00000216	0.9771	0.3088	0.0099	—	—	—	—
3	0.00000474	0.9217	0.2900	—	0.0582	-0.0076	—	—
4	0.00000213	1.0048	0.3142	0.0103	—	-0.0046	—	—
5	0.00015668	0.9499	0.2687	0.0105	—	—	-0.0425	—
6	0.00073488	0.7018	0.1321	—	0.0511	—	-0.0276	—
7	0.00012735	0.8322	0.1370	—	—	—	—	138.096

(Shaded row indicates preferred model.)

Model No.	Multiplier a_0	Exiting AADT a_1	Circ. AADT a_2	Inscribed Circle Diameter (ft) b_1	Central Island Diameter (ft) b_2	Circ. Width (ft) b_3	1/Circ. Path Radius (1/ft) b_4	1/Exit Path Radius (1/ft) b_5
1	0.00044631	0.3413	0.5172	—	—	—	—	—
2	0.00000846	0.2801	0.2530	0.0222	—	0.1107	—	—
3	0.00001308	0.3227	0.3242	—	0.0137	0.1458	—	—
4	0.02215926	0.2413	0.5626	—	—	—	372.8710	—
5	0.00005363	0.6005	0.7471	—	—	—	—	-387.729

(Shaded row indicates preferred model.)

Model No.	Multiplier a_0	Entering AADT a_1	Approach Half-Width (ft.) b_1
1	0.0034961	0.6036	—
2	0.0057838	0.4613	0.0301

(Shaded row indicates preferred model.)

Exhibit 5-24

Entering–Circulating Models

Exhibit 5-25

Exiting–Circulating Models

Exhibit 5-26

Approach Models

evaluate the safety performance of an existing roundabout with respect to the three crash types.

2. *Application for a roundabout being designed or redesigned:* In this, similar in principle to the predictive methodologies in the HSM and the Interactive Highway Safety Design Model (IHSDM), models with AADT as the only variable (Model 1 in Exhibit 5-24, Exhibit 5-25, and Exhibit 5-26) are considered as base models for average design conditions, and AMFs are applied for design features that are different from average conditions. Coefficients from models that include design variables are used in developing these AMFs.

Details of these applications are provided below.

5.5.1 EVALUATION OF APPROACH-LEVEL SAFETY PERFORMANCE

While the approach-level models have been developed to assist with design decisions, they can also be used in an EB procedure to estimate the expected safety performance at an approach or a number of approaches to an existing roundabout, *provided as before that the models can be assumed as representative of the pertinent jurisdiction or can be recalibrated using representative data from that jurisdiction.* This would be used to compare the safety performance of the subject roundabout approach to that of other similar approaches. For entities performing below par

from a safety perspective, diagnostic procedures can then be used to isolate any problems and to develop corrective measures.

The application of the EB method at the approach level would be identical to the procedure presented and illustrated earlier for the intersection level in Section 5.4. The models to be used would be those indicated by the shaded rows of Exhibit 5-24, Exhibit 5-25, and Exhibit 5-26.

5.5.2 CONSIDERATION OF APPROACH-LEVEL MODEL RESULTS FOR HSM-TYPE APPLICATION

The HSM documents an accident prediction algorithm that enables the number of total intersection-related accidents per year to be estimated using Equation 5-7:

$$\text{Equation 5-7} \quad N_{int} = N_b (AMF_1 \times AMF_2 \times \dots \times AMF_n)$$

where

N_{int} = predicted number of total intersection-related crashes per year after application of accident modification factors;

N_b = predicted number of total intersection-related crashes per year for base conditions; and

AMF_i = accident modification factors (AMF) ($i = 1$ to n) for various intersection features different from base conditions.

Each AMF is adjusted for observed features different from base conditions using Equation 5-8:

$$\text{Equation 5-8} \quad AMF_i = AMF_{base}^{(x-x_{base})}$$

where

AMF_i = accident modification factors (AMF) ($i = 1$ to n) for various intersection features different from base conditions,

AMF_{base} = AMF computed for the base condition value (see Exhibit 5-27),

x = observed value for the variable, and

x_{base} = base condition value for the variable (see Exhibit 5-27).

For the HSM, base condition models and AMFs are provided for conventional stop- and signal-controlled intersections. A panel of experts selected the AMFs after a review of relevant research findings, including calibrated prediction models, the estimated coefficients of geometric variables in these models, and the results of before–after safety evaluation studies.

A similar methodology can be considered for roundabouts at the approach level. For this potential application, Model 1 (with AADT as the only variable) in Exhibit 5-24 is considered as the base model. And, as noted above, the estimated coefficients for geometric features in the approach-level models can be considered in developing AMFs. The AMFs directly related to geometric variables and base condition values for these variables are shown in Exhibit 5-27.

Using the above equation, the effect of a design change can be identified by applying the appropriate AMF. However, caution is advised because many of the variables are correlated, resulting in model-implied effects that may not reflect

Variable	Base Condition Value	Entering–Circulating AMF	Exiting–Circulating AMF	Approach AMF
Entry Radius	76 ft	1.010		
Entry Width	20 ft	1.052		
Approach Half Width	18 ft			1.031
Inscribed Circle Diameter	134 ft		1.022	
Central Island Diameter	69 ft	0.992	1.014	
Circulating Width	23 ft		1.117	
Angle To Next Leg	93 deg	0.973		

reality. The correlation matrix provided as Table 3-14 of the *NCHRP Report 572 (2)* should therefore be considered before vetting these AMFs for formal application.

See Exhibit 5-28 for an example of the calculation of entering–circulating crashes using AMFs.

Exhibit 5-27

Base Conditions for Design Variables and AMFs Implied for Unit Change in Variables

Example: Calculation of Expected Frequency of Entering–Circulating Crashes Using AMFs

Consider the following roundabout leg for which the expected frequency of entering–circulating accidents is desired. The actual measurements for each relevant base condition variable and the corresponding AMFs for the site are as follows:

Input parameters

$$\text{Entry radius} = 30 \text{ ft}$$

$$\text{Entry width} = 12 \text{ ft}$$

$$\text{Central island diameter} = 80 \text{ ft}$$

$$\text{Angle to next leg} = 90^\circ$$

$$\text{Entering AADT} = 3,870 \text{ veh/day}$$

$$\text{Circulating AADT} = 1,200 \text{ veh/day}$$

Step 1: Apply the base prediction model form

Using Model 1 (with AADT as the only variable), use Equation 5-4 and Exhibit 5-24 as follows:

$$\begin{aligned} \text{Crashes/year} &= a_0 (\text{Entering AADT})^{a_1} (\text{Circ AADT})^{a_2} e^{[b_1(\text{Var1}) + \dots + b_5(\text{Var5})]} \\ &= 0.00000176(3870)^{1.0585} (1200)^{0.3672} = 0.15 \end{aligned}$$

Step 2: Calculate AMFs

$$\text{Entry radius: AMF} = 1.01^{(30-76)} = 0.63$$

$$\text{Entry width: AMF} = 1.052^{(12-20)} = 0.67$$

$$\text{Central island diameter: AMF} = 0.992^{(80-69)} = 0.92$$

$$\text{Angle to next leg: AMF} = 0.973^{(90-93)} = 1.09$$

Step 3: Apply the AMFs to the base model estimate

$$\text{Final prediction of crashes per year} = 0.15 * 0.63 * 0.67 * 0.92 * 1.09 = 0.06$$

Discussion

Increasing vehicle path curvature decreases relative speeds between entering and circulating vehicles, but also increases side friction between adjacent traffic streams in multilane roundabouts.

Exhibit 5-28

Calculation of Expected Frequency of Entering–Circulating Crashes Using AMFs

5.6 REFERENCES

1. Maycock, G. and Hall R. D. *Crashes at Four-Arm Roundabouts*. TRRL Laboratory Report LR 1120. Transport and Road Research Laboratory, Crowthorne, England, 1984.
2. Rodegerdts, L., M. Blogg, E. Wemple, E. Myers, M. Kyte, M. Dixon, G. List, A. Flannery, R. Troutbeck, W. Brilon, N. Wu, B. Persaud, C. Lyon, D. Harkey, and D. Carter. *NCHRP Report 572: Roundabouts in the United States*. Transportation Research Board of the National Academies, Washington, D.C., 2007.
3. Brilon, W. and B. Stuwe. "Capacity and Design of Traffic Circles in Germany." In *Transportation Research Record 1398*. TRB, National Research Council, Washington, D.C., 1993.
4. Schoon, C. C. and J. van Minnen. "Accidents on Roundabouts: II. Second Study into the Road Hazard Presented by Roundabouts, Particularly with Regard to Cyclists and Moped Riders." R-93-16. SWOV Institute for Road Safety Research in the Netherlands, 1993.
5. Alphand, F., U. Noelle, and B. Guichet. "Roundabouts and Road Safety: State of the Art in France." In *Intersections without Traffic Signals II* (W. Brilon, ed.), Springer-Verlag, Germany, 1991, pp. 107–125.
6. Brown, M. *TRL State of the Art Review: The Design of Roundabouts*. London, HMSO, 1995.
7. Garder, P. *The Modern Roundabouts: The Sensible Alternative for Maine*. Maine Department of Transportation, Bureau of Planning, Research and Community Services, Transportation Research Division, 1998.
8. Guichet, B. "Roundabouts in France: Development, Safety, Design, and Capacity." In *Proceedings of the Third International Symposium on Intersections without Traffic Signals* (M. Kyte, ed.), Portland, Oregon, University of Idaho, Moscow, Idaho, 1997.
9. Mandavilli, S., A. McCartt, and R. Retting. *Crash Patterns and Potential Engineering Countermeasures at Maryland Roundabouts*. Insurance Institute for Highway Safety, Arlington, Virginia, May 2008.
10. "Safety of Roundabouts in Urban and Suburban Areas." Centre d'Etude des Transports Urbains (CETUR), Paris, 1992.
11. Arndt, O., "Road Design Incorporating Three Fundamental Safety Parameters." *Technology Transfer Forum 5 & 6*, Transport Technology Division, Main Roads Department, Queensland, Australia, August 1998.
12. Bared, J. G. and K. Kennedy. "Safety Impacts of Modern Roundabouts." In *ITE Safety Toolbox*, Institute of Transportation Engineers, 1999.
13. Leaf, W. A. and D. F. Preusser. *Literature Review on Vehicle Travel Speeds and Pedestrian Injuries*. Final Report DOT HS 809 021. National Highway Traffic Safety Administration, Department of Transportation, Washington, D.C., October 1999.

14. Crown, B. "An Introduction to Some Basic Principles of U.K. Roundabouts Design." Presented at the ITE District 6 Conference on Roundabouts, Loveland, Colorado, October 1998.
15. Seim, K. "Use, Design and Safety of Small Roundabouts in Norway." In *Intersections without Traffic Signals II* (W. Brilon, ed.), Springer-Verlag, Germany, 1991, pp. 270–281.
16. Van Minnen, J. "Safety of Bicyclists on Roundabouts Deserves Special Attention." *Research Activities 5*, SWOV Institute of Road Safety Research in the Netherlands, March 1996.
17. FHWA. *SafetyAnalyst*. www.safetyanalyst.org/. Accessed August 2009.
18. Council, F., E. Zaloshnja, T. Miller, and B. Persaud. *Crash Cost Estimates by Maximum Police-Reported Injury Severity within Selected Crash Geometries*. Report No. FHWA-HRT-05-051. FHWA, Washington, D.C., October 2005.

CHAPTER 6 GEOMETRIC DESIGN

CONTENTS

6.1 INTRODUCTION	6-6
6.2 PRINCIPLES AND OBJECTIVES	6-8
6.2.1 Speed Management	6-9
6.2.2 Lane Arrangements	6-10
6.2.3 Appropriate Path Alignment	6-11
6.2.4 Design Vehicle	6-13
6.2.5 Nonmotorized Design Users	6-14
6.2.6 Sight Distance and Visibility	6-15
6.3 SIZE, POSITION, AND ALIGNMENT OF APPROACHES	6-16
6.3.1 Inscribed Circle Diameter	6-17
6.3.2 Alignment of Approaches	6-18
6.3.3 Angle between Approach Legs	6-20
6.4 SINGLE-LANE ROUNDABOUTS	6-22
6.4.1 Splitter Islands	6-22
6.4.2 Entry Width	6-24
6.4.3 Circulatory Roadway Width	6-24
6.4.4 Central Island	6-25
6.4.5 Entry Design	6-26
6.4.6 Exit Design	6-27
6.4.7 Design Vehicle Considerations	6-29
6.5 MULTILANE ROUNDABOUTS	6-33
6.5.1 Lane Numbers and Arrangements	6-34
6.5.2 Entry Width	6-35
6.5.3 Circulatory Roadway Widths	6-36
6.5.4 Entry Geometry and Approach Alignment	6-38
6.5.5 Splitter Islands	6-41
6.5.6 Exit Curves	6-42
6.5.7 Design Vehicle Considerations	6-44
6.5.8 Other Design Practices	6-45

Roundabouts: An Informational Guide

6.6 MINI-ROUNDBABOUTS	6-45
6.6.1 General Design Criteria for Mini-Roundabouts	6-46
6.6.2 Design Considerations for Mini-Roundabouts at Three-Leg Intersections	6-51
6.6.3 Right-Turn Bypass Lanes	6-52
6.7 PERFORMANCE CHECKS	6-53
6.7.1 Fastest Path	6-53
6.7.2 Path Alignment (Natural Path) Considerations	6-59
6.7.3 Sight Distance	6-60
6.7.4 Angles of Visibility	6-65
6.8 DESIGN DETAILS	6-67
6.8.1 Pedestrian Design Considerations	6-67
6.8.2 Bicycle Design Considerations	6-71
6.8.3 Parking Considerations	6-75
6.8.4 Bus Stop Locations	6-75
6.8.5 Treatments for High-Speed Approaches	6-76
6.8.6 Right-Turn Bypass Lanes	6-78
6.8.7 Vertical Considerations	6-82
6.8.8 Materials and Design Details	6-87
6.9 CLOSELY SPACED ROUNDBABOUTS	6-90
6.10 INTERCHANGES	6-91
6.10.1 Diamond Interchange	6-91
6.10.2 Single-Point Diamond Interchange	6-94
6.11 ACCESS MANAGEMENT	6-95
6.11.1 Access into the Roundabout	6-95
6.11.2 Access near the Roundabout	6-96
6.12 STAGING OF IMPROVEMENTS	6-98
6.12.1 Expansion to the Outside	6-99
6.12.2 Expansion to the Inside	6-100
6.13 REFERENCES	6-102

LIST OF EXHIBITS

Exhibit 6-1 General Design Process	6-7
Exhibit 6-2 Basic Geometric Elements of a Roundabout	6-9
Exhibit 6-3 Example of Using Geometry to Manage Vehicle Speeds	6-10
Exhibit 6-4 Lane Configuration Example	6-11
Exhibit 6-5 Path Overlap at a Multilane Roundabout	6-12
Exhibit 6-6 Example of Roundabout Designed for Large Trucks	6-13
Exhibit 6-7 Key Dimensions of Non-Motorized Design Users	6-14
Exhibit 6-8 Example of Sketch Iterations	6-16
Exhibit 6-9 Typical Inscribed Circle Diameter Ranges	6-18
Exhibit 6-10 Entry Alignment Alternatives	6-19
Exhibit 6-11 Angle between Legs	6-21
Exhibit 6-12 Minimum Splitter Island Dimensions	6-23
Exhibit 6-13 Typical Minimum Splitter Island Nose Radii and Offsets	6-24
Exhibit 6-14 Single-Lane Roundabout Entry Design	6-26
Exhibit 6-15 Single-Lane Roundabout Curvilinear Exit Design	6-28
Exhibit 6-16 Single-Lane Roundabout Large Radius Exit Design	6-28
Exhibit 6-17 Through Movement Swept Path of WB-50 (WB-15) Vehicle	6-29
Exhibit 6-18 Turning Movement Swept Paths of WB-50 (WB-15) Vehicle	6-29
Exhibit 6-19 Vehicle Over-Tracking from Inadequate Entry and Exit Design	6-30
Exhibit 6-20 Roundabout with High Volume of Heavy Vehicles	6-31
Exhibit 6-21 Comparison of Swept Paths for a WB-67 Design Vehicle at Various Diameters	6-32
Exhibit 6-22 Example of Aesthetic Truck Apron Treatments	6-33
Exhibit 6-23 Example of Waffle Blocks Used within a Truck Apron	6-33
Exhibit 6-24 Approach Widening by Adding a Full Lane	6-35
Exhibit 6-25 Approach Widening by Entry Flaring	6-36
Exhibit 6-26 Multilane Major Street with Single Lane on Minor Street	6-37
Exhibit 6-27 Two-Lane Roundabout with Consecutive Double-Lefts	6-37
Exhibit 6-28 Entry Vehicle Path Overlap	6-38
Exhibit 6-29 Desirable Vehicle Path Alignment	6-39
Exhibit 6-30 Example Minor Approach Offset to Increase Entry Deflection	6-39
Exhibit 6-31 Example of Major Approach Offset to Increase Entry Deflection	6-41

Roundabouts: An Informational Guide

Exhibit 6-32	Example of a Partial Three Lane Roundabout with an Offset Approach Alignment	6-41
Exhibit 6-33	Exit–Circulating Conflict Caused by Large Separation between Legs	6-42
Exhibit 6-34	Possible Lane Configuration Modifications to Resolve Exit–Circulating Conflicts	6-43
Exhibit 6-35	Realignment to Resolve Exit–Circulating Conflicts	6-43
Exhibit 6-36	Side-by-Side Navigation for a Bus and Passenger Car	6-44
Exhibit 6-37	WB-67 (WB-20) Truck Path with Gore Striping at Entry	6-45
Exhibit 6-38	Basic Characteristics of a Mini-Roundabout	6-46
Exhibit 6-39	Design That Allows Left Turns in Front of Central Island	6-48
Exhibit 6-40	Possible Design Improvements to Resolve Turning in Front of Mini-Roundabout Central Island	6-48
Exhibit 6-41	Raised Splitter Island Terminated in Advance of the Entrance Line	6-50
Exhibit 6-42	Mini-Roundabout within Existing Intersection Footprint	6-51
Exhibit 6-43	Mini-Roundabout with Central Island Centered Along Major Roadway	6-52
Exhibit 6-44	Mini-Roundabout with Inscribed Circle Shifted along Minor Street Axis	6-52
Exhibit 6-45	Mini-Roundabout with Right Turn Bypass Lane	6-53
Exhibit 6-46	Vehicle Path Radii	6-54
Exhibit 6-47	Recommended Maximum Entry Design Speeds	6-54
Exhibit 6-48	Fastest Vehicle Path through Single-Lane Roundabout	6-55
Exhibit 6-49	Fastest Vehicle Path through Multilane Roundabout	6-55
Exhibit 6-50	Example of Critical Right-Turn Movement	6-56
Exhibit 6-51	Guidance on Drawing and Measuring the Entry Path Radius	6-56
Exhibit 6-52	Speed–Radius Relationship	6-57
Exhibit 6-53	Natural Vehicle Path Sketched through Roundabout	6-60
Exhibit 6-54	Computed Values for Stopping Sight Distance	6-61
Exhibit 6-55	Stopping Sight Distance on the Approach	6-62
Exhibit 6-56	Stopping Sight Distance on Circulatory Roadway	6-62
Exhibit 6-57	Sight Distance to Crosswalk on Exit	6-62
Exhibit 6-58	Intersection Sight Distance	6-63
Exhibit 6-59	Computed Length of Conflicting Leg of Intersection Sight Triangle	6-64
Exhibit 6-60	Example Sight Distance Diagram	6-65
Exhibit 6-61	Example Design with Severe Angle of Visibility to Left	6-66

Exhibit 6-62 Roundabout with Realigned Ramp Terminal Approach to Provide Better Angle of Visibility to the Left	6-66
Exhibit 6-63 Sidewalk Treatment Example	6-67
Exhibit 6-64 Alternative Sidewalk Treatments	6-68
Exhibit 6-65 Example Sidewalk Setback at Roundabouts	6-68
Exhibit 6-66 Crosswalk Alignment Options	6-70
Exhibit 6-67 Possible Treatments for Bicycles	6-74
Exhibit 6-68 Bicycle Ramp Design Options	6-74
Exhibit 6-69 Extended Splitter Island Treatment	6-77
Exhibit 6-70 Use of Successive Curves on High-Speed Approaches	6-78
Exhibit 6-71 Examples of Right-turn Bypass Lane	6-79
Exhibit 6-72 Configuration of Right-turn Bypass Lane with Acceleration Lane	6-80
Exhibit 6-73 Configuration of Right-turn Bypass Lane with Yield at Exit Leg	6-80
Exhibit 6-74 Exclusive Right-Turn Lane Designs	6-81
Exhibit 6-75 Sample Central Island Profile	6-82
Exhibit 6-76 Typical Section with a Truck Apron	6-85
Exhibit 6-77 Typical Section with Crowned Circulatory Roadway	6-85
Exhibit 6-78 Examples of Sloping Truck Apron Curb Shapes Used in the United States	6-86
Exhibit 6-79 Example Concrete Jointing Patterns	6-88
Exhibit 6-80 Example Concrete Jointing Patterns	6-89
Exhibit 6-81 Examples of Closely Spaced Roundabouts	6-90
Exhibit 6-82 Conceptual Diamond Interchange	6-91
Exhibit 6-83 Conceptual Diamond Interchange with Frontage Roads	6-92
Exhibit 6-84 Example of Interchange with Circular Central Islands	6-92
Exhibit 6-85 Example of a Compact Interchange with Raindrop-Shaped Central Islands	6-93
Exhibit 6-86 Example of Interchange with Raindrop-Shaped Central Islands . .	6-93
Exhibit 6-87 Single-Point Diamond Interchange with One Roundabout	6-94
Exhibit 6-88 Example Split Diamond Single-Point Interchange	6-94
Exhibit 6-89 Example of Residential Driveways into Circulatory Roadway . .	6-96
Exhibit 6-90 Example of Driveway Challenges near Roundabout	6-97
Exhibit 6-91 Typical Dimensions for Left-Turn Access near Roundabouts . . .	6-98
Exhibit 6-92 Staged Multilane Roundabout	6-101

Roundabout design involves trade-offs between safety, operations, and accommodation of the design vehicle.

Some roundabout features are uniform, while others vary depending on the location and size of the roundabout.

The contents of this chapter are intended to serve as guidance, not as a standard or rule.

The use of a design technique not explicitly included in this chapter or a value that falls outside of the ranges presented in this chapter does not automatically create a fatal flaw or unsafe condition provided that the design principles can be achieved.

Roundabout design is an iterative process.

6.1 INTRODUCTION

The geometric design of a roundabout requires the balancing of competing design objectives. Roundabouts operate most safely when their geometry forces traffic to enter and circulate at slow speeds. Poor roundabout geometry has been found to negatively impact roundabout operations by affecting driver lane choice and behavior through the roundabout. Many of the geometric parameters are governed by the maneuvering requirements of the design vehicle. Thus, designing a roundabout is a process of determining the optimal balance between safety provisions, operational performance, and accommodation of the design vehicle.

While the basic form and features of roundabouts are usually independent of their location, many of the design outcomes depend on the surrounding speed environment, desired capacity, available space, required numbers and arrangements of lanes, design vehicle, and other geometric attributes unique to each individual site. In rural environments where approach speeds are high and bicycle and pedestrian use may be minimal, the design objectives are significantly different from roundabouts in urban environments where bicycle and pedestrian safety are a primary concern. Additionally, many of the design techniques are substantially different for single-lane roundabouts than for roundabouts with two or more lanes.

The contents of this chapter are intended to serve as guidance and should not be interpreted as a standard or rule. As described in this chapter, roundabout design is an iterative process where a variety of design objectives must be considered and balanced within site-specific constraints. Maximizing the operational performance and safety for a roundabout requires the engineer to think through the design rather than rely upon a design template. Throughout this chapter, ranges of typical values are given for many of the different geometric elements to provide guidance in the design of individual roundabout components. The use of a design technique not explicitly included in this chapter or a value that falls outside of the ranges presented does not automatically create a fatal flaw or unsafe condition provided that the design principles presented in Section 6.2 can be achieved.

Exhibit 6-1 provides a general outline for the design process, incorporating elements of project planning, preliminary design, and final design into an iterative process. Information from the operational analysis is used to determine the required number of lanes for the roundabout (single or multilane), which dictates the required size and many other design details. The basic design should be laid out based upon the principles identified in Section 6.2 to a level that allows the engineer to verify that the layout will meet the design objectives. The key is to conduct enough work to be able to check the design and identify whether adjustments are necessary. Once enough iteration has been performed to identify an optimum size, location, and set of approach alignments, additional detail can be added to the design based upon more specific information provided in Sections 6.4 through 6.6 related to single-lane, multilane, and mini-roundabouts respectively.

Exhibit 6-1
General Design Process

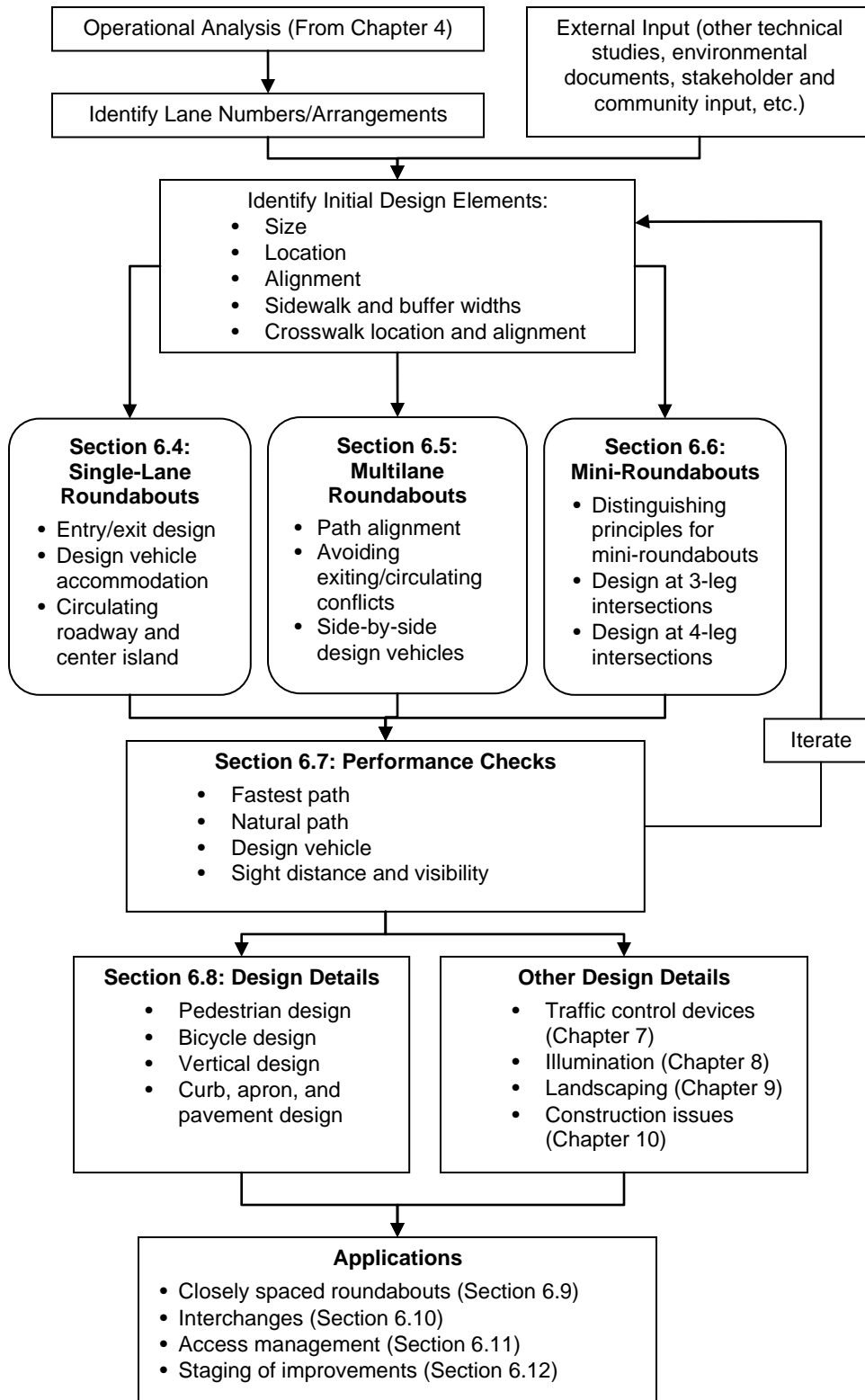

This chapter is organized such that the design principles common among all roundabout types are presented first. Even at the concept level, engineers are encouraged to develop designs that are consistent with the design principles in order to depict realistic impacts and to better define the required geometry. Poor concepts can lead to poor decision-making at the feasibility stage and can make it more difficult to generate large changes to a design at a later stage. More detailed design considerations specific to single-lane, multilane, and mini-roundabouts are given in subsequent sections of the chapter.

6.2 PRINCIPLES AND OBJECTIVES

This section describes the principles and objectives common to the design of all categories of roundabouts. Note that some features of multilane roundabout design are significantly different from single-lane roundabout design, and some techniques used in single-lane roundabout design may not directly transfer to multilane design. However, several overarching principles should guide the development of all roundabout designs.

Achieving these principles should be the goal of any roundabout design:

- Provide slow entry speeds and consistent speeds through the roundabout by using deflection.
- Provide the appropriate number of lanes and lane assignment to achieve adequate capacity, lane volume balance, and lane continuity.
- Provide smooth channelization that is intuitive to drivers and results in vehicles naturally using the intended lanes.
- Provide adequate accommodation for the design vehicles.
- Design to meet the needs of pedestrians and cyclists.
- Provide appropriate sight distance and visibility for driver recognition of the intersection and conflicting users.

Each of the principles described above affects the safety and operations of the roundabout. When developing a design, the trade-offs of safety, capacity, cost, and so on must be recognized and assessed throughout the design process. Favoring one component of design may negatively affect another. A common example of such a trade-off is accommodating large trucks on the roundabout approach and entry while maintaining slow design speeds. Increasing the entry width or entry radius to better accommodate a large truck may simultaneously increase the speeds that vehicles can enter the roundabout. Therefore, the engineer must balance these competing needs and may need to adjust the initial design parameters. To both accommodate the design vehicle and maintain slow speeds, additional design modifications could be required, such as offsetting the approach alignment to the left or increasing the inscribed circle diameter of the roundabout.

Exhibit 6-2 provides a review of the basic geometric features and key dimensions of a roundabout.

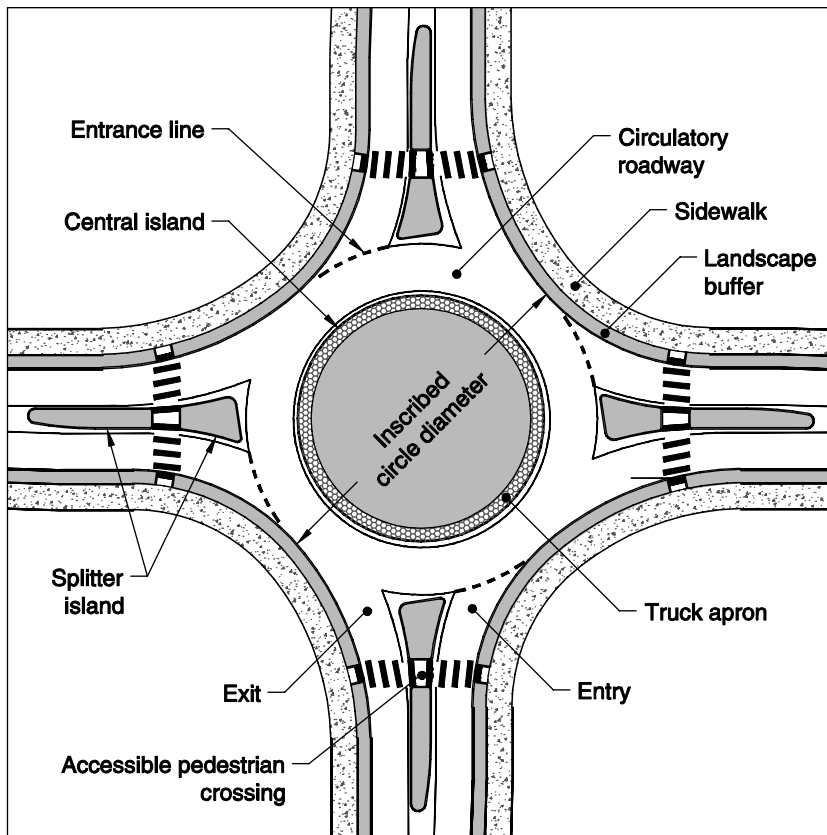

Exhibit 6-2
Basic Geometric Elements of
a Roundabout

6.2.1 SPEED MANAGEMENT

Achieving appropriate vehicular speeds for entering and traveling through the roundabout is a critical design objective as it has profound impacts on safety of all users; it also makes roundabouts easier to use and more comfortable for pedestrians and bicyclists. A well-designed roundabout reduces vehicle speeds upon entry and achieves consistency in the relative speeds between conflicting traffic streams by requiring vehicles to negotiate the roundabout along a curved path. Exhibit 6-3 shows an example of a roundabout where the approach alignment and entry geometry manage speeds entering the roundabout.

The operating speed of a roundabout is widely recognized as one of its most important attributes in terms of safety performance (1). Although the frequency of crashes is most directly tied to volume, the severity of crashes is most directly tied to speed. Therefore, careful attention to the design speed of a roundabout is fundamental to attaining good safety performance (2). Maximum entering design speeds based on a theoretical fastest path of 20 to 25 mph (32 to 40 km/h) are recommended at single-lane roundabouts. At multilane roundabouts, maximum entering design speeds of 25 to 30 mph (40 to 48 km/h) are recommended based on a theoretical fastest path assuming vehicles ignore all lane lines. These speeds are influenced by a variety of factors, including the geometry of the roundabout and the operating speeds of the approaching roadways. As a result, speed management is often a combination of managing speeds at the roundabout itself and managing speeds on the approaching roadways.

The most critical design objective is to maintain low and consistent speeds at the entry and through the roundabout.

Roundabouts: An Informational Guide
Exhibit 6-3

Example of Using Geometry
to Manage Vehicle Speeds



Kennewick, Washington

International studies have shown that reducing the vehicle path radius at the entry (i.e., deflecting the vehicle path) decreases the relative speed between entering and circulating vehicles and thus results in lower entering–circulating vehicle crash rates. However, reducing the vehicle path radius at multilane roundabouts can, if not well designed, create poor path alignment (path overlap), greater side friction between adjacent traffic streams, and a higher potential for sideswipe crashes (3). Therefore, care must be taken in design to promote drivers naturally maintaining their lane. Guidance on measuring vehicle fastest path speeds is provided in Section 6.7.1.

In addition to achieving an appropriate design speed for the fastest movements, another important objective is to achieve consistent speeds for all movements. Along with overall reductions in speed, speed consistency can help to minimize the crash rate between conflicting streams of vehicles. This principle has two implications:

- The relative speeds between consecutive geometric elements should be minimized, and
- The relative speeds between conflicting traffic streams should be minimized.

6.2.2 LANE ARRANGEMENTS

Chapter 4 provides the methodologies for conducting an operational analysis for a roundabout. An outcome of that analysis is the required number of entry lanes to serve each of the approaches to the roundabout. For multilane roundabouts, care must be taken to ensure that the design also provides the appropriate number of lanes within the circulatory roadway and on each exit to ensure lane continuity.

Exhibit 6-4 illustrates a two-lane roundabout where the needed lane configurations on the eastbound approach are a left-turn and a shared left-through-right turn lane. For this lane configuration, two receiving lanes are needed within the circulatory roadway. However, the exit for the through movement must be a single lane to ensure proper lane configurations. If a second exit lane was provided heading eastbound, the result would be overlapping vehicle paths between exiting vehicles on the inside lane and left-turning vehicles that continue to circulate around the outside lane.

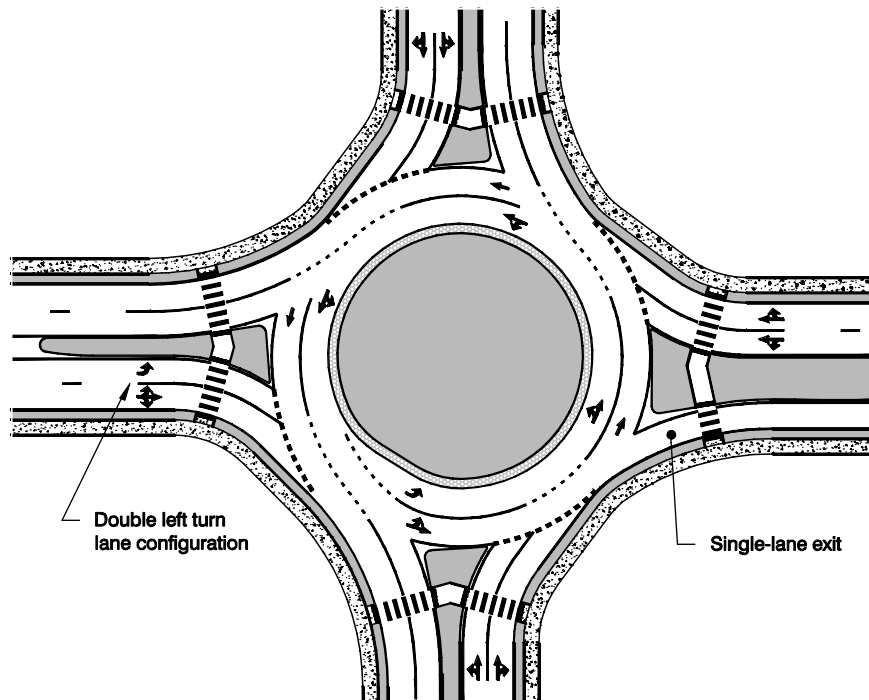

Exhibit 6-4
Lane Configuration Example

The allowed movements assigned to each entering lane are key to the overall design. Basic pavement marking layouts should be considered integral to the preliminary design process to ensure that lane continuity is being provided. In some cases, the geometry within the roundabout may be dictated by the number of lanes required or the need to provide spiral transitions (see Section 6.5 for more information). Lane assignments should be clearly identified on all preliminary designs in an effort to retain the lane configuration information through the various design iterations.

In some cases, a roundabout designed to accommodate design year traffic volumes, typically projected 20 years from the present, can result in substantially more entering, exiting, and circulating lanes than needed in the earlier years of operation. To maximize the potential safety during those early years of operation, the engineer may wish to consider a phased design solution that initially uses fewer entering and circulating lanes. As an example, the interim design would provide a single-lane entry to serve the near-term traffic volumes with the ability to cost-effectively expand the entries and circulatory roadway to accommodate future traffic volumes. To allow for expansion at a later phase, the ultimate configuration of the roundabout needs to be considered in the initial design. This requires that the ultimate horizontal and vertical design be identified to establish the outer envelope of the roundabout. Lanes are then removed from the ultimate design to provide the necessary capacity for the initial operation. This method helps to ensure that sufficient right-of-way is preserved and to minimize the degree to which the original roundabout must be rebuilt. Section 6.12 provides additional information on staging of improvements.

6.2.3 APPROPRIATE PATH ALIGNMENT

Path alignment at roundabouts draws parallels to conventional intersections and interchanges. At conventional intersections, drivers will tend to avoid driving immediately next to one another as they pass through small radius curves when

executing left or right turn movements. The same is true when drivers negotiate a two-lane loop ramp at an interchange. In both cases, the tendency to avoid traveling side-by-side is stronger when one of the vehicles is large like a truck. This overall behavior can also be seen at roundabouts. With this as background, engineers can nonetheless improve the operations and safety of a given multilane roundabout by paying attention to the path alignment of each traffic stream through it.

As two traffic streams approach the roundabout in adjacent lanes, vehicles will be guided by lane markings up to the entrance line. At the yield point, vehicles will continue along their natural trajectory into the circulatory roadway. The speed and orientation of the vehicle at the entrance line determines what can be described as its natural path. If the natural path of one lane interferes or overlaps with the natural path of the adjacent lane, the roundabout is not as likely to operate as safely or efficiently as possible. The geometry of the exits also affects the natural path that vehicles will travel. Overly small exit radii on multilane roundabouts may also result in overlapping vehicle paths on the exit.

A good multilane entry design aligns vehicles into the appropriate lane within the circulatory roadway. Likewise, the design of the exits should also provide appropriate alignment to allow drivers to intuitively maintain the appropriate lane. These alignment considerations often compete with the fastest path speed objectives.

Vehicle path overlap occurs when the natural path through the roundabout of one traffic stream overlaps the path of another. This can happen to varying degrees, and it can have varying consequences. For example, path overlap can reduce capacity because vehicles will avoid using one or more of the entry lanes. Path overlap can also create safety problems since the potential for sideswipe and single-vehicle crashes is increased. The most common type of path overlap is where vehicles in the left lane on entry are cut off by vehicles in the right lane due to inadequate entry path alignment, as shown in Exhibit 6-5. However, path overlap can also occur

Exhibit 6-5
Path Overlap at
a Multilane Roundabout

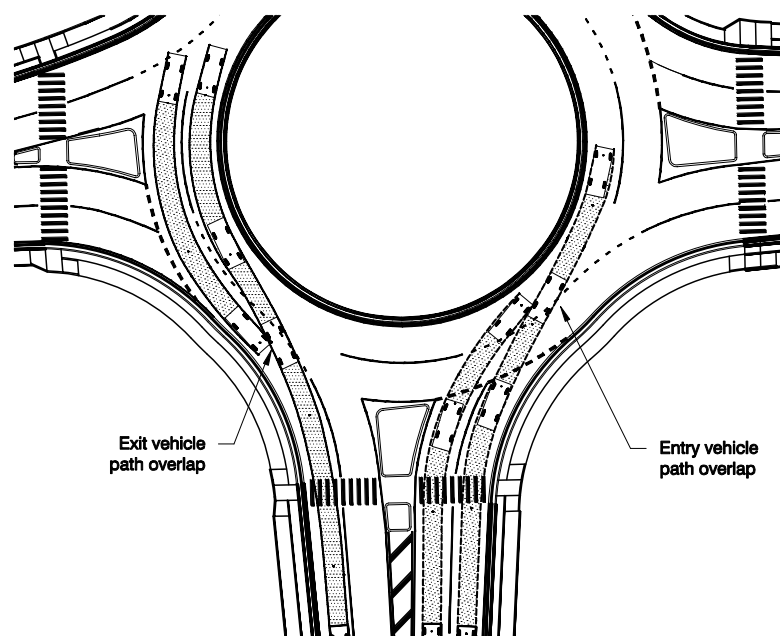

upon the exit from the roundabout where the exit radii are too small or the overall exit geometry does not adequately align the vehicle paths into the appropriate lane. Additional information on entry and exit design at multilane roundabouts is provided in Section 6.5.

6.2.4 DESIGN VEHICLE

Another important factor affecting a roundabout's layout is the need to accommodate the largest vehicle likely to use the intersection. The turning path requirements of this vehicle, termed hereafter the *design vehicle*, will dictate many of the roundabout's dimensions. Before beginning the design process, the engineer must be conscious of the design vehicle and possess the appropriate vehicle turning templates or a CAD-based vehicle turning path program to determine the vehicle's swept path.

Because roundabouts are intentionally designed to slow traffic, narrow curb-to-curb widths and tight turning radii are typically used. However, if the widths and turning requirements are designed too tight, it can create difficulties for large vehicles. Large trucks and buses often dictate many of the roundabout's dimensions, particularly for single-lane roundabouts. Therefore, it is very important to determine the design vehicle at the start of the design and investigation process.

Exhibit 6-6 illustrates an example of a single-lane roundabout that adequately accommodates the design vehicle. In this example, the tractor-trailer combination is accommodated using an apron within the central island. The apron provides additional paved surface to accommodate the wide path of the trailer, but keeps the actual circulatory roadway width narrow enough to maintain speed control for smaller passenger cars. As shown in the photo, the size of the roundabout also allows the cab of the truck to successfully navigate through the intersection without running over the outer curb lines.

The choice of design vehicle will vary depending on the approaching roadway types and the surrounding land use characteristics. The local or state agency with jurisdiction of the associated roadways should usually be consulted to identify the appropriate design vehicle for a given site. AASHTO's *A Policy on Geometric Design*

The design vehicle dictates many of the roundabout's dimensions.



Lothian, Maryland

Exhibit 6-6
Example of Roundabout
Designed for Large Trucks

of *Highways and Streets* provides the dimensions and turning path requirements for a variety of common highway vehicles (4).

Commonly, WB-50 (WB-15) vehicles are the largest vehicles along urban collectors and arterials. Larger trucks, such as WB-67 (WB-20) vehicles, may need to be addressed at intersections on interstate freeway or state highway systems. Smaller design vehicles may often be chosen at local street intersections. At a minimum, fire engines, transit vehicles, and single-unit delivery vehicles should be considered in urban areas, and it is desirable that these vehicles be accommodated without the use of the truck apron. In rural environments, farming or mining equipment may govern design vehicle needs.

Oversized vehicles (sometimes referred to as “superloads”) are another potential design vehicle that may require consideration in some locations, particularly in rural areas and at freeway interchanges. These oversized vehicles occur relatively infrequently and typically require a special permit for traveling on the roadway. However, at locations where an oversized vehicle is anticipated, special consideration for the size and tolerances of these vehicles will need to be provided in the design and construction.

6.2.5 NON-MOTORIZED DESIGN USERS

As with the motorized design vehicle, the design criteria of non-motorized potential roundabout users (e.g., bicyclists, pedestrians, skaters, wheelchair users, strollers) should be considered when developing many of the geometric components of a roundabout design. These users span a wide range of ages and abilities and can have a significant effect on the design of a facility. The basic design dimensions for various design users are given in Exhibit 6-7.

Section 6.8 provides additional detail regarding design for pedestrians and bicyclists. There are two general design issues that are most important for non-motorized users. First, slow motor vehicle speeds make roundabouts both easier to use and safer for non-motorized users. Therefore, the use of low design speeds is

Exhibit 6-7
Key Dimensions of Non-Motorized Design Users

User	Dimension	Affected Roundabout Features
Bicyclist		
Length	5.9 ft (1.8 m)	Splitter island width at crosswalk
Minimum operating width	4 ft (1.2 m)	Bike lane width on approach roadways; shared use path width
Pedestrian (walking)		
Width	1.6 ft (0.5 m)	Sidewalk width, crosswalk width
Wheelchair user		
Minimum width	2.5 ft (0.75 m)	Sidewalk width, crosswalk width
Operating width	3.0 ft (0.90 m)	Sidewalk width, crosswalk width
Person pushing stroller		
Length	5.6 ft (1.70 m)	Splitter island width at crosswalk
Skaters		
Typical operating width	6 ft (1.8 m)	Sidewalk width

Source: (5)

recommended in areas where pedestrians and cyclists are common. Second, as described elsewhere in this document, one-lane roundabouts are generally easier and safer for non-motorized users than multilane roundabouts. Therefore care should be taken to not design a multilane roundabout when a single lane roundabout is sufficient (see Chapter 3).

For non-motorized users, one important consideration during the initial design stage is to maintain or obtain adequate right-of-way outside the circulatory roadway for the sidewalks. All non-motorized users who are likely to use the sidewalk regularly, including bicyclists in situations where roundabouts are designed to provide bicycle access to sidewalks, should be considered in the design of the sidewalk width. In addition, as discussed in Section 6.8.1, a planter strip is recommended between the sidewalk and the circulatory roadway, so even more right-of-way may be necessary.

For pedestrians, one key consideration at the initial design stage is to ensure that adequate pedestrian refuge width is provided within the splitter island. The design width for a refuge area should be a minimum of 6 ft (1.8 m) to accommodate a typical bicycle or person pushing a stroller. Pedestrian crossings are typically provided approximately one car length behind the entrance line. Pedestrians should also be discouraged from crossing to the central island.

An important consideration at roundabouts is the accommodation of visually impaired pedestrians. Pedestrians with vision impairments face several challenges at roundabouts, as described in detail in Chapter 2. These challenges magnify the need to maintain slow vehicle speeds within the area of the crosswalk, to provide intuitive crosswalk alignments, and to provide design elements that encourage drivers to yield to pedestrians in a predictable manner.

Bicycle lanes should not be provided through the roundabout and should be terminated upstream of the entrance line. Bicycle users are encouraged to merge into the general travel lanes and navigate the roundabout as a vehicle. The typical vehicle operating speed within the circulatory roadway is in the range of 15 to 25 mph (24 to 40 km/h), which is similar to that of a bicycle. Multilane roundabouts are more challenging for bicyclists, so additional design features may be appropriate, as discussed in Section 6.8.

6.2.6 SIGHT DISTANCE AND VISIBILITY

The visibility of the roundabout as vehicles approach the intersection and the sight distance for viewing vehicles already operating within the roundabout are key components for providing safe roundabout operations. Similar in application to other intersection forms, roundabouts require two types of sight distance to be verified: (1) stopping sight distance and (2) intersection sight distance. The design should be checked to ensure that stopping sight distance can be provided at every point within the roundabout and on each entering and exiting approach such that a driver can react to objects or other conflicting users (such as pedestrians and bicyclists) within the roadway.

Intersection sight distance must also be verified for any roundabout design to ensure that sufficient distance is available for drivers to perceive and react to the presence of conflicting vehicles, pedestrians, and bicyclists. Intersection

sight distance is measured for vehicles entering the roundabout, with conflicting vehicles along the circulatory roadway and entering from the immediate upstream entry taken into account.

International evidence suggests that it is advantageous to provide no more than the minimum required intersection sight distance on each approach (6). Excessive intersection sight distance can lead to higher vehicle speeds that reduce the safety of the intersection for all road users (motorists, bicyclists, pedestrians). Landscaping within the central island can be effective in restricting sight distance to the minimum requirements while creating a terminal vista on the approach to improve visibility of the central island.

6.3 SIZE, POSITION, AND ALIGNMENT OF APPROACHES

The design of a roundabout involves optimizing three design decisions to balance the design principles and objectives established in Section 6.2. The design decisions are optimizing (1) size, (2) position, and (3) the alignment of the approach legs. There are numerous possible combinations of each element, each with its own advantages and disadvantages. Selection of the optimum combination will often be based upon the constraints of the project site balanced with the ability to adequately control vehicle speeds, accommodate heavy vehicles, and meet the other design objectives.

Exhibit 6-8 provides three possible combinations of roundabout position and approach alignment for a specific intersection. In each example, the size of the inscribed circle has remained fixed. As can be imagined, many other

Three key design decisions are optimizing size, position, and the alignment of the approach legs.

Exhibit 6-8
Example of Sketch Iterations

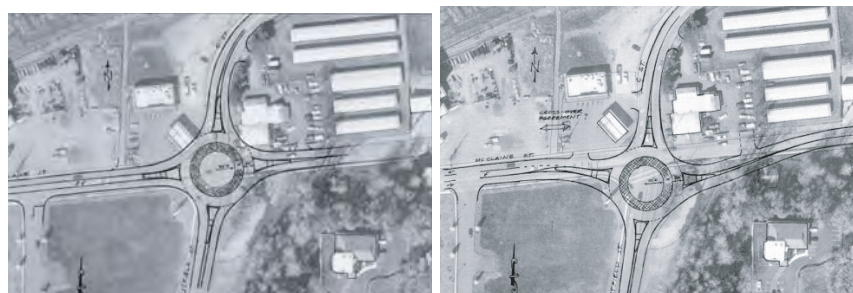

(a) Centered on Existing Intersection

(b) Center Shifted to the South



(c) Center Shifted to the East

possible alternatives could be developed by varying the size of the inscribed circle diameter.

Each of the alternatives shown in Exhibit 6-8 results in different impacts to the adjacent properties. Producing sketch-level designs of several alternatives aids the engineer in identifying these impacts and better evaluating the range of options that are available. It is important to note that where the location of the roundabout has been shifted from the center of the existing intersection, the approach alignments also require adjustment to achieve more perpendicular entries and to achieve speed control.

6.3.1 INSCRIBED CIRCLE DIAMETER

The inscribed circle diameter is the distance across the circle inscribed by the outer curb (or edge) of the circulatory roadway, as illustrated previously in Exhibit 6-2. It is the sum of the central island diameter and twice the circulatory roadway width. The inscribed circle diameter is determined by a number of design objectives, including accommodation of the design vehicle and providing speed control, and it may require iterative experimentation. Once a sketch-level design concept has been completed, the engineer is encouraged to look critically at the design to identify whether the initial assumed diameter produces a desired outcome (e.g., acceptable speeds, adequately serving the design vehicle, appropriate visibility for the central island) or whether a larger or smaller diameter would be beneficial.

At single-lane roundabouts, the size of the inscribed circle is largely dependent upon the turning requirements of the design vehicle. The diameter must be large enough to accommodate the design vehicle while maintaining adequate deflection curvature to ensure safe travel speeds for smaller vehicles. However, the circulatory roadway width, entry and exit widths, entry and exit radii, and entry and exit angles also play a significant role in accommodating the design vehicle and providing deflection. Careful selection of these geometric elements may allow a smaller inscribed circle diameter to be used in constrained locations. The inscribed circle diameter typically needs to be at least 105 ft (32 m) to accommodate a WB-50 (WB-15) design vehicle. Smaller roundabouts can be used for some local street or collector street intersections, where the design vehicle may be a bus or single-unit truck. For locations that must accommodate a larger WB-67 (WB-20) design vehicle, a larger inscribed circle diameter will be required, typically in the range of 130 to 150 ft (40 to 46 m). In situations with more than four legs, larger inscribed circle diameters may be appropriate. Truck aprons are typically needed to keep the inscribed circle diameter reasonable while accommodating the larger design vehicles.

At multilane roundabouts, the size of the roundabout is usually determined by balancing the need to achieve deflection with providing adequate alignment of the natural vehicle paths. Typically, achieving both of these critical design objectives requires a slightly larger diameter than used for single-lane roundabouts. Generally, the inscribed circle diameter of a multilane roundabout ranges from 150 to 250 ft (46 m to 76 m). For two-lane roundabouts, a common starting point is 160 to 180 ft (49 to 55 m). Roundabouts with three- or four-lane entries may require larger diameters of 180 to 330 ft (55 to 100 m) to achieve adequate speed control and

Selection of an inscribed circle diameter is generally the first step in the design process. After completion of a concept design, a critical eye should be given to evaluating whether the initial assumed diameter is optimal.

The inscribed circle diameter must be large enough to accommodate the design vehicle while maintaining slower speeds for small vehicles.

The inscribed circle diameter for a single-lane roundabout typically needs to be at least 105 ft (32 m) to accommodate a WB-50 (WB-15) design vehicle; a larger diameter is typically needed for design vehicles larger than a WB-50 (WB-15).

Diameters in the range of 120 to 140 ft (36 to 43 m) are common starting points for single-lane roundabouts.

For a two-lane roundabout, the minimum inscribed circle diameter is typically 150 ft (46 m). Diameters in the range of 160 to 180 ft (49 to 55 m) are common starting points for two-lane roundabout design.

alignment (7). Truck aprons are sometimes needed to keep the inscribed circle diameter reasonable while accommodating the larger design vehicles.

Mini-roundabouts serve as a special subset of roundabouts and are defined by their small inscribed circle diameters. With a diameter less than 90 ft, the mini-roundabout is smaller than the typical single-lane roundabout. The small diameter is made possible by the use of a fully traversable central island to accommodate large vehicles, as opposed to the typical single-lane roundabout where the diameter must be large enough to accommodate a heavy vehicle within the circulatory roadway (and truck apron if applicable) without it needing to travel over the central island. The small footprint of a mini-roundabout offers flexibility in working within constrained sites. However, as described in Section 6.6, it also has limitations to where it may be appropriate due to the reduced ability control speeds with the traversable central island. Trade-offs of using the smaller diameter mini-roundabout versus the larger-diameter typical single-lane roundabout should be considered based upon the unique site conditions.

Exhibit 6-9 provides typical ranges of inscribed circle diameters for various site locations.

Exhibit 6-9
Typical Inscribed Circle
Diameter Ranges

Roundabout Configuration	Typical Design Vehicle	Common Inscribed Circle Diameter Range*	
Mini-Roundabout	SU-30 (SU-9)	45 to 90 ft	(14 to 27 m)
Single-Lane Roundabout	B-40 (B-12)	90 to 150 ft	(27 to 46 m)
	WB-50 (WB-15)	105 to 150 ft	(32 to 46 m)
	WB-67 (WB-20)	130 to 180 ft	(40 to 55 m)
Multilane Roundabout (2 lanes)	WB-50 (WB-15)	150 to 220 ft	(46 to 67 m)
	WB-67 (WB-20)	165 to 220 ft	(50 to 67 m)
Multilane Roundabout (3 lanes)	WB-50 (WB-15)	200 to 250 ft	(61 to 76 m)
	WB-67 (WB-20)	220 to 300 ft	(67 to 91 m)

* Assumes 90° angles between entries and no more than four legs. List of possible design vehicles is not all-inclusive.

For initial selection of an inscribed circle diameter using Exhibit 6-9, the intersection design vehicle and the context of the location should be taken into consideration. For instance, in a constrained urban location, selection of a diameter at the low end of the identified range may be needed due to right-of-way constraints but may not allow for the same degree of deflection and speed control as would a larger diameter. Conversely, in a higher-speed rural location, a larger-diameter roundabout may have a larger footprint but may be required to accommodate large trucks while providing increased visibility and speed control.

6.3.2 ALIGNMENT OF APPROACHES

The alignment of the approach legs plays an important role in the design of a roundabout. The alignment affects the amount of deflection (speed control) that is achieved, the ability to accommodate the design vehicle, and the visibility angles to adjacent legs. The optimal alignment is generally governed by the size and position of the roundabout relative to its approaches. Various options for approach alignment are summarized in Exhibit 6-10.

Roundabout approach alignments should generally pass to the left or through the center of the inscribed circle.

Exhibit 6-10
 Entry Alignment Alternatives

Entry Alignment
Question

Should the approach alignment run through the center of the inscribed circle? Or is it acceptable to offset the approach centerline to one side?

Design Principle

The alignment does not have to pass through the center of the roundabout; however, it has a primary effect on the entry/exit design. The optimal alignment allows for an entry design that provides adequate deflection and speed control while also providing appropriate view angles to drivers and balancing property impacts/costs.

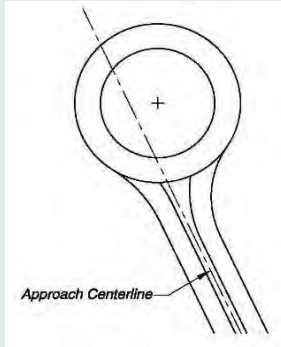
Alternative 1: Offset Alignment to the Left of Center

ADVANTAGES:

- Allows for increased deflection
- Beneficial for accommodating large trucks with small inscribed circle diameter—allows for larger entry radius while maintaining deflection and speed control
- May reduce impacts to right-side of roadway

TRADE-OFFS

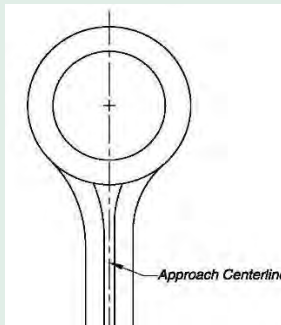
- Increased exit radius or tangential exit reduces control of exit speeds and acceleration through crosswalk area
- May create greater impacts to the left side of the roadway

Alternative 2: Alignment through Center of Roundabout

ADVANTAGES:

- Reduces amount of alignment changes along the approach roadway to keep impacts more localized to intersection
- Allows for some exit curvature to encourage drivers to maintain slower speeds through the exit

TRADE-OFFS

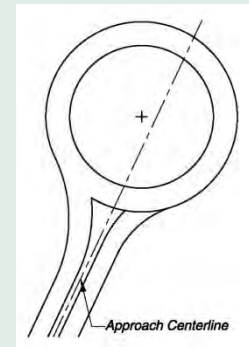
- Increased exit radius reduces control of exit speeds/acceleration through crosswalk area
- May require a slightly larger inscribed circle diameter (compared to offset-left design) to provide the same level of speed control

Alternative 3: Alignment to Right of Center

ADVANTAGES:

- Could be used for large inscribed circle diameter roundabouts where speed control objectives can still be met
- Although not commonly used, this strategy may be appropriate in some instances (provided that speed objectives are met) to minimize impacts, improve view angles, etc.

TRADE-OFFS

- Often more difficult to achieve speed control objectives, particularly at small diameter roundabouts
- Increases the amount of exit curvature that must be negotiated

A common starting point in design is to center the roundabout so that the centerline of each leg passes through the center of the inscribed circle (radial alignment). This location typically allows the geometry of a single-lane roundabout to be adequately designed such that vehicles will maintain slow speeds through both the entries and the exits. The radial alignment also makes the central island more conspicuous to approaching drivers and minimizes roadway modification required upstream of the intersection.

Another frequently acceptable alternative is to offset the centerline of the approach to the left (i.e., the centerline passes to the left of the roundabout's center point). This alignment will typically increase the deflection achieved at the entry to improve speed control. However, engineers should recognize the inherent trade-off of a larger radius (or tangential) exit that may provide less speed control for the downstream pedestrian crossing. Especially in urban environments, it is important to have drivers maintain sufficiently low vehicular speeds at the pedestrian crossing to reduce the risk for pedestrians. The fastest-path procedure provided in Section 6.7.1 identifies a methodology for estimating speeds for large radius (or tangential) exits where acceleration may govern the attainable speed.

Approach alignments that are offset to the right of the roundabout's center point typically do not achieve satisfactory results, primarily due to a lack of deflection and lack of speed control that result from this alignment. An offset-right alignment brings the approach in at a more tangential angle and reduces the opportunity to provide sufficient entry curvature. Vehicles will usually be able to enter the roundabout too fast, resulting in more loss-of-control crashes and higher crash rates between entering and circulating vehicles. However, an offset-right alignment alone should not be considered a fatal flaw in a design if speed requirements and other design considerations can be met.

6.3.3 ANGLE BETWEEN APPROACH LEGS

Similar to signalized and stop-controlled intersections, the angle between approach legs is also an important design consideration. Although it is not necessary for opposing legs to align directly opposite one another (as it is for conventional intersections), it is generally preferable for the approaches to intersect at perpendicular or near-perpendicular intersection angles. If two approach legs intersect at an angle significantly greater than 90° , it will often result in excessive speeds for one or more right-turn movements. Alternatively, if two approach legs intersect at an angle significantly less than 90° , then the difficulty for large trucks to successfully navigate the turn is increased. Providing a large corner radius to accommodate trucks may result in a wide portion of circulatory roadway resulting in increased speeds and may also lead to reduced safety performance if the circulatory roadway width is mistakenly interpreted by drivers to be two lanes. Designing the approaches at perpendicular or near-perpendicular angles generally results in relatively slow and consistent speeds for all movements. Highly skewed intersection angles can often require significantly larger inscribed circle diameters to achieve the speed objectives (8).

Exhibit 6-11 illustrates the fastest paths at a roundabout with perpendicular approach angles versus a roundabout with obtuse approach angles. As this figure implies, it is desirable for roundabout T-intersections to intersect as close to 90° as

Angle between Approach Legs

Question

Is it acceptable to have a skewed angle between intersection legs or do the angles always need to be perpendicular?

Design Principle

The angle between legs may affect the ability to achieve slow fastest-path speeds, may affect navigation of large vehicles, and can complicate the signing and marking. In general, it will be easier to achieve the design objectives if the approach legs are nearly perpendicular to each other. However, perpendicular approaches are not a design requirement. Acceptable designs can be achieved with skewed angles between approaches with corresponding adjustments to other design components.

Perpendicular Legs

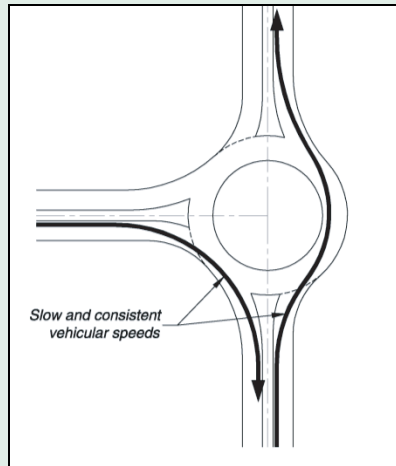

Perpendicular approach angles will generally provide slow and consistent speeds when used in combination with other appropriately sized design features. Achieving acceptable fastest-path speeds is often easier to accomplish with a perpendicular approach angle than with a skew.

Where the intersecting roadways are skewed under existing conditions, realignment of one or more approach legs would be required to achieve this ideal condition. The ability to realign a leg may depend on other site constraints and may not be feasible in all locations. Realigning to achieve an angle as close to 90 degrees as practical is generally desirable.

Large Angle between Legs

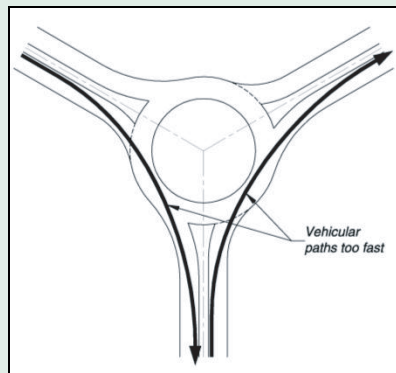

In situations involving a large angle between legs, it is desirable to realign one or more legs to try to achieve a more perpendicular condition. Large angles make it difficult to provide adequate deflection and may result in fast vehicle speeds, particularly for the right-turn movements.

Options to achieve adequate speed control without realignment of the approaches include but are not limited to the following:

- Changing the inscribed circle diameter
- Offsetting the approach centerline to the left of the center of the roundabout
- Reducing entry widths and entry radii

Exhibit 6-11

Angle between Legs

possible. Y-shaped intersection alignments have the potential for higher speeds than desired. Approaches that intersect at angles greater than approximately 105° can be realigned by introducing curvature in advance of the roundabout to produce a more perpendicular intersection. Other possible geometric modifications include changes to the inscribed circle diameter or modifications to the shape of the central island to manage vehicle speeds. For roundabouts in low-speed urban environments, the alignment of the approaches may be less critical.

6.4 SINGLE-LANE ROUNDABOUTS

This section presents specific parameters and guidelines for the design of individual geometric elements at a single-lane roundabout. Many of these same principles also apply to the design of multilane roundabouts; however, there are some additional complexities to the design of multilane roundabouts that are described in detail in Section 6.5. Individual geometric components are not independent of each other; the interaction between the components of the geometry is more important than the individual pieces. Care must be taken to provide compatibility between the geometric elements to meet overall safety and capacity objectives.

Once an initial inscribed diameter, roundabout location, and approach alignment are identified, the design can be more fully developed to include establishing the entry widths, circulatory roadway width, and initial entry and exit geometry. These additional details are described within this section. Once the initial designs for the entries and exits on each approach have been laid out, performance checks should be undertaken to evaluate the design versus the principles (including fastest path and design vehicle accommodation) to identify any required design refinements. Based on the performance checks, it may be necessary to perform design iterations to adjust the inscribed circle diameter, approach alignments, roundabout location, and/or entry and exit design to improve the composition of the design.

6.4.1 SPLITTER ISLANDS

Splitter islands (also called *separator islands*, *divisional islands*, or *median islands*) should be provided on all single-lane roundabouts. Their purpose is to provide refuge for pedestrians, assist in controlling speeds, guide traffic into the roundabout, physically separate entering and exiting traffic streams, and deter wrong-way movements. Additionally, splitter islands can be used as a place for mounting signs (see Chapter 7).

When performing the initial layout of a roundabout's design, a sufficiently sized splitter island envelope should be identified prior to designing the entry and exits of an approach. This will ensure that the design will eventually allow for a raised island that meets the minimum dimensions (offsets, tapers, length, widths). It is recommended that control points for the splitter island envelope be identified prior to proceeding to the design of the entry and exit geometry to ensure that a properly sized splitter island will be provided.

The total length of the raised island should generally be at least 50 ft (15 m), although 100 ft (30 m) is desirable, to provide sufficient protection for pedestrians and to alert approaching drivers to the geometry of the roundabout. On higher speed roadways, splitter island lengths of 150 ft (45 m) or more are often beneficial. Additionally, the splitter island should extend beyond the end of the exit curve to prevent exiting traffic from accidentally crossing into the path of approaching traffic. The splitter island width should be a minimum of 6 feet (1.8 m) at the crosswalk to adequately provide refuge for pedestrians, including those using wheelchairs, pushing a stroller, or walking a bicycle.

Splitter islands perform multiple functions and should be provided.

The recommended minimum length for a splitter island is 50 ft to provide adequate visibility and refuge.

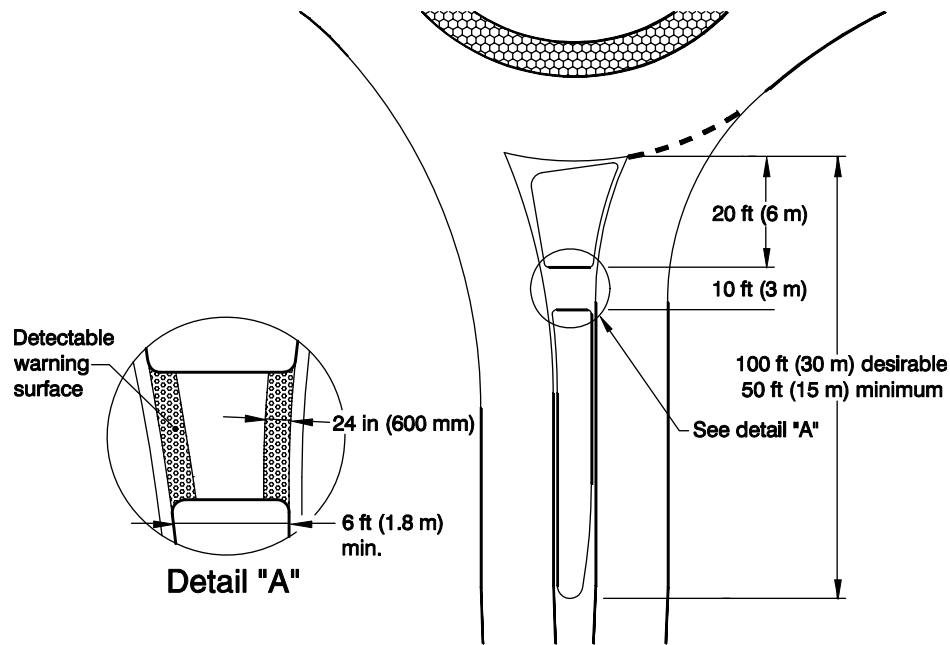

Exhibit 6-12
Minimum Splitter Island
Dimensions

Exhibit 6-12 shows the minimum dimensions for a splitter island at a single-lane roundabout, including the location of the pedestrian crossing.

While the above diagram provides minimum dimensions for splitter islands, there are benefits to providing larger islands. An increase in the splitter island width results in greater separation between the entering and exiting traffic streams of the same leg and increases the time for approaching drivers to distinguish between exiting and circulating vehicles. In this way, larger splitter islands can help reduce confusion for entering motorists. A study by the Queensland Department of Main Roads found that maximizing the width of splitter islands has a significant effect on minimizing entering/circulating vehicle crash rates (3). However, increasing the width of the splitter islands generally requires increasing the inscribed circle diameter in order to maintain speed control on the approach. Thus, these safety benefits may be offset by higher construction cost and greater land impacts.

Standard AASHTO guidelines for island design should be followed for the splitter island. This includes using larger nose radii at approach corners to maximize island visibility and offsetting curb lines at the approach ends to create a funneling effect. The funneling treatment also aids in reducing speeds as vehicles approach the roundabout. Exhibit 6-13 shows typical minimum splitter island nose radii and offset dimensions from the entry and exit traveled ways.

Alternative splitter island designs have been adopted by some states to meet local design preferences or climate conditions. For instance, some states use features such as sloped approach noses, unique curb shapes, and specifications for sloping the top surface of the island outward. Local design standards should be followed in locations where more specific guidance has been adopted.

Use care during the initial design to provide a sufficiently large splitter island envelope that will allow for the final raised island to meet the minimum dimensions shown in Exhibit 6-12 and Exhibit 6-13.

Wide splitter islands enhance safety, but may require that the inscribed circle diameter be increased.

Exhibit 6-13
Typical Minimum Splitter
Island Nose Radii and Offsets

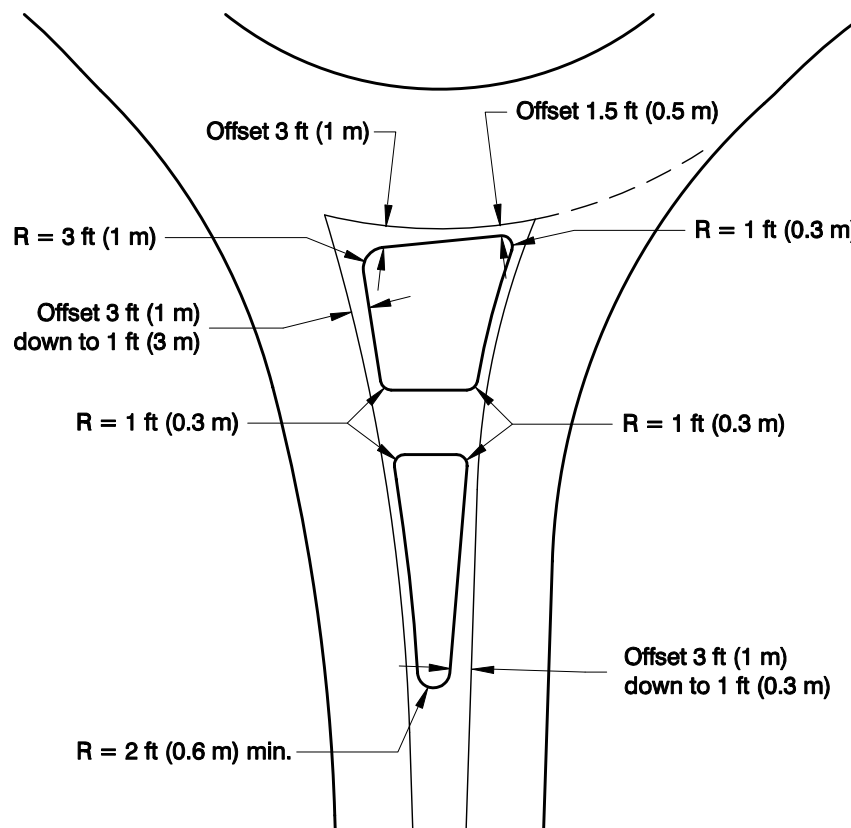

6.4.2 ENTRY WIDTH

Entry width is measured from the point where the entrance line intersects the left edge of traveled way to the right edge of the traveled way, along a line perpendicular to the right curb line. The width of each entry is dictated by the needs of the entering traffic stream, principally the design vehicle. However, this needs to be balanced against other performance objectives including speed management and pedestrian crossing needs.

Typical entry widths for single-lane entrances range from 14 to 18 ft (4.2 to 5.5 m); these are often flared from upstream approach widths. However, values higher or lower than this range may be appropriate for site-specific design vehicle and speed requirements for critical vehicle paths. A 15 ft (4.6 m) entry width is a common starting value for a single-lane roundabout. Care should be taken with entry widths greater than 18 ft or for those that exceed the width of the circulatory roadway, as drivers may mistakenly interpret the wide entry to be two lanes when there is only one receiving circulatory lane.

6.4.3 CIRCULATORY ROADWAY WIDTH

The required width of the circulatory roadway is determined from the number of entering lanes and the turning requirements of the design vehicle. Except opposite a right-turn-only lane, the circulating width should be at least as wide as the maximum entry width and up to 120% of the maximum entry width. For single-lane roundabouts, the circulatory roadway width usually remains constant

throughout the roundabout (9). Typical circulatory roadway widths range from 16 to 20 ft for single-lane roundabouts. Care should be taken to avoid making the circulatory roadway width too wide within a single-lane roundabout because drivers may think that two vehicles are allowed to circulate side-by-side.

At single-lane roundabouts, the circulatory roadway width should be comfortable for passenger car vehicles and should be wide enough to accommodate a design vehicle up to a bus at a small roundabout. There may be some operational benefit to accommodating a WB-50 (WB-15) within the circulatory roadway at a single-lane urban arterial roundabout to allow somewhat faster circulating speeds. A truck apron will often need to be provided within the central island to accommodate larger design vehicles (including the common WB-62 (WB-19), WB-65 (WB-20), or WB-67 (WB-20) design vehicles) but maintain a relatively narrow circulatory roadway to adequately constrain vehicle speeds. Additional discussion of truck aprons is provided in Section 6.4.7.1. Appropriate templates or a CAD-based computer program should be used to determine the swept path of the design vehicle through each of the turning movements. Usually, the left-turn movement is the critical path for determining circulatory roadway width. In accordance with AASHTO policy, a minimum clearance of 1 ft (0.3 m) and preferably 2 ft (0.6 m) should be provided between the outside edge of the vehicle's tire track and the curb line.

6.4.4 CENTRAL ISLAND

The central island of a roundabout is the raised, mainly non-traversable area surrounded by the circulatory roadway. It may also include a traversable truck apron. The island is typically landscaped for aesthetic reasons and to enhance driver recognition of the roundabout upon approach. Raised central islands for single-lane roundabouts are preferred over depressed central islands, as depressed central islands are difficult for approaching drivers to recognize and drainage can be an issue.

A circular central island is preferred because the constant-radius circulatory roadway helps promote constant speeds around the central island. Oval or irregular shapes, on the other hand, can promote higher speeds on the flatter arc sections and reduced speeds on the tighter arc sections, depending on the lengths of those sections. However, oval shapes may be necessary at irregularly shaped intersections or intersections with more than four legs. Oval shapes are generally not such a problem if they are relatively small and speeds are low. Raindrop-shaped islands may be used in areas where certain movements do not exist, such as interchanges (see Section 6.10), or at locations where certain turning movements cannot be safely accommodated, such as roundabouts with one approach on a relatively steep grade.

The size of the central island plays a key role in determining the amount of deflection imposed on the through vehicle's path. However, its diameter is dependent upon the inscribed circle diameter and the required circulatory roadway width (see Sections 6.3.1 and 6.4.3, respectively). Roundabouts in rural environments typically need larger central islands than urban roundabouts to enhance their visibility, accommodate larger design vehicles, enable better approach geometry to be designed in the transition from higher speeds, and be more forgiving to errant vehicles (3).

Circular central islands are preferable to oval or irregular shapes, but noncircular shapes are sometimes necessary.

Raindrop-shaped central islands may be used where certain movements do not exist, such as at interchanges.

Landscaping and other treatments within the central island are discussed in Chapter 8.

6.4.5 ENTRY DESIGN

As shown in Exhibit 6-14, the entry is bounded by a curb or edge of pavement consisting of one or more curves leading into the circulatory roadway. It should not be confused with the *entry path curve*, defined by the fastest vehicular travel path through the entry geometry (measured by R_1 in 6). At single-lane roundabouts, a single entry curb radius is typically adequate; for approaches on higher speed roadways, the use of compound curves may improve guidance by lengthening the entry arc.

Exhibit 6-14
Single-Lane Roundabout
Entry Design

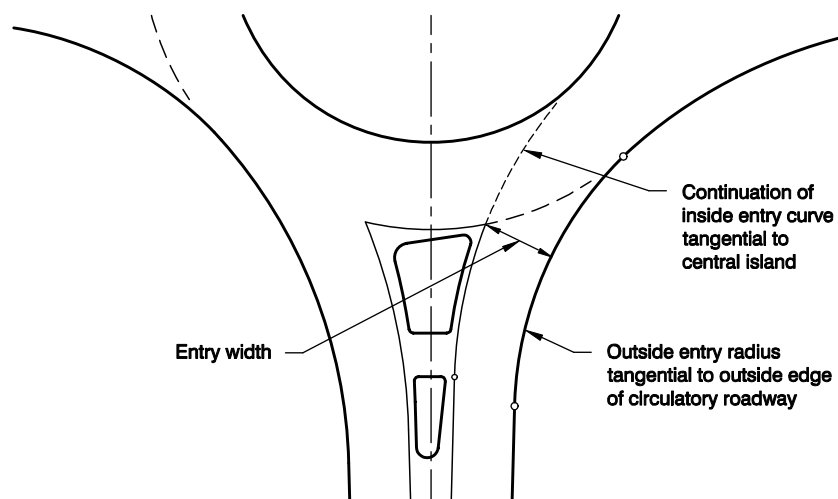

The entry curb radius is an important factor in determining the operation of a roundabout because it affects both capacity and safety. The entry curb radius, in conjunction with the entry width, the circulatory roadway width, and the central island geometry, controls the amount of deflection imposed on a vehicle's entry path. Excessively large entry curb radii have a higher potential to produce faster entry speeds than desired. Care should also be taken to avoid entry curb radii that are too abrupt since these may lead to single-vehicle crashes. Guidance from the United Kingdom indicates that small entry curb radii, below 50 ft (15 m), may reduce the capacity of the entry; however, entry curb radii that are 65 ft (20 m) or greater have little effect on the roundabout capacity (9, 10). Anecdotally, larger entry curb radii may allow for higher speeds and therefore could increase the entry capacity under low conflicting flow rates.

As with the other components of a roundabout design, a wide range of entry curb radii may be appropriate depending upon the other components of the design. The primary goal in selecting the entry curb radius is to achieve the speed objectives, as described in Section 6.2. The entry curb radius should produce an appropriate design speed on the fastest vehicular path. At single-lane roundabouts, it is relatively simple to achieve the entry speed objectives. With a single traffic stream entering and circulating, there is no conflict between traffic in adjacent lanes. Thus, the entry curb radius can be reduced or increased as necessary to produce the

desired entry path radius. Provided sufficient clearance is given for the design vehicle, approaching vehicles will adjust their path accordingly and negotiate through the entry geometry into the circulatory roadway. The outside curb line of the entry is commonly designed curvilinearly tangential to the outside edge of the circulatory roadway. Likewise, the projection of the inside (left) edge of the entry roadway is commonly curvilinearly tangential to the central island. Exhibit 6-14 shows a typical single-lane roundabout entrance design.

Entry radii at urban single-lane roundabouts typically range from 50 to 100 ft (15 to 30 m). A common starting point is an entry radius in the range of 60 to 90 ft; however, a larger or smaller radius may be needed to accommodate large vehicles or serve small diameter roundabouts, respectively. Larger radii may be used, but it is important that the radii not be so large as to result in excessive entry speeds.

The entry geometry should provide adequate horizontal curvature to channelize drivers into the circulatory roadway to the right of the central island. It is also often desirable for the splitter island to have enough curvature to block a direct path to the central island for approaching vehicles. This helps to avoid vehicles errantly hitting the central island and also further discourages drivers from making a wrong-way left-turn maneuver. Exhibit 6-16 illustrates an alternative method for increasing the amount of entry deflection.

Another important principle in the design of an entry is sight distance and visibility, as discussed in Section 6.2.6. The angle of visibility to the left must be adequate for entering drivers to comfortably view oncoming traffic from the immediate upstream entry or from the circulatory roadway. Additional details on measuring angles of visibility are provided in Section 6.7.4. A useful surrogate used by some practitioners for capturing the effects of entry speed, path alignment, and visibility to the left is entry angle (ϕ). Typical entry angles are between 20° and 40° . Additional detail on entry angle can be found in the Wisconsin Department of Transportation Roundabout Guide (7) and design guidance from the United Kingdom (9–10). In general, entry angles that are too severe produce poor angles of visibility to the left, requiring drivers to strain to look over their shoulders, and may encourage merging behavior similar to freeway on-ramps. Meanwhile entry angles that are too shallow may not provide enough positive alignment to discourage wrong-way movements.

At rural and suburban locations, consideration should be given to the speed differential between the approaches and entries. If the difference is greater than 12 mph (20 km/h), it may be desirable to introduce geometric or cross-sectional features to reduce the speed of approaching traffic prior to the entry curvature. Further details on roundabout design in high-speed environments are provided in Section 6.8.

6.4.6 EXIT DESIGN

The exit curb radii are usually larger than the entry curb radii in order to minimize the likelihood of congestion and crashes at the exits. This, however, is balanced by the need to maintain slow speeds through the pedestrian crossing on exit. The exit design is also influenced by the design environment (urban versus rural), pedestrian demand, the design vehicle, and physical constraints.

The exit curb is commonly designed to be curvilinearly tangential to the outside edge of the circulatory roadway. Likewise, the projection of the inside (left) edge of the exit roadway is commonly curvilinearly tangential to the central island. Generally, exit curb radii should be no less than 50 ft (15 m), with values of 100 to 200 ft (30 to 60 m) being more common. Exhibit 6-15 shows a typical exit layout for a single-lane roundabout.

Exhibit 6-15
Single-Lane Roundabout
Curvilinear Exit Design

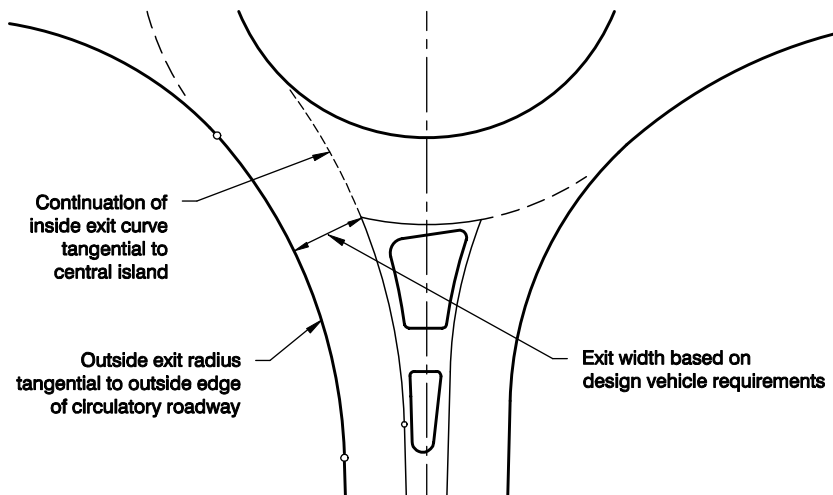

For designs using an offset-left approach alignment, the exit design may require much larger radii, ranging from 300 to 800 ft (91 to 244 m) or greater (11). Larger exit radii may also be desirable in areas with high truck volumes to provide ease of navigation for trucks and reduce the potential for trailers to track over the outside curb (see Exhibit 6-19). These radii may provide acceptable speed through the pedestrian crossing area given that the acceleration characteristics of the vehicles will result in a practical limit to the speeds that can be achieved on the exit. However, the fastest-path methodology presented in Section 6.7 can be used to verify the exit speed. A large-radius or tangential type exit design is illustrated in Exhibit 6-16.

Exhibit 6-16
Single-Lane Roundabout
Large Radius Exit Design

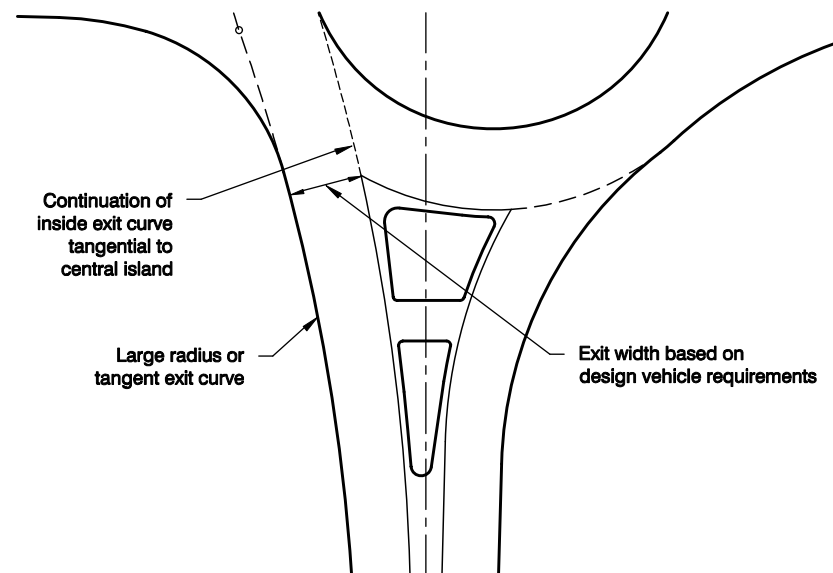

At single-lane roundabouts in urban environments, exits should be designed to enforce slow exit path speeds to maximize safety for pedestrians crossing the exiting traffic stream. Pedestrian activity should be considered at all exits except where separate pedestrian facilities (grade separated paths, etc.) or other restrictions eliminate the likelihood of pedestrian activity in the foreseeable future.

Similar to entry design, exit design flexibility is required to achieve the optimal balance between competing design variables and project objectives to provide adequate capacity and essential safety (for all modes) while minimizing excessive property impacts and costs. The selection of a curved versus tangential design will be based upon the balancing of each of these criteria.

6.4.7 DESIGN VEHICLE CONSIDERATIONS

Within a single-lane roundabout, the design vehicle is typically the controlling factor for most dimensions, including the inscribed circle diameter, entry width, entry radius, and circulatory roadway width. Exhibit 6-17 and Exhibit 6-18 demonstrate the use of a CAD-based computer program to determine the vehicle's swept path through the critical turning movements.

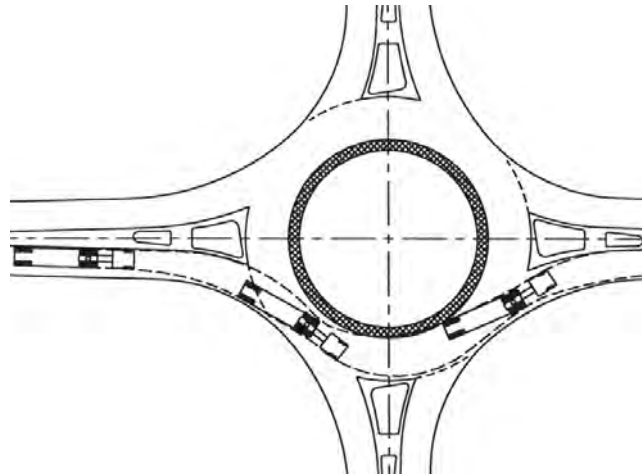

Exhibit 6-17
Through Movement Swept
Path of WB-50 (WB-15)
Vehicle

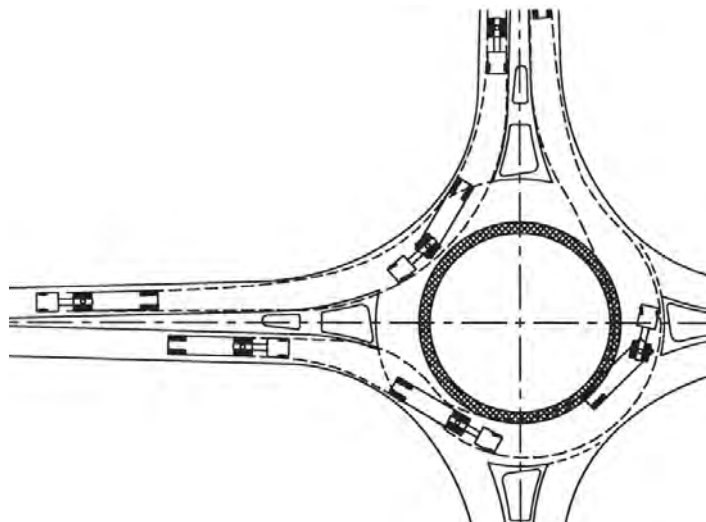

Exhibit 6-18
Turning Movement Swept
Paths of WB-50 (WB-15)
Vehicle

Roundabouts: An Informational Guide

Larger-diameter roundabouts may be required to accommodate large vehicles while maintaining low speeds for passenger vehicles. However, in some cases, land constraints may limit the ability to accommodate large semi-trailer combinations while achieving adequate deflection for small vehicles. In such situations, a truck apron may be used to provide additional traversable area around the central island for large semi-trailers. Where provided, truck aprons should be designed with a curbed edge high enough to discourage passenger vehicles from traversing over the top of the apron. Additional discussion is provided in Section 6.8.7.

Passenger buses should be accommodated within the circulatory roadway without tracking over the truck apron, which could jostle bus occupants.

The location of the roundabout may dictate the use of specific design vehicles. Recreational routes are often frequented by motor homes and other recreational vehicles. Agricultural areas are frequented by tractors, combines, and other farm machinery. Manufacturing areas may see oversize trucks. Each of these special design vehicles should be incorporated very early into the design process since they can affect the fundamental design decisions of size, position, and alignment of approaches.

It may occasionally be appropriate to choose a smaller design vehicle for turning movements but a larger design vehicle for through movements. For example, in dense urban areas where right-of-way is at a premium, it may be reasonable to design so that single unit trucks and buses can easily make left turns, right turns, and through movements, but WB-50 vehicles and larger can only travel straight through the roundabout. For example, this design technique could be acceptable where large trucks travel along the major roadway but are prohibited from traveling along the cross street. This technique should be used with caution due to the fact that if applied inappropriately, it could result in trucks off-tracking into pedestrian areas, landscape areas, signs, or street furniture (see Exhibit 6-19).

Oversized vehicles are vehicles that typically require special permits due to their extreme weight and size. Engineers should inquire whether the route may potentially carry oversized vehicles and have to incorporate the needs of those vehicles in the design. Roundabouts should generally not be designed to provide normal circulation using an oversized truck as the design vehicle since this will result in excessive dimensions and higher speeds for the majority of users. Where oversized vehicles can be reasonably anticipated, the truck apron and central island design may need to be modified to accommodate the larger vehicles.

Exhibit 6-19
Vehicle Over-Tracking
from Inadequate Entry
and Exit Design



(a) Entry over-tracking

(b) Exit over-tracking

For locations with a high volume of truck traffic, special consideration may be given to the size of the roundabout to require use of the truck apron by only the largest of vehicles. For the example illustrated in Exhibit 6-20, the high volume of truck traffic traversing through the intersection dictated the use of a larger inscribed circle diameter. This larger diameter provides a greater ease of movement for large vehicles and minimizes the widths for the entries, exits, and circulatory roadway. While the design dimensions chosen for this roundabout were appropriate for the environmental context and design vehicle, the diameter of the roundabout should generally be kept to a minimum.



Florence, Kansas

Exhibit 6-20
Roundabout with High
Volume of Heavy Vehicles

6.4.7.1 Truck Aprons

A traversable truck apron is typical for most roundabouts to accommodate large vehicles while minimizing other roundabout dimensions. A truck apron provides additional paved area to allow the over-tracking of large semi-trailer vehicles on the central island without compromising the deflection for smaller vehicles. The width of the truck apron is defined based upon the swept path of the design vehicle. As described under Section 6.4.3, the circulatory roadway should typically be designed to accommodate a bus design vehicle. Therefore, any larger design vehicle would be expected to use the truck apron for accommodating the vehicle tracking.

Truck aprons should be designed such that they are traversable to trucks but discourage passenger vehicles from using them. Truck apron width is dictated by the tracking of the design vehicle using templates or CAD-based vehicle-turning-path simulation software. They should generally be 3 to 15 ft (1 to 4.6 m) wide and have a cross slope of 1% to 2% away from the central island. To discourage use by passenger vehicles, the outer edge of the apron should be raised approximately 2 to 3 in. (50 to 75 mm) above the circulatory roadway surface. The apron should be constructed of a different material than the pavement to differentiate it from the circulatory roadway. Care must be taken to ensure that delivery trucks will not experience load shifting as their rear trailer wheels track across the apron.

As illustrated in Exhibit 6-21, a wider truck apron is often required to accommodate a left-turning vehicle at a roundabout with a smaller inscribed circle diameter. This limits the amount of landscaping that can be provided, which may

 Roundabouts: An Informational Guide

Exhibit 6-21
Comparison of Swept Paths
for a WB-67 Design Vehicle
at Various Diameters



(a) Inscribed circle diameter of 125 ft (38 m)

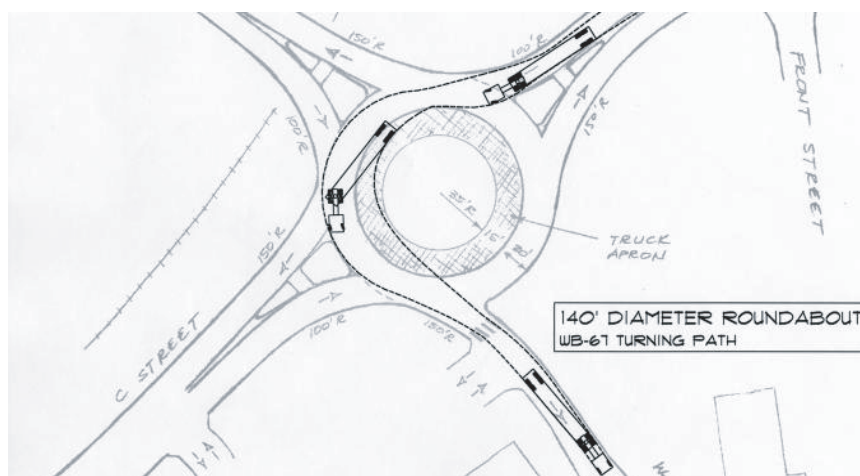

(b) Inscribed circle diameter of 140 ft (43 m)

in turn limit the visibility of the central island on the approach. Additionally, wider entries and larger entry radii are typically required for a small diameter roundabout to accommodate the design vehicle.

At single-lane roundabouts, the right-turn movement is often the controlling movement for the intersection. This is especially true for locations for skewed approach alignments (less than 90° angle between adjacent approach centerlines). To adequately accommodate the design vehicle, the corner radius (commonly a fillet between entry curve and adjacent exit curve) is frequently increased. This may result in a wide portion of circulatory roadway between the subject entrance and adjacent exit. This wide area is often striped out or an outside truck apron is provided. Both of these options are generally undesirable, although they may be considered under constrained situations. Alternative improvements to consider prior to implementing an outside truck apron include realigning the approaches to be more perpendicular, providing an offset-left alignment on the entry to improve the radius for truck turning, increasing the inscribed circle diameter, or providing a right-turn bypass.

Aesthetic features can be added to the truck apron that enhance the landscaping of the central island. The material used for the truck apron should be different than

the material used for the sidewalks so that pedestrians are not encouraged to cross the circulatory roadway. In addition, the truck apron features should be designed to encourage heavy vehicles to use this portion of the central island when necessary. If the colored or textured pavement appears to be for aesthetics only, truck drivers may be discouraged to traverse the apron (12). Exhibit 6-22 illustrates an example of applying aesthetic pavement treatments to the truck apron. Some agencies have used waffle block material as part of the truck apron, as shown in Exhibit 6-23. This provides additional truck apron width for the occasional large vehicle without adding additional impervious area.



(a) Arcata, California



(b) Santa Barbara, California



Killingworth, Connecticut

Exhibit 6-22

Example of Aesthetic Truck Apron Treatments

Exhibit 6-23

Example of Waffle Blocks Used within a Truck Apron

6.5 MULTILANE ROUNDABOUTS

The principles and design process described previously apply to multilane roundabouts but in a more complex way. Because multiple traffic streams may enter, circulate through, and exit the roundabout side-by-side, the engineer also should consider how these traffic streams interact with each other. The geometry of the roundabout should provide adequate alignment and establish appropriate lane configurations for vehicles in adjacent entry lanes to be able to negotiate the roundabout geometry without competing for the same space. Otherwise, operational and/or safety deficiencies may occur.

Multilane roundabout design tends to be less forgiving than single-lane roundabout design. Multilane design can have a direct impact on vehicle alignment and lane choice, which can affect both the safety performance and capacity. Capacity, safety, property impacts, and costs are interrelated, and a balance of these

components becomes more difficult with multilane roundabout design. Due to this balancing of design elements that is required to meet the design principles, the use or creation of boilerplate or standard designs is discouraged.

The design of pavement markings and signs at a multilane roundabout is also critical to achieving predicted capacities and optimal overall operations. Geometry, pavement markings, and signs must be designed together to create a comprehensive system to guide and regulate road users who are traversing roundabouts. The marking plan should be integral to the preliminary design phase of a project. Chapter 7 provides additional detail on the design of pavement markings and signs for multilane roundabouts.

In addition to the fundamental principles outlined in Section 6.2, other key considerations for all multilane roundabouts include:

- Lane arrangements to allow drivers to select the appropriate lane on entry and navigate through the roundabout without changing lanes,
- Alignment of vehicles at the entrance line into the correct lane within the circulatory roadway,
- Accommodation of side-by-side vehicles through the roundabout (i.e., a truck or bus traveling adjacent to a passenger car),
- Alignment of the legs to prevent exiting–circulating conflicts, and
- Accommodation for all travel modes.

The reader should also refer to Section 6.4 on single-lane roundabouts as some design elements [such as central islands (Section 6.4.4)] are not described again in this multilane roundabouts section because the information is not substantially different for multilane design. Section 6.8 also provides additional information pertaining to design of pedestrian and bicycle facilities.

6.5.1 LANE NUMBERS AND ARRANGEMENTS

Multilane roundabouts have at least one approach with at least two lanes on the entries or exits. The number of lanes can vary from approach to approach as long as they are appropriately assigned by lane designation signs and markings. Likewise, the number of lanes within the circulatory roadway may vary depending upon the number of entering and exiting lanes. The important principle is that the design requires continuity between the entering, circulating, and exiting lanes such that lane changes are not needed to navigate the roundabout. The driver should be able to select the appropriate lane upstream of the entry and stay within that lane through the roundabout to the intended exit without any lane changes. This principle is consistent with the design of all types of intersections.

The number of lanes provided at the roundabout should be the minimum needed for the existing and anticipated demand as determined by the operational analysis. The engineer is discouraged from providing additional lanes that are not needed for capacity purposes as these additional lanes can reduce the safety effectiveness at the intersection. If additional lanes are needed for future conditions, a phased design approach should be considered that would allow for future expansion.

On multilane roundabouts, it is also desirable to achieve balanced lane utilization in order to be able to achieve predicted capacity. There are a number of design variables that can produce lane imbalance, such as poorly designed entry or exit alignments or turning movement patterns. There is also a need to recognize possible downstream system variables, such as a major trip generator, interchange ramp, or bottleneck at a downstream intersection. All of these variables may influence lane choice at a roundabout.

6.5.2 ENTRY WIDTH

The required entry width for any given design is dependent upon the number of lanes and design vehicle. A typical entry width for a two-lane entry ranges from 24 to 30 ft (7.3 to 9.1 m) for a two-lane entry and from 36 to 45 ft (11.0 to 13.7 m) for a three-lane entry. Typical widths for individual lanes at entry range from 12 to 15 ft (3.7 to 4.6 m). The entry width should be primarily determined based upon the number of lanes identified in the operational analysis combined with the turning requirements for the design vehicle. Excessive entry width may not produce capacity benefits if the entry width cannot be fully used by traffic.

For locations where additional entry capacity is required, there are generally two options:

1. Adding a full lane upstream of the roundabout and maintaining parallel lanes through the entry geometry; or
2. Widening the approach gradually (flaring) through the entry geometry.

Exhibit 6-24 and Exhibit 6-25 illustrate these two widening options.

Approach flaring may provide an effective means of increasing capacity without requiring as much right-of-way as a full lane addition. In addition, U.K. research suggests that length of flare affects capacity without a direct effect on safety. Although this research has not been replicated in the United States, the U.K. findings suggest that the crash frequency for two approaches with the same entry width will be identical whether they have parallel entry lanes or flared entry

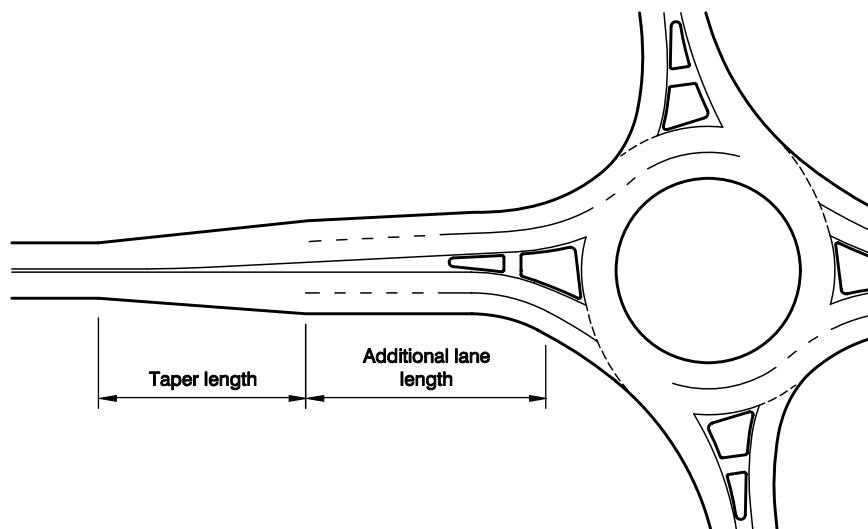
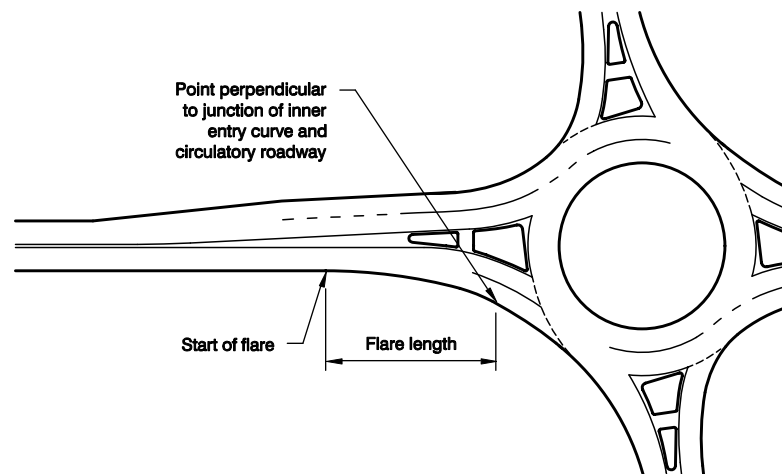

Exhibit 6-24
Approach Widening by Adding
a Full Lane

Exhibit 6-25
Approach Widening
by Entry Flaring



designs. Entry widths should therefore be minimized and flare lengths maximized to achieve the desired capacity with minimal effect on crashes.

6.5.3 CIRCULATORY ROADWAY WIDTHS

The circulatory roadway width is usually governed by the design criteria relating to the types of vehicles that may need to be accommodated adjacent to one another through a multilane roundabout. The provision of pavement markings within the circulatory roadway (discussed in Chapter 7) may require extra space and the use of a truck apron to support lane discipline for trucks and cars circulating. The combination of vehicle types to be accommodated side-by-side is dependent upon the specific site traffic conditions, and requirements for side-by-side design vehicles may vary by individual state or local jurisdiction. Further research on this topic is underway at the time of this publication, and the reader is advised to look to the latest guidance for the conditions being explored.

If the entering traffic is predominantly passenger cars and single-unit trucks (AASHTO P and SU design vehicles, respectively), where semi-trailer traffic is infrequent, it may be appropriate to design the width for two passenger vehicles or a passenger car and a single-unit truck side-by-side. If semi-trailer traffic is relatively frequent (greater than 10%), it may be necessary to provide sufficient width for the simultaneous passage of a semi-trailer in combination with a P or SU vehicle.

Multilane circulatory roadway lane widths typically range from 14 to 16 ft (4.3 to 4.9 m). Use of these values results in a total circulating width of 28 to 32 ft (8.5 to 9.8 m) for a two-lane circulatory roadway and 42 to 48 ft (12.8 to 14.6 m) total width for a three-lane circulatory roadway.

At multilane roundabouts, the circulatory roadway width may also be variable depending upon the number of lanes and the design vehicle turning requirements. A constant width is not required throughout the entire circulatory roadway, and it is desirable to provide only the minimum width necessary to serve the required lane configurations within that specific portion of the roundabout. A common combination is two entering and exiting lanes along the major roadway, but only single entering and exiting lanes on the minor street. This combination is illustrated in Exhibit 6-26. In this example, the portion of circulatory roadway that serves the

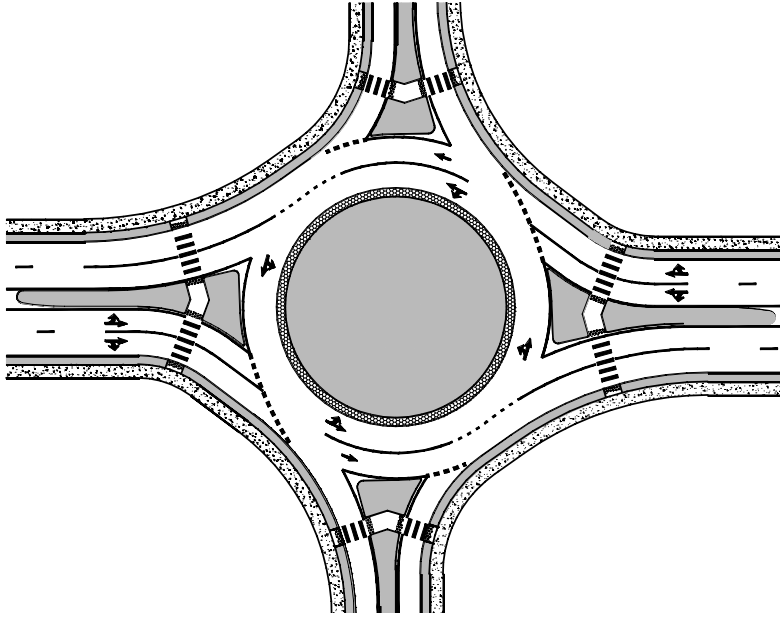
**Exhibit 6-26**

Multilane Major Street with
Single Lane on Minor Street

minor street has been reduced to a single lane to provide consistency in the lane configurations. For the portions of a multilane roundabout where the circulatory roadway is reduced to a single lane, the guidance for circulatory roadway width contained in Section 6.4.3 should be used.

In some instances, the circulatory roadway width may actually need to be wider than the corresponding entrance that is feeding that portion of the roundabout. For example, in situations where two consecutive entries require exclusive left turns, a portion of the circulatory roadway will need to contain an extra lane and spiral markings to enable all vehicles to reach their intended exits without being trapped or changing lanes. This situation is illustrated in Exhibit 6-27,

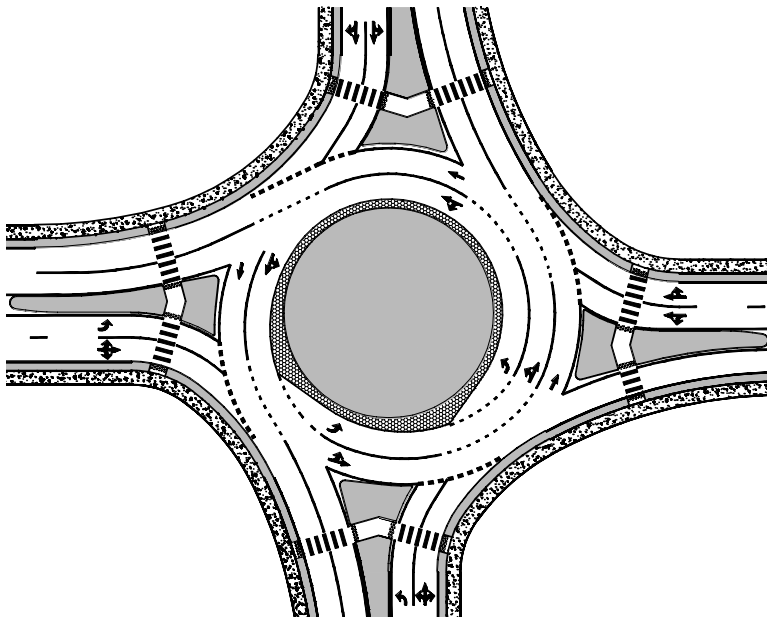
**Exhibit 6-27**

Two-Lane Roundabout with
Consecutive Double-Lefts

where a portion of the circulatory roadway is required to have three lanes despite the fact that all of the entries have only two lanes.

6.5.4 ENTRY GEOMETRY AND APPROACH ALIGNMENT

At multilane roundabouts, the design of the entry curvature should balance the competing objectives of speed control, adequate alignment of the natural paths, and the need for appropriate visibility lines. This often requires several iterations of design to identify the appropriate roundabout size, location, and approach alignments.

Individual geometric parameters also play a role in the balanced entry design. For example, entry radii are one key parameter that is often used to control vehicle speeds. The use of small entry radii may produce low entry speeds but often leads to path overlap on the entry since vehicles will cut across lanes to avoid running into the central island. Small entry radii may also result in an increase in single-vehicle crashes onto the central island.

Entry radii for multilane roundabouts should typically exceed 65 ft (20 m) to encourage adequate natural paths and avoid sideswipe collisions on entry. Engineers should avoid the use of overly tight geometrics in order to achieve the fastest-path objectives. Overly small [less than 45 ft (13.7 m)] entry radii can result in conflicts between adjacent traffic streams, which may result in poor lane use and reduced capacity. Similarly, the R_1 fastest-path radius should also not be excessively small. If R_1 is too small, vehicle path overlap may result, reducing the operational efficiency and increasing potential for crashes. Values for R_1 in the range of 175 to 275 ft (53 to 84 m) are generally preferable. This results in a design speed of 25 to 30 mph (40 to 50 km/h).

Vehicle path overlap is a type of conflict that occurs when the natural path of the adjacent lanes cross one another. It occurs most commonly at entries, where the geometry of the right (outside) lane tends to lead vehicles into the left (inside) circulatory lane. However, vehicle path overlap can also occur at exits where the geometry tends to lead vehicles from the left-hand lane into the right-hand exit lane. Exhibit 6-28 illustrates an example of entry vehicle path overlap.

Increasing vehicle path curvature decreases relative speeds between entering and circulating vehicles but also increases side friction between adjacent traffic streams in multilane roundabouts.

Exhibit 6-28
Entry Vehicle Path Overlap

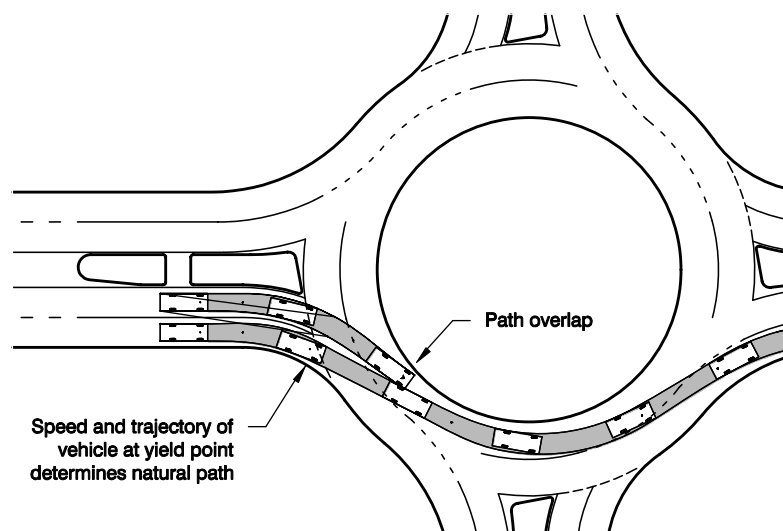

The engineer should balance the need to control entry speed with the need to provide good path alignment at multilane entries. The desired result of the entry design is for vehicles to naturally be aligned into their correct lane within the circulatory roadway, as illustrated in Exhibit 6-29. This can be done a variety of ways that can vary significantly depending on site-specific conditions. Therefore, it may not be possible to specify a single method for designing multilane roundabouts since this can preclude the needed flexibility in design. Regardless of the specific design technique employed, the engineer should maintain the overall design principles of speed management presented in Section 6.2.

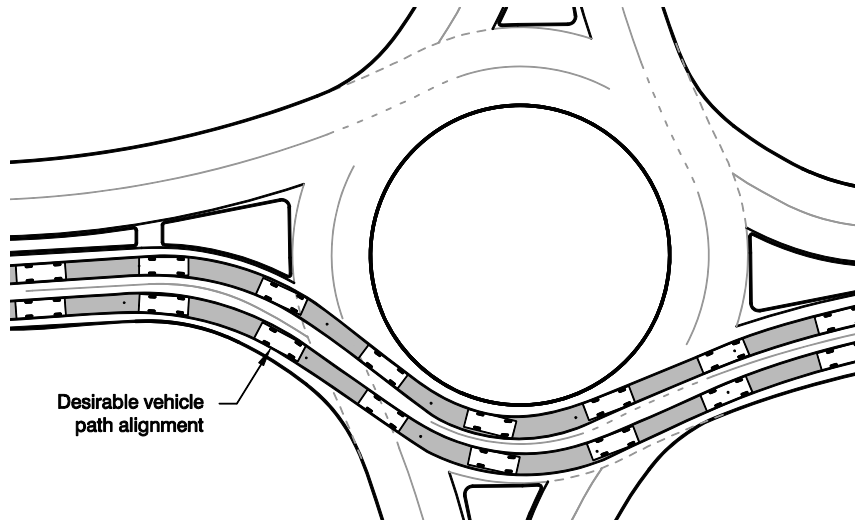

Exhibit 6-29
Desirable Vehicle Path Alignment

One possible technique to promote good path alignment is shown in Exhibit 6-30 using a compound curve or tangent along the outside curb. The design consists of an initial small-radius entry curve set back from the edge of the circulatory roadway. A short section of a large-radius curve or tangent is provided between the entry curve and the circulatory roadway to align vehicles into the proper circulatory lane at the entrance line. Care should be taken in determining the optimal location

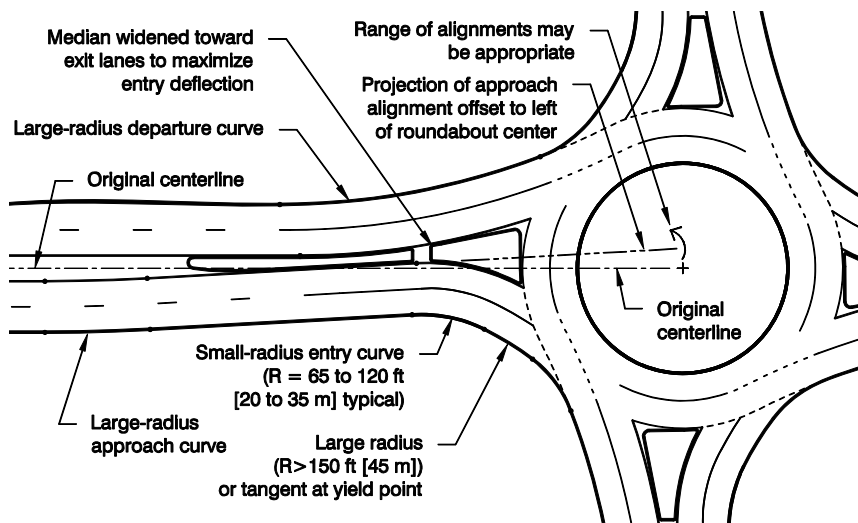

Exhibit 6-30
Example Minor Approach Offset to Increase Entry Deflection

of the entry curve from the entrance line. If it is located too close to the circulatory roadway, the tangent (or large radius portion of the compound curve) will be too short, and the design may still have path alignment issues. However, if the entry curve is located too far away from the circulatory roadway, it can result in inadequate deflection (i.e., entry speeds too fast).

For the method illustrated in Exhibit 6-30, entry curve radii commonly range from approximately 65 to 120 ft (20 to 35 m) and are set back at least 20 ft (6 m) from the edge of the circulatory roadway. A tangent or large-radius [greater than 150 ft (45 m)] curve is then fitted between the entry curve and the outside edge of the circulatory roadway.

An alternative method for designing the entry curves to a multilane roundabout is to use a single-radius entry curve rather than a small curve and tangent. This is similar in some regards to a single-lane design; however, larger radii are typically required to provide adequate vehicle alignment. Care must be taken when using a single entry curve to meet both the speed control and vehicle natural path alignment objectives. If the circulatory roadway is sufficiently wide relative to the entry, entry curves can be designed tangential to a design circle offset 5 ft (1.5 m) from the central island rather than to the central island. This improves the curvature and deflection that is achieved on the inside (splitter island) edge of the entry. Regardless of the method used, it is desirable for the inside (splitter island) curb to block the through path of the left lane to promote adequate deflection.

Another key factor in multilane roundabout design is to recognize that achieving adequate deflection on entry and meeting the principles is independent of the centerline of the approaching roadways. As discussed in Section 6.3, the centerlines of approach roadways do not need to pass through the center of the inscribed circle. It is acceptable design practice for multilane roundabouts to have an offset-left alignment, and in many cases this may provide a useful tool for achieving additional deflection and speed control.

Exhibit 6-31 illustrates an example of a design technique to enhance the entry deflection by shifting the approach alignment further toward the left of the roundabout center. This technique of offsetting the approach alignment left of the roundabout center is effective at increasing entry deflection. However, it also reduces the deflection of the exit on the same leg, where it is desirable to keep speeds relatively low within the pedestrian crosswalk location. Therefore, the distance of the approach offset from the roundabout center should be balanced with the other design objectives to maximize safety for pedestrians. Exhibit 6-32 illustrates an example of this technique being applied for a partial three-lane roundabout.

Other important components of the design of an entry are sight distance and visibility, as discussed in Section 6.2.6. The angle of visibility to the left must be adequate for entering drivers to comfortably view oncoming traffic from the immediate upstream entry or from the circulatory roadway. This requires that the vehicles be staggered at the entrance line such that vehicles nearest to the outside curb can see in front of the vehicle in the adjacent lane to the left of them. The design of the entry must balance the design objective of providing speed control with providing appropriate angles of visibility for drivers. Additional details on measuring angles of visibility are provided in Section 6.7.4.



Source: Wisconsin Department of Transportation (7)

Exhibit 6-31

Example of Major Approach Offset to Increase Entry Deflection

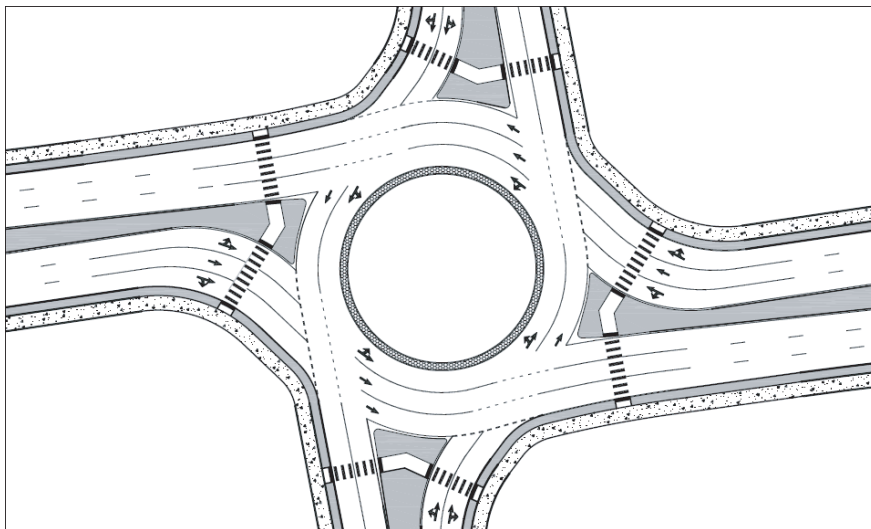

Exhibit 6-32

Example of a Partial Three Lane Roundabout with an Offset Approach Alignment

As discussed previously for single-lane roundabouts, a useful surrogate for capturing the effects of entry speed, path alignment, and visibility to the left is entry angle (ϕ). Typical entry angles are between 20° and 40° . Additional detail on entry angle can be found in the Wisconsin Department of Transportation *Roundabout Guide* (7) and design guidance from the United Kingdom (9, 10).

6.5.5 SPLITTER ISLANDS

For multilane roundabouts, the entry geometry is typically established first to identify a design that adequately controls fastest-path entry speeds, avoids entry path overlap, and accommodates the design vehicle. The splitter island is then developed in conjunction with the exit design to provide an adequate median width for the pedestrian refuge and for sign placement. Adequate median width should be provided to accommodate necessary equipment and pedestrian design elements where signalized pedestrian crossings are used. Additional details

regarding the minimum dimensions and design details for splitter islands are provided under the discussion of single-lane roundabouts in Section 6.4.1. Additional discussion of pedestrian crosswalk design is provided in Section 6.8.1 and considerations for signalized pedestrian crossing are discussed in Chapter 7.

6.5.6 EXIT CURVES

As with the entries, the design of the exit curvature at multilane roundabouts is more complex than at single-lane roundabouts. Conflicts can occur between exiting and circulating vehicles if appropriate lane assignments are not provided. Inadequate horizontal design of the exits can also result in exit vehicle path overlap, similar to that occurring at entries. The radii of exit curves are commonly larger than those used at the entry as a consequence of other factors (entry alignment, diameter, etc.); larger exit curve radii are also typically used to promote good vehicle path alignment. However, the design should be balanced to maintain low speeds at the pedestrian crossing at the exit.

To promote good path alignment at the exit, the exit radius at a multilane roundabout should not be too small. At single-lane roundabouts, it is acceptable to use a minimal exit radius in order to control exit speeds and maximize pedestrian safety. However, if the exit radius on a multilane exit is too small, traffic on the inside of the circulatory roadway will tend to exit into the outside exit lane on a more comfortable turning radius.

Problems can also occur when the design allows for too much separation between entries and subsequent exits. Large separations between legs causes entering vehicles to join next to circulating traffic that may be intending to exit at the next leg, rather than crossing the path of the exiting vehicles. This can create conflicts at the exit point between exiting and circulating vehicles, as shown in Exhibit 6-33.

Exhibit 6-33
Exit-Circulating Conflict
Caused by Large Separation
between Legs

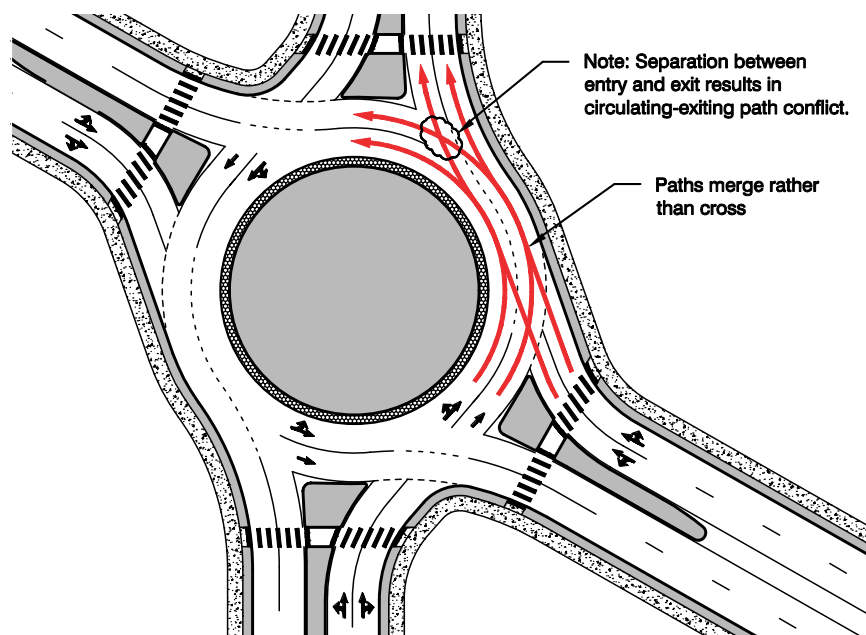

Source: California Department of Transportation (1)

Exhibit 6-34 illustrates a possible low-cost fix that involves modifications to the lane arrangements using a combination of striping and physical modifications. This may be acceptable if the traffic volumes are compatible. A better solution is illustrated in Exhibit 6-35, which involves realignment of the approach legs to have the paths of entering vehicles cross the paths of the circulating traffic (rather than merging) to eliminate the conflict.

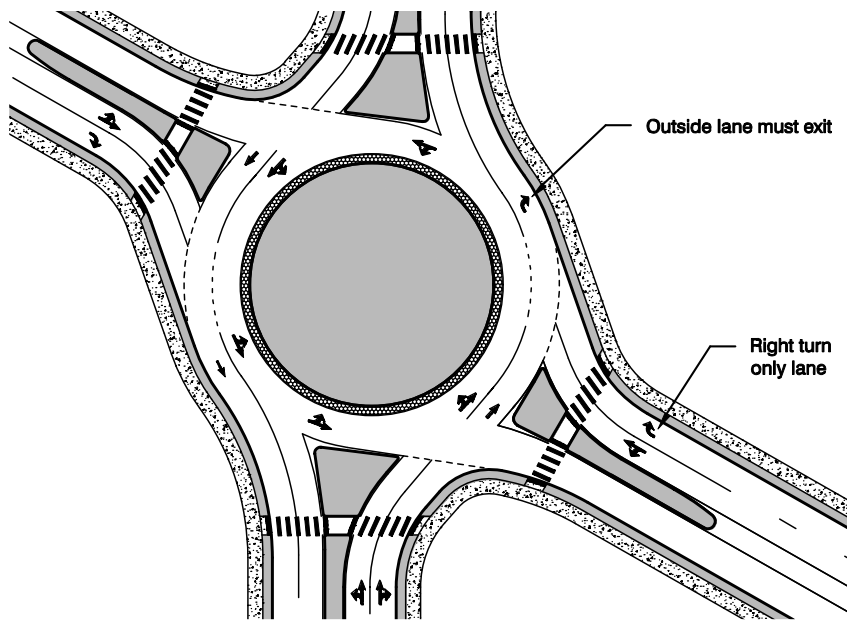

Exhibit 6-34
Possible Lane Configuration
Modifications to Resolve
Exit-Circulating Conflicts

Source: California Department of Transportation (1)

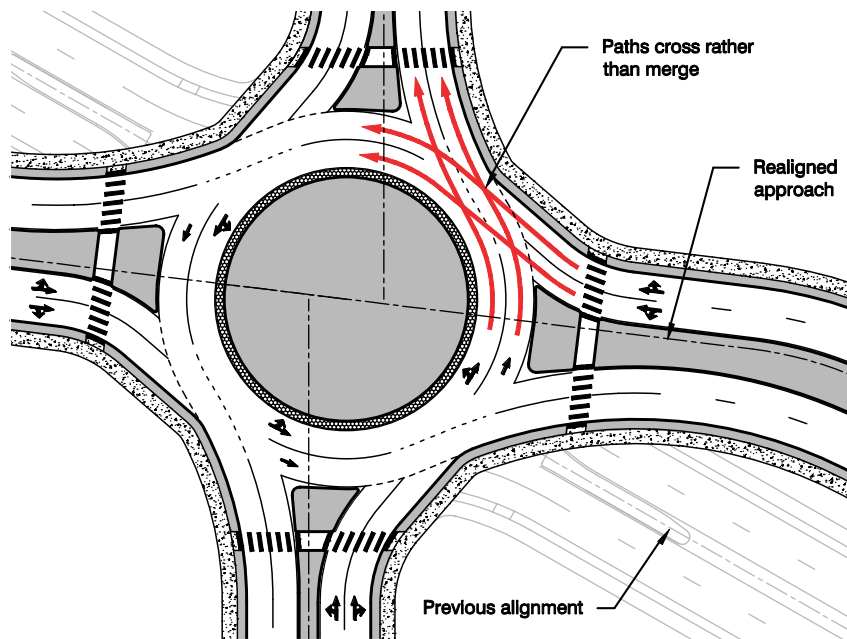

Exhibit 6-35
Realignment to Resolve
Exit-Circulating Conflicts

Source: California Department of Transportation (1)

6.5.7 DESIGN VEHICLE CONSIDERATIONS

Design vehicle considerations should be made for both tracking on the entry/exit and within the circulatory roadway (as previously discussed in Section 6.5.3). The percentage of trucks and lane utilization is an important consideration when determining whether the design will allow trucks to use two lanes or accommodate them to stay within their own lane. The frequency of a particular design vehicle is also an important consideration. For instance, a particular roundabout may have infrequent use by WB-67-size tractor-trailers and is thus designed to allow the WB-67 to claim both lanes to navigate through. However, the same location could have frequent bus service that would dictate the need to accommodate buses within their own lane to travel adjacent to a passenger car (see Exhibit 6-36). Therefore, a particular roundabout may have multiple design vehicles depending upon the unique site characteristics.

Exhibit 6-36
Side-by-Side Navigation for a
Bus and Passenger Car

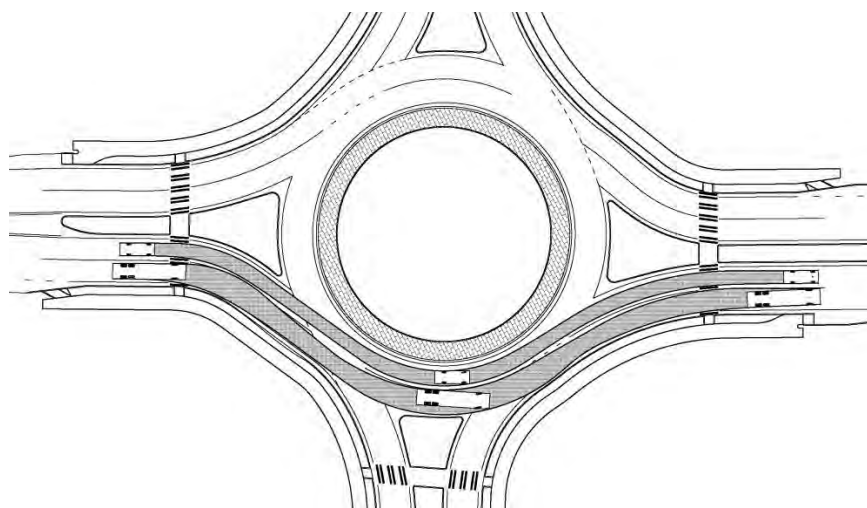

Where the design dictates the need to accommodate large design vehicles within their own lane, there are a number of design considerations that come into play. A larger inscribed circle diameter and entry/exit radii may be required to maintain speed control and accommodate the design vehicle. A technique that has been used in the United States on the entry is to provide gore striping—a striped vane island between the entry lanes—to help center the vehicles within the lane and allow a cushion for off-tracking by the design vehicle. This technique is illustrated in Exhibit 6-37. The actual dimensions used may vary depending on the individual design; however, one state (11) identified the use of two 12 ft (3.6 m) lanes and a 6 ft (1.8 m) wide gore area for an entrance with a total width of 30 ft (9 m).

Another technique for accommodating the design vehicle within the circulatory roadway is to use a wider lane width for the outside lane and a narrower lane width for the inside lane. For example, for a 32 ft (9.8 m) circulatory roadway width, an inside width of 15 ft (4.6 m) and an outside width of 17 ft (5.2 m) could be used. This would provide an extra two feet of circulating width for trucks in the outside lane. Large trucks in the inside lane would use the truck apron to accommodate any off-tracking. Eliminating all overlap for the outside lane may not always be desirable or feasible, as this may dictate a much larger inscribed circle diameter than desired for overall safety performance for all vehicle types and the context.

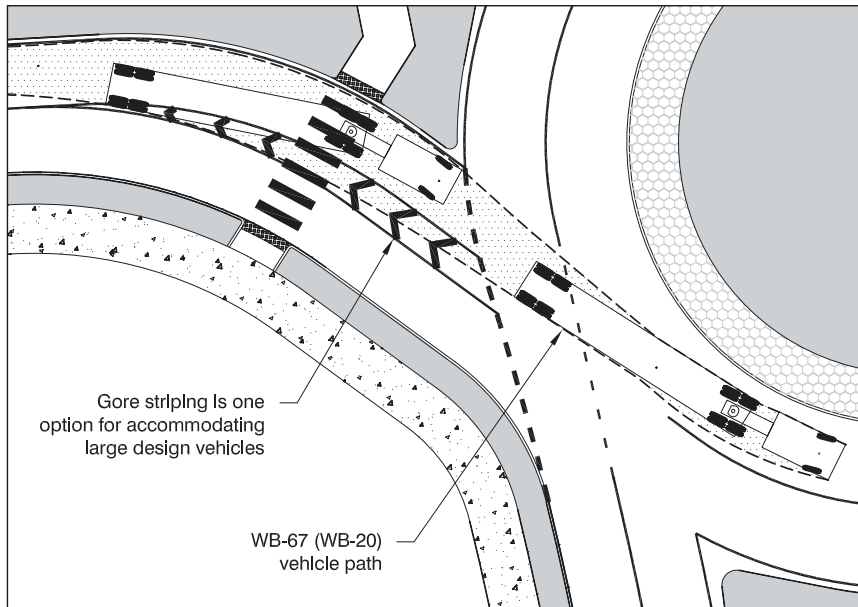

Source: New York State Department of Transportation (11)

Exhibit 6-37
WB-67 (WB-20) Truck Path
with Gore Striping at Entry

6.5.8 OTHER DESIGN PRACTICES

Throughout the world there continues to be advancement in the design practices for multilane roundabouts. One practice initiated in the Netherlands and being tested elsewhere is the turbo-roundabout (13). This style of multilane design has two key features that distinguish it from other multilane roundabouts:

- Entries are perpendicular to the circulatory roadway, and
- Raised lane dividers are used within the circulatory roadway to guide drivers to the appropriate exit.

This treatment has not been used in the United States at the time of this writing.

6.6 MINI-ROUNDBABOUTS

A mini-roundabout is an intersection design form that can be used in place of stop control or signalization at physically constrained intersections to help improve safety and reduce delays. Typically characterized by a small diameter and traversable islands, mini-roundabouts are best suited to environments where speeds are already low and environmental constraints would preclude the use of a larger roundabout with a raised central island. Exhibit 6-38 presents the characteristics of a mini-roundabout.

Mini-roundabouts operate in the same manner as larger roundabouts, with yield control on all entries and counterclockwise circulation around a central island. Due to the small footprint, large vehicles are typically required to travel over the fully traversable central island, as shown in Exhibit 6-38. To help promote safe operations, the design generally aligns passenger cars in such a way as

Exhibit 6-38
Basic Characteristics of
a Mini-Roundabout

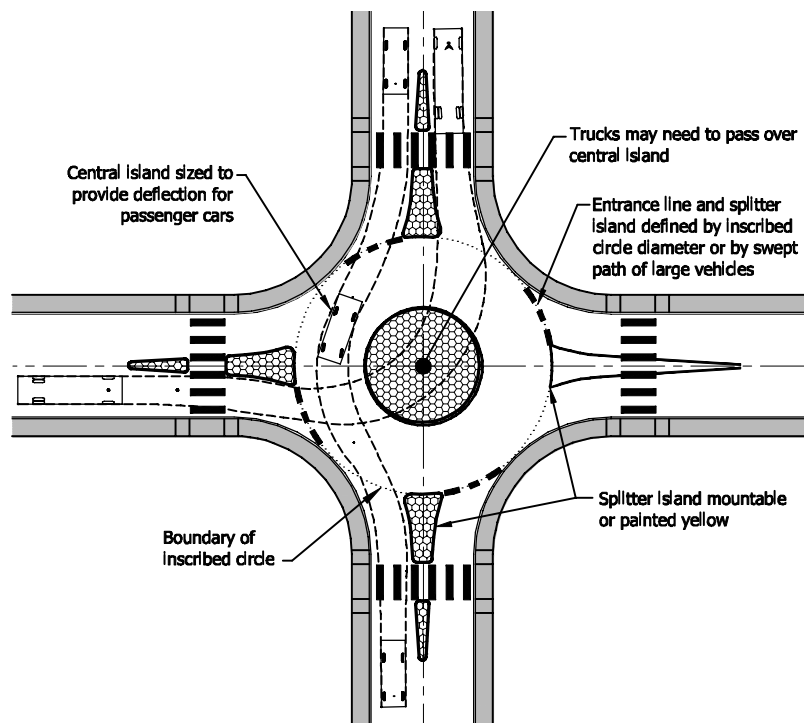

to naturally follow the circulatory roadway and minimize running over of the central island to the extent possible.

6.6.1 GENERAL DESIGN CRITERIA FOR MINI-ROUNDBABOUTS

Many of the same principles are used in the design of mini-roundabouts as in full-sized roundabouts. Key considerations include vehicle channelization, design vehicle paths, and intersection visibility. Given that the central island of a mini-roundabout is fully traversable, the overall design should provide channelization that naturally guides drivers to the intended path. Sub-optimum designs may result in drivers turning left in front of the central island (or driving over the top of it), improperly yielding, or traveling at excess speeds through the intersection.

A mini-roundabout is often considered as an alternative to a larger single-lane roundabout due to a desire to minimize impacts outside of the existing intersection footprint. Therefore, the existing intersection curb lines are a typical starting point for establishing the mini-roundabout inscribed circle diameter. Mini-roundabouts should be made as large as possible within the intersection constraints. However, a mini-roundabout inscribed circle diameter should generally not exceed 90 ft (30 m). Above 90 ft (30 m), the inscribed circle diameter is typically large enough to accommodate the design vehicles navigating around a raised central island. A raised central island provides physical channelization to control vehicle speeds, and therefore a single-lane design is preferred where a diameter greater than 90 ft (30 m) can be provided.

The fully traversable central island provides the clearest indication to the user that the intersection is a mini-roundabout. The location and size of a mini-roundabout's central island (and the corresponding width of the circulatory roadway) is dictated primarily by passenger car swept path requirements. The island

location should be at the center of the of the left-turning inner swept paths, which will be near, but not necessarily on, the center of the inscribed circle (14). The off-tracking of a large design vehicle should be accommodated by the footprint of the central island; meanwhile, passenger cars should be able to navigate through the intersection without being required to travel over the central island. As with single-lane and multilane roundabouts, it is desirable to also accommodate buses within the circulatory roadway to avoid jostling passengers by running over a traversable central island. However, for very small inscribed circle diameters, the bus turning radius is typically too large to navigate around the central island, thus requiring buses to travel over it. For mini-roundabouts with larger inscribed circle diameters, it may be possible to accommodate the swept path of a bus vehicle within the circulatory roadway. The potential trade-off to designing for a bus instead of a passenger car is that the design may result in a wider circulatory roadway and smaller central island.

The location of the central island should allow for all movements to be accommodated at the intersection with counterclockwise circulation. Designing the central island size and location to provide deflection through the roundabout will encourage proper circulation and reduced speeds through the intersection.

The central island is typically fully traversable and may either be domed or raised with a mountable curb and flat top for larger islands. Although painted central islands are commonly used in the UK, flush central islands are discouraged in other countries to maximize driver compliance. Composed of asphalt concrete, Portland cement concrete, or other paving material, the central island should be domed using 5% to 6% cross slope, with a maximum height of 5 in. (15). Although fully traversable and relatively small, it is essential that the central island be clear and conspicuous (15–16). Islands with a mountable curb should be designed in a similar manner to truck aprons on normal roundabouts.

The central island should be either delineated with a solid yellow line or completely covered with a yellow color. A yellow marking color is required by the MUTCD to provide consistency with other markings used where traffic typically travels to the right of the marking. If the entire center island is colored yellow, an anti-skid surface is recommended to increase surface friction and avoid slick surfaces, particularly for bicycles and motorcycles. A textured surface that provides a visible differentiation from the circulatory roadway may also be used, accompanied by a solid yellow line. In the United Kingdom, the center island must be marked in a solid white color to provide a uniform appearance and make the island conspicuous (17).

As described in Chapter 7, the edge line extension across the approach lane of roundabouts also serves as the entrance line. Two common options are used for placement of this line. One option is to place the entrance line at the outer edge of the inscribed circle diameter, common with the practice for single-lane and multi-lane roundabouts. Another option is to advance the entrance line toward the central island such that it is no longer coincident with the inscribed circle of the roundabout. The outer swept path of passenger cars and the largest vehicle likely to use the intersection is identified for all turning movements, and the advanced entrance line is placed at least 2 ft (0.6 m) outside of the vehicle paths. Skewed approaches are one particular situation where advancing the yield line may be

The central island of a mini-roundabout should be clear and conspicuous.

beneficial to discourage vehicles from making a left turn in front of the central island. However, this may result in a reduction of capacity since advancing the yield line may affect yielding behavior at the entry.

Exhibit 6-39 illustrates one particular situation where the design allows passenger cars to turn left in front of the central island. In this case, the combination of the intersection skew angle, small size of the central island, small size of the splitter islands, and large width of the circulatory roadway makes it comfortable for a driver to turn left in front of the central island instead of navigating around it. Three possible design improvements are illustrated in Exhibit 6-40. These include (1) advancing the yield line forward, (2) simultaneously enlarging the central island and reducing the circulatory roadway width, and (3) enlarging the inscribed circle diameter.

Exhibit 6-39
Design That Allows Left Turns
in Front of Central Island

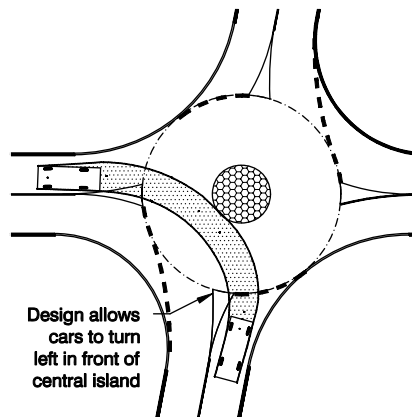
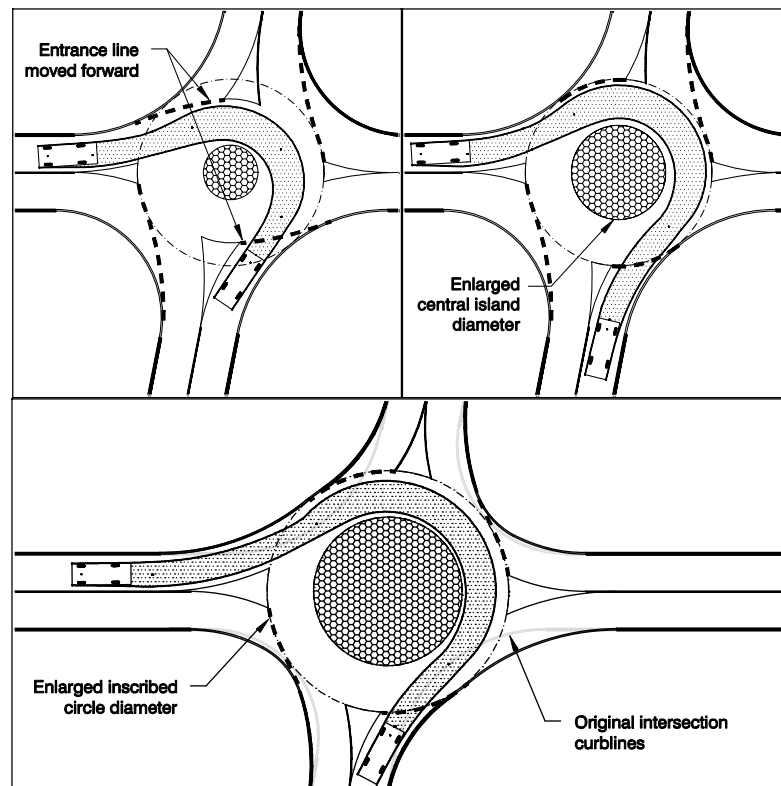

Exhibit 6-40
Possible Design Improve-
ments to Resolve Turning in
Front of Mini-Roundabout
Central Island



For intersections with excessive skew or offset approach alignments, the use of dual mini-roundabouts is another option for providing adequate vehicle channelization through the intersection (14–15, 17–18). Under this scenario, the intersection is divided into two adjacent mini-roundabouts. The design accommodates proper circulation for light vehicles (such as passenger cars) and traversable islands to allow for navigation of large vehicles through the intersection. Although this type of design has been implemented in the United Kingdom, it is rare elsewhere.

6.6.1.1 Splitter Islands

As with larger roundabouts, splitter islands are generally used at mini-roundabouts to align vehicles, encourage deflection and proper circulation, and provide pedestrian refuge. Splitter islands are raised, traversable, or flush depending on the size of the island and whether trucks will need to track over the top of the splitter island to navigate the intersection. In general, raised islands are used where possible, and flush islands are generally discouraged. The following are general guidelines for the types of splitter islands under various site conditions:

- Consider a raised island if:
 - All design vehicles can navigate the roundabout without tracking over the splitter island area,
 - Sufficient space is available to provide an island with a minimum area of 50 ft² (4.6 m²), and/or
 - Pedestrians are present at the intersection with regular frequency.
- Consider a traversable island if:
 - Some design vehicles must travel over the splitter island area and truck volumes are minor, and
 - Sufficient space is available to provide an island with a minimum area of 50 ft² (4.6 m²).
- Consider a flush (painted) island if:
 - Vehicles are expected to travel over the splitter island area with relative frequency to navigate the intersection,
 - An island with a minimum area of 50 ft² (4.6 m²) cannot be achieved, and
 - Intersection has slow vehicle speeds.

Where entrance lines are located within the inscribed circle, raised splitter islands typically terminate at the edge of the inscribed circle rather than being carried to the entrance line location. This allows sufficient space within the circulatory roadway for U-turn movements to occur. A painted or traversable splitter island should be continued to the entrance line to guide entering motorists around the central island.

In some cases, sufficient space may be available to provide a partial raised island within the pedestrian refuge area. An example of a raised island being terminated prior to the entrance line is illustrated in Exhibit 6-41. If raised islands are used, they should be visible to approaching motorists.

Exhibit 6-41
Raised Splitter Island
Terminated in Advance
of the Entrance Line



Dimondale, Michigan

6.6.1.2 Pedestrian Treatments at Mini-Roundabouts

At conventional intersections, pedestrian ramps and crosswalks are typically located near the curb returns at the corners of the intersection. When converting to a mini-roundabout, these corner pedestrian-crossing locations may require relocation. The crosswalk is recommended to be located 20 ft (6 m) upstream of the entrance line to accommodate one vehicle stopped between the crosswalk and the entrance line.

Where a traversable or raised splitter island is used, the walkway through the splitter island should be cut through instead of ramped. This is less cumbersome for wheelchair users and allows the cut-through walkway to be aligned with the crosswalks, providing guidance for all pedestrians but particularly for those who are blind or who have low vision. The cut-through walkway should be approximately the same width as the crosswalk, ideally a minimum width of 10 ft (3 m).

Sidewalk ramps must be provided to connect to the sidewalks at each end of the crosswalk. Wherever sidewalks are set back from the roundabout with a planting strip, ramps do not need to have flares and should simply have curbed edges aligned with the crosswalk to provide alignment cues for pedestrians who are blind or who have low vision. A detectable warning surface consisting of raised truncated domes is applied to the ramps to meet accessibility requirements.

Where a minimum splitter island width of 6 ft (1.8 m) is available on the approach, a pedestrian refuge should be provided within the splitter island. Where a pedestrian refuge is provided, the refuge area must be defined with the use of detectable warning surfaces. The detectable warning surface on splitter islands should begin at the curb line and extend into the cut-through area a distance of 2 ft (0.6 m), leaving a clear space of at least 2 ft (0.6 m) between detectable warning surfaces. Detailed standards for detectable warning surfaces can be found in the accessibility guidelines provided by the U.S. Access Board.

In some cases, the available roadway width may not be sufficient to provide an adequate refuge area, in which case pedestrians will need to cross in one stage. In such cases, no detectable warnings should be used within the splitter island.

6.6.1.3 Bicycles at Mini-Roundabouts

Since typical on-road bicycle travel speeds are between 12 and 20 mph (20 to 30 km/h), the speeds of vehicles approaching and traveling through mini-roundabouts are similar to those of bicyclists. Bicyclists are encouraged to navigate through a mini-roundabout like other vehicles. Where bicycle lanes are provided on the approaches to a mini-roundabout, they should be terminated to alert motorists and bicyclists of the need for bicyclists to merge. Bike lanes should be terminated at least 100 ft (30 m) upstream of the entrance line. Additional information on bicycle design considerations can be found in Section 6.8.2 and Chapter 7.

6.6.1.4 Vertical Design

Mini-roundabouts should be designed to be outward draining to place the central island at the highest point of the intersection for maximum visibility. This is consistent with most standard intersection grading, where the high point is located near the center of the intersection and sloping toward the outer curb lines. Therefore, in most retrofit situations, installation of a mini-roundabout would not necessarily require significant re-grading of the intersection.

6.6.2 DESIGN CONSIDERATIONS FOR MINI-ROUNDABOUTS AT THREE-LEG INTERSECTIONS

Typical T-intersections with perpendicular approach legs can present challenges to achieving deflection within the existing right-of-way. Exhibit 6-42 illustrates the simplest and least costly method for implementing a mini-roundabout at a standard T-intersection. The inscribed circle of the roundabout is located within the existing curb lines, which requires no additional right-of-way or modifications outside the existing intersection footprint. However, the downside of such a design is that little or no deflection is provided along the top of the T for a driver moving from right to left. Therefore, this type of design is best suited for locations where speeds are already low or where supplemental traffic calming devices can be provided upstream of the roundabout entry.

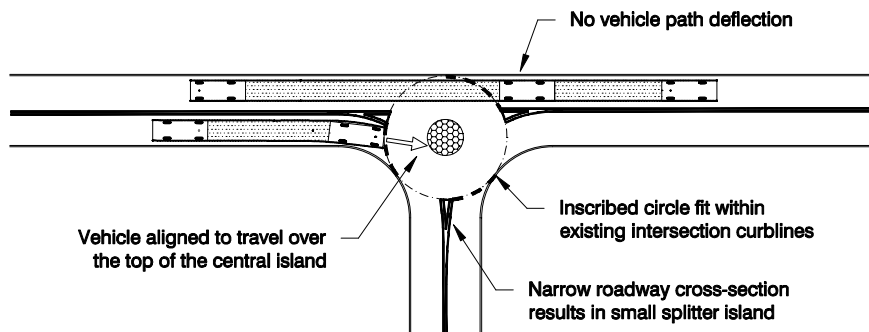

Exhibit 6-42
Mini-Roundabout within
Existing Intersection Footprint

Care must be taken in the splitter island design to provide adequate deflection for traffic traveling from left to right across the top of the T to be directed to circulate around the central island rather than simply traveling over top of it. Insufficient

deflection may lead to additional vehicle conflicts and premature wearing of the central island markings.

The preferred option for a mini-roundabout at a T-intersection is to deflect the outer curb line at the top of the T to provide deflection for all movements, as illustrated in Exhibit 6-43. This option may also allow for a slightly larger inscribed circle diameter, which will increase flexibility for larger vehicles to more easily navigate the intersection. Modifications to the curb lines will result in higher costs for this alternative and may also require additional right-of-way.

Exhibit 6-43
Mini-Roundabout with
Central Island Centered
Along Major Roadway

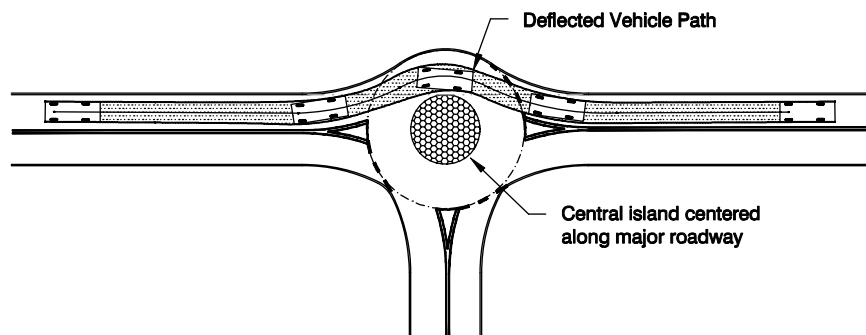

A third option achieves deflection for all movements by shifting the inscribed circle along the minor street axis, as illustrated in Exhibit 6-44. This option will likely require modification of all intersection curb lines and may require additional realignment of the approach legs upstream of the intersection. Care must be taken to sufficiently shift the central island to actually achieve deflection. Minor shifts of one or two feet are not likely to provide sufficient deflection because drivers will be able to simply pick a path that avoids the curb line bump-outs. Minor shifts may also be difficult to perceive by drivers and could result in vehicles running into the bump-outs.

Exhibit 6-44
Mini-Roundabout with
Inscribed Circle Shifted
Along Minor Street Axis

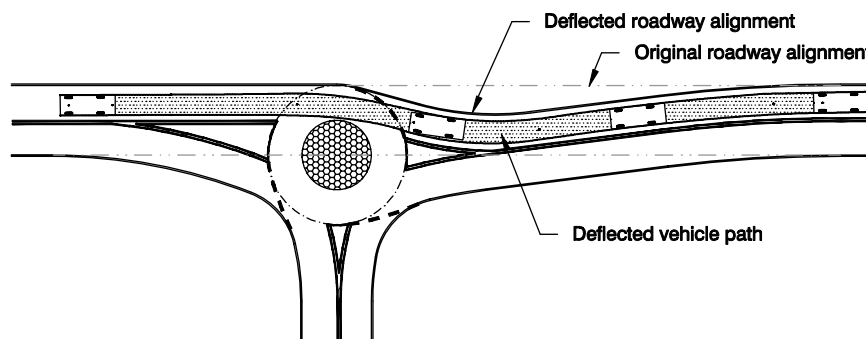

6.6.3 RIGHT-TURN BYPASS LANES

Right-turn bypass lanes can also be used at mini-roundabouts. Exhibit 6-45 shows an example. See Section 6.8.6 for further discussion.



Lutherville, Maryland

Exhibit 6-45
Mini-Roundabout with
Right Turn Bypass Lane

6.7 PERFORMANCE CHECKS

Performance checks are a vital part of roundabout design. These checks help an engineer determine whether the design meets its performance objectives.

6.7.1 FASTEST PATH

The fastest path allowed by the geometry determines the negotiation speed for that particular movement into, through, and exiting the roundabout. It is the smoothest, flattest path possible for a single vehicle, in the absence of other traffic and ignoring all lane markings. The fastest path is drawn for a vehicle traversing through the entry, around the central island, and out the relevant exit. The fastest paths must be drawn for all approaches and all movements, including left-turn movements (which generally represent the slowest of the fastest paths) and right-turn movements (which may be faster than the through movements at some roundabouts). Note that the fastest path methodology does not represent expected vehicle speeds, but rather theoretical attainable entry speeds for design purposes. Actual speeds can vary substantially based on vehicles suspension, individual driving abilities, and tolerance for gravitational forces.

Exhibit 6-46 illustrates the five critical path radii that must be checked for each approach. R_1 , the *entry path radius*, is the minimum radius on the fastest through path prior to the entrance line. R_2 , the *circulating path radius*, is the minimum radius on the fastest through path around the central island. R_3 , the *exit path radius*, is the minimum radius on the fastest through path into the exit. R_4 , the *left-turn path radius*, is the minimum radius on the path of the conflicting left-turn movement. R_5 , the *right-turn path radius*, is the minimum radius on the fastest path of a right-turning vehicle. It is important to note that these vehicular path radii are not the same as the curb radii. The R_1 through R_5 radii measured in this procedure represent the vehicle centerline in its path through the roundabout. Information on constructing the fastest paths is provided in Section 6.7.1.1

Exhibit 6-46
Vehicle Path Radii

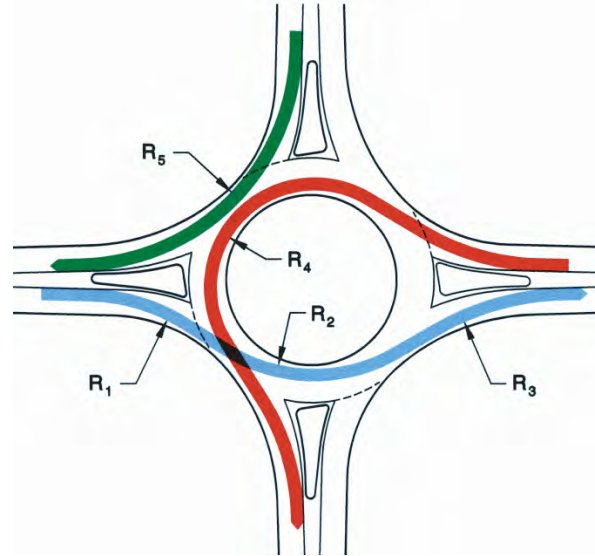

Recommended maximum theoretical entry design speeds for roundabouts at various intersection site categories are provided in Exhibit 6-47.

Exhibit 6-47
Recommended Maximum
Entry Design Speeds

Site Category	Recommended Maximum Theoretical Entry Design Speed
Mini-Roundabout	20 mph (30 km/h)
Single Lane	25 mph (40 km/h)
Multilane	25 to 30 mph (40 to 50 km/h)

Roundabout speed is determined by the fastest path allowed by the geometry.

Through movements are usually the fastest path, but sometimes right-turn paths are more critical.

Draw the fastest path for all roundabout approaches.

6.7.1.1 Construction of Vehicle Paths

To determine the speed of a roundabout, the fastest path allowed by the geometry is drawn. This is the smoothest, flattest path possible for a single vehicle, in the absence of other traffic and ignoring all lane markings, traversing through the entry, around the central island, and out the exit. The design speed of the roundabout is determined from the smallest radius along the fastest allowable path. The smallest radius usually occurs on the circulatory roadway as the vehicle curves to the left around the central island.

A vehicle is assumed to be 6 ft (2 m) wide and maintain a minimum clearance of 2 ft (0.5 m) from a roadway centerline or concrete curb and flush with a painted edge line (3). Thus the centerline of the vehicle path is drawn with the following distances to the particular geometric features:

- 5 ft (1.5 m) from a concrete curb,
- 5 ft (1.5 m) from a roadway centerline, and
- 3 ft (1.0 m) from a painted edge line.

Exhibit 6-48 and Exhibit 6-49 illustrate the construction of the fastest vehicle paths at a single-lane roundabout and at a multilane roundabout, respectively. Exhibit 6-50 provides an example of an approach at which the right-turn path is

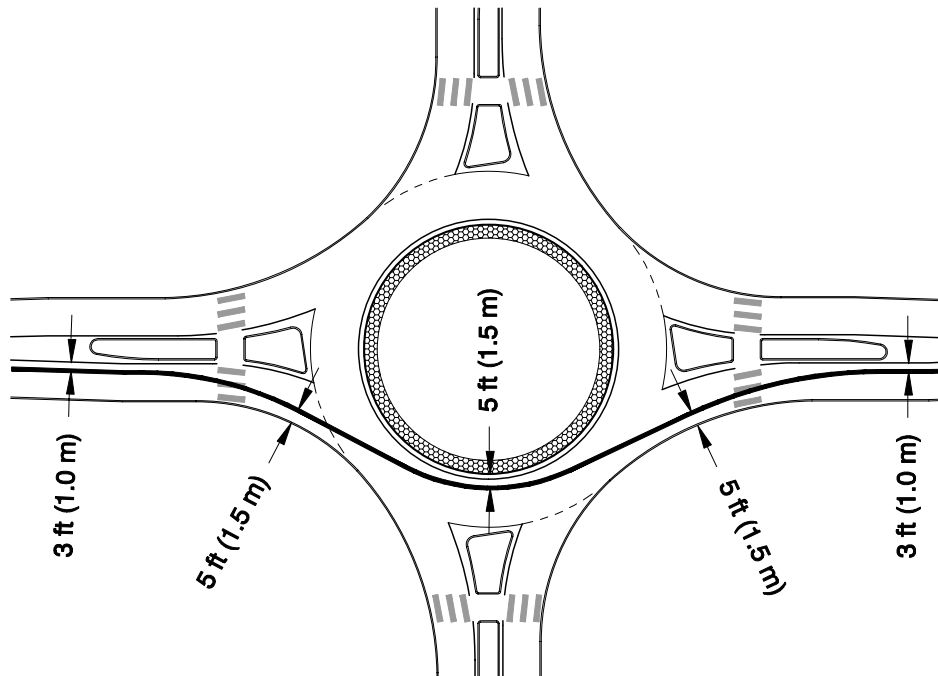

Exhibit 6-48
Fastest Vehicle Path through
Single-Lane Roundabout

more critical than the through movement. The fastest path should be drawn and checked for all approaches of the roundabout.

The fastest path for the through movement is a series of reverse curves (i.e., a curve to the right followed by a curve to the left followed by a curve to the right). When drawing the path, a short length of tangent should be drawn between consecutive curves to account for the time it takes for a driver to turn the steering wheel. Fastest paths may be drawn either freehand or with a computer aided drafting (CAD) program. The freehand technique can provide a natural representation of the way a driver negotiates the roundabout, with smooth transitions connecting curves and tangents. Having sketched the fastest path, the engineer can

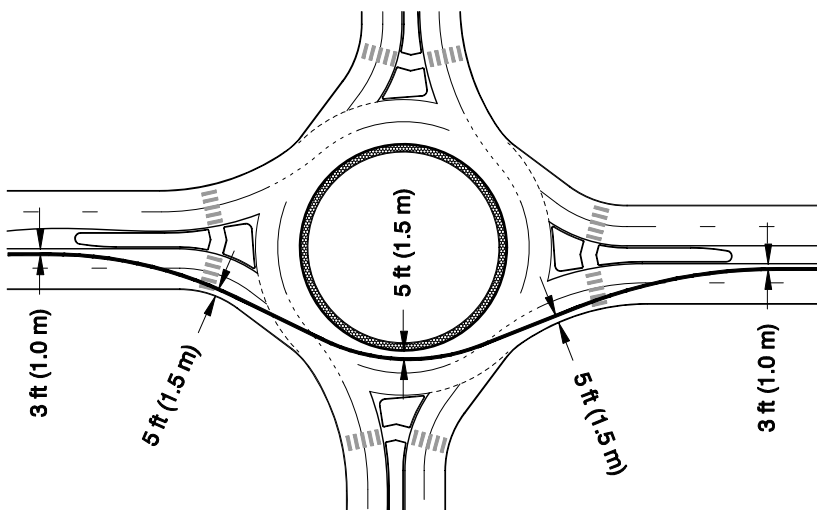
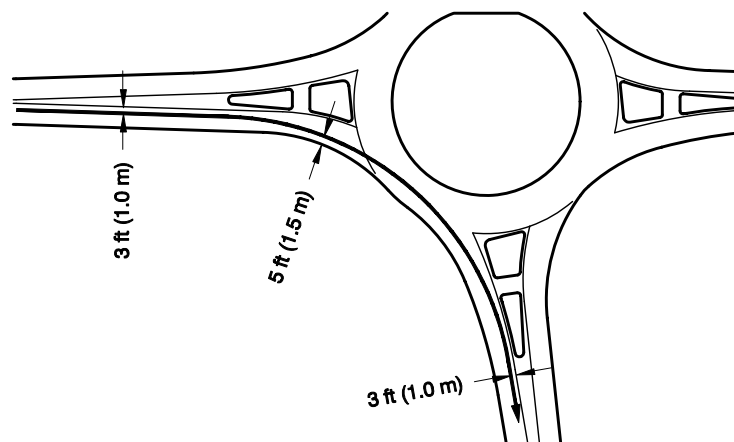

Exhibit 6-49
Fastest Vehicle Path through
Multilane Roundabout

Exhibit 6-50
Example of Critical
Right-Turn Movement



then measure the minimum radii using suitable curve templates or by replicating the path in CAD and using it to determine the radii. The Wisconsin Department of Transportation *Roundabout Guide* (7) provides one possible technique for creating fastest paths in CAD.

The entry path radius, R_1 , is a measure of the deflection imposed on a vehicle prior to entering the roundabout. The ability of the roundabout to control speed at the entry is a proxy for determining the potential safety of the roundabout and whether drivers are likely to yield to circulating vehicles (9). Additional guidance is provided in Exhibit 6-51 on drawing and measuring the R_1 radius. The construction of the fastest path should begin at least 165 ft (50 m) prior to the entrance line using the appropriate offsets identified above. The R_1 radius should be measured as the smallest best-fit circular curve over a distance of at least 65 to 80 ft (20 to 25 m) near the entrance line. This procedure is provided as guidance based upon design standards from the United Kingdom (9); however, other methods may provide equally acceptable results.

Exhibit 6-51
Guidance on Drawing and
Measuring the Entry
Path Radius

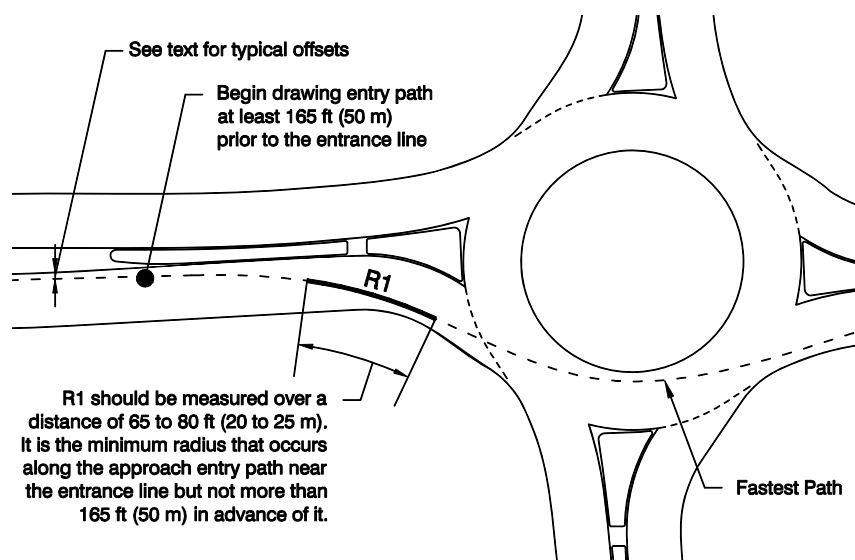

6.7.1.2 Vehicle Speed Estimation

The relationship between travel speed and horizontal curvature is documented in the AASHTO “Green Book” (4). Both superelevation and the side friction factor affect the speed of a vehicle. Side friction varies with vehicle speed and can be determined in accordance with AASHTO guidelines. The most common superelevation values encountered are +0.02 and –0.02, corresponding to 2% cross slope. Equation 6-1 and Equation 6-2 provide a simplified relationship between speed and radius for these two common superelevation rates that incorporates the AASHTO relationship and side friction factors. Exhibit 6-52 illustrates the speed–radius relationship in a graphical format. Additional information regarding the relationship of speed to superelevation and side friction is provided in Appendix D.

$$V = 3.4415R^{0.3861}, \text{ for } e = +0.02$$

Equation 6-1

$$V = 3.4614R^{0.3673}, \text{ for } e = -0.02$$

Equation 6-2

where

V = predicted speed, mph;
 R = radius of curve, ft; and
 e = superelevation, ft/ft.

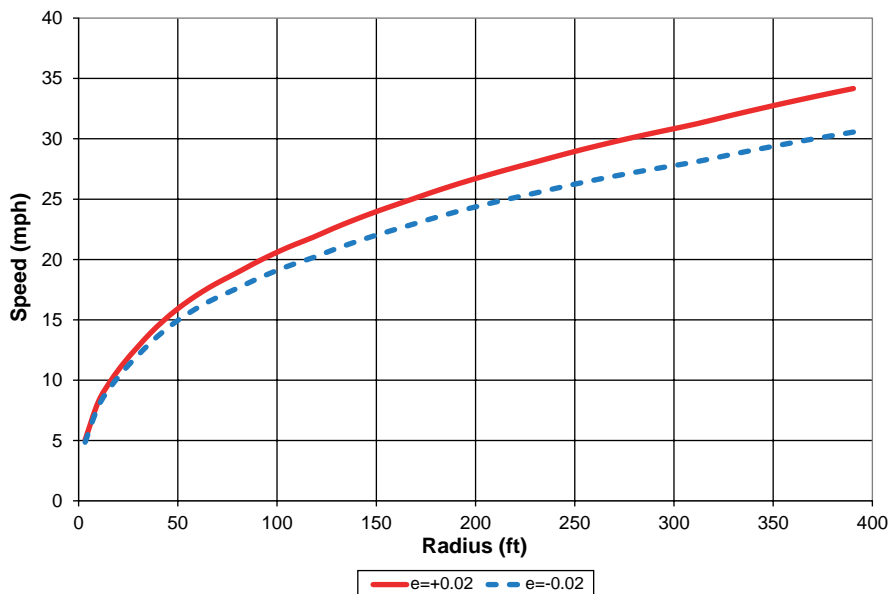

Exhibit 6-52
Speed–Radius Relationship

The speed–radius relationship given above generally provides a reasonable prediction for the left-turn and through movement circulating speeds. However, this method does not consider the effects of deceleration and acceleration and therefore may overpredict entry and exit speeds in cases where the path radius is large (1).

To better predict actual entry speeds, Equation 6-3 may be used to account for deceleration of vehicles from the entering (R_1) speed to the circulating (R_2)

speed. Analysts should use caution in using deceleration as a limiting factor to establish entry speeds for design. To promote safe design, deflection of the R_1 path radius should be the primary method for controlling entry speed. Therefore, while Equation 6-3 may provide an improved estimate of actual speed achieved at entry, for design purposes it is recommended that predicted speeds from Equation 6-1 be used.

Equation 6-3

$$V_1 = \min \left\{ \begin{array}{l} V_{1pbase} \\ \frac{1}{1.47} \sqrt{(1.47V_2)^2 + 2a_{12}d_{12}} \end{array} \right\}$$

where

V_1 = entry speed, mph;

V_{1pbase} = V_1 speed predicted based on path radius, mph;

V_2 = circulatory speed for through vehicles predicted based on path radius, mph;

a_{12} = deceleration between the point of interest along V_1 path and the midpoint of V_2 path = -4.2 ft/s^2 ; and

d_{12} = distance along the vehicle path between the point of interest along V_1 path and the midpoint of V_2 path, ft.

When identifying the predicted speed for the exit radius, R_3 , the acceleration effects of vehicles can have a more prominent effect on the outcome of the estimated speed. At locations with a large radius or tangential exit, the measured R_3 radius will be so large that the acceleration characteristics of the vehicle will govern the actual speeds that can be achieved. Therefore, tangential exits do not inherently result in excessive exit speeds as compared to exits with some curvature, provided that circulating speeds are low and the distance to the point of interest on the exit (typically the crosswalk) is short. While it is desirable to provide some degree of curvature on the exit to reduce the visual appearance of a straight shot, recent U.S. research indicates that such curvature does not appear to always be the controlling factor for exit speeds (1). Exit speed can be estimated using Equation 6-4.

Equation 6-4

$$V_3 = \min \left\{ \begin{array}{l} V_{3pbase} \\ \frac{1}{1.47} \sqrt{(1.47V_2)^2 + 2a_{23}d_{23}} \end{array} \right\}$$

where

V_3 = exit speed, mph;

V_{3pbase} = V_3 speed predicted based on path radius, mph;

V_2 = circulatory speed for through vehicles predicted based on path radius, mph;

a_{23} = acceleration between the midpoint of V_2 path and the point of interest along V_3 path = 6.9 ft/s^2 ; and

d_{23} = distance along the vehicle path between midpoint of V_2 path and point of interest along V_3 path, ft.

With all predicted speeds, the engineer is cautioned to look at the entire trajectory of the subject movement to determine what speeds are reasonable for each part of the trajectory. The above discussion highlights observed limitations on entry and exit speed based on circulating speed. However, other relationships may exist for a given design. For example, an approach curve prior to the entry (with radius R_0) may govern the speed that can be reached at the entry. A combination of low entry speed and low exit speed may make the theoretical speed of the intervening circulating movement less relevant. More generally, the speed environment leading into the roundabout may govern speeds. An entry coming from a parking lot may have a considerably lower observed entry speed than an entry coming from a high-speed rural roadway, even with the same entry geometry.

Look at the entire trajectory of the subject movement to determine what speeds are reasonable for each part of the trajectory

6.7.1.3 Speed Consistency

Consistency between the speeds of various movements within the intersection can help to minimize the crash rate between conflicting traffic streams. Relative speeds between conflicting traffic streams and between consecutive geometric elements should be minimized such that the maximum speed differential between movements should be no more than approximately 10 to 15 mph (15 to 25 km/h). These values are typically achieved by providing a low absolute maximum speed for the fastest entering movements. As with other design elements, speed consistency should be balanced with other objectives in establishing a design.

6.7.1.4 Improving Fastest Path Vehicle Speeds

Iteration within the design process is an integral part of roundabout design. Often, it takes several iterations to achieve the balanced design objectives that are desired. Size, location, and alignment are commonly at the heart of achieving adequate vehicle speeds. If the sketching of the fastest paths identifies speeds that are above the recommended thresholds, the engineer is encouraged to look at the big picture of the design to evaluate these key variables rather than focusing in on the details. Often, in an attempt to achieve adequate vehicle speeds, engineers will produce overly small entry radii or too narrow entry width, which can impact safety, capacity, and the ability to accommodate heavy vehicles.

At single-lane roundabouts, it is relatively simple to reduce the value of R_1 . Possible options include shifting the alignment of the approach further to the left to achieve a slower entry speed (with the potential trade-off of higher exit speeds that may put pedestrians at risk), increasing the size of the inscribed circle diameter, and in some cases making adjustments to the initial entry width/radii parameters that were selected. At multilane roundabouts it is generally more difficult to produce a balanced design to meet all of the principles. As an example, overly small entry curves may allow the design to meet the fastest path speed recommendations; however, this may also cause the natural path of adjacent traffic streams to overlap.

6.7.2 PATH ALIGNMENT (NATURAL PATH) CONSIDERATIONS

As discussed previously, the fastest path through the roundabout is drawn to ensure that the geometry imposes sufficient curvature to achieve a safe design speed. This path is drawn assuming the roundabout is vacant of all other traffic

and the vehicle cuts across adjacent travel lanes, ignoring all lane markings. In addition to evaluating the fastest path, at multilane roundabouts the engineer should also consider the natural vehicle paths. These are the paths approaching vehicles will naturally take through the roundabout geometry, assuming there is traffic in all approach lanes.

The key consideration in drawing the natural path is to remember that drivers cannot change the direction or speed of their vehicle instantaneously. This means that the natural path does not have sudden changes in curvature; it has transitions between tangents and curves and between consecutive reversing curves. Secondly, it means that consecutive curves should be of similar radius. If a second curve has a significantly smaller radius than the first curve, the driver will be traveling too fast to negotiate the turn and may not be able stay within the lane. If the radius of one curve is drawn significantly smaller than the radius of the previous curve, the path should be adjusted.

To identify the natural path of a given design, it is better to sketch the natural paths over the geometric layout, rather than use a computer drafting program or manual drafting equipment. In sketching the path, the engineer will naturally draw transitions between consecutive curves and tangents, similar to the way a driver would negotiate an automobile. Freehand sketching also enables the engineer to feel how changes in one curve affect the radius and orientation of the next curve. The sketch technique, Exhibit 6-53, allows the engineer to quickly obtain a smooth, natural path through the geometry that may be more difficult to obtain using a computer. Additional discussion of design techniques to avoid path overlap is provided in Section 6.5.4. As a rule of thumb, the design should provide at least one car length of large radius or tangent to adequately align vehicles into the correct lane within the circulatory roadway.

Exhibit 6-53
Natural Vehicle Path Sketched
through Roundabout

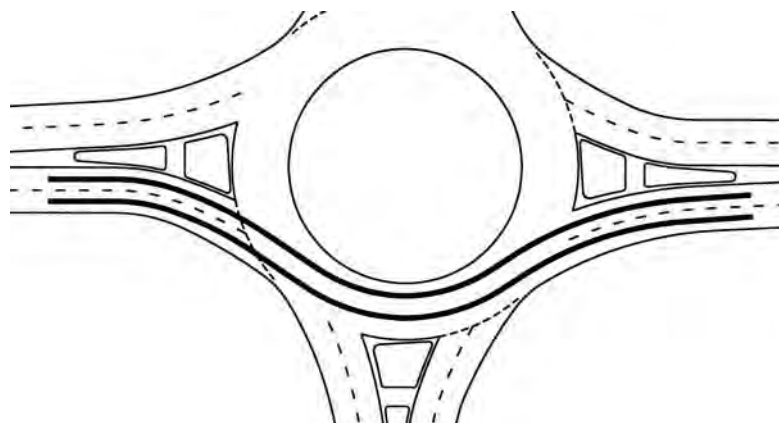

6.7.3 SIGHT DISTANCE

The two most relevant aspects of sight distance for roundabouts are stopping sight distance and intersection sight distance.

6.7.3.1 Stopping Sight Distance

Stopping sight distance is the distance along a roadway required for a driver to perceive and react to an object in the roadway and to brake to a complete stop before reaching that object. Stopping sight distance should be provided at every point within a roundabout and on each entering and exiting approach.

NCHRP Report 400: Determination of Stopping Sight Distances (19) recommends the formula given in Equation 6-5 for determining stopping sight distance.

$$d = (1.468)(t)(V) + 1.087 \frac{V^2}{a}$$

Equation 6-5

where

- d = stopping sight distance, ft;
- t = perception–brake reaction time, assumed to be 2.5 s;
- V = initial speed, mph; and
- a = driver deceleration, assumed to be 11.2 ft/s².

Exhibit 6-54 gives stopping sight distances computed from the above equations.

Speed (km/h)	Computed Distance* (m)	Speed (mph)	Computed Distance* (ft)
10	8.1	10	46.4
20	18.5	15	77.0
30	31.2	20	112.4
40	46.2	25	152.7
50	63.4	30	197.8
60	83.0	35	247.8
70	104.9	40	302.7
80	129.0	45	362.5
90	155.5	50	427.2
100	184.2	55	496.7

* Assumes 2.5 s perception–braking time, 3.4 m/s² (11.2 ft/s²) driver deceleration

Exhibit 6-54
Computed Values for
Stopping Sight Distance

Stopping sight distance should be measured using an assumed height of driver's eye of 3.5 ft (1,080 mm) and an assumed height of object of 2 ft (600 mm), in accordance with the AASHTO "Green Book" (4).

At roundabouts, a minimum of three critical types of locations should be checked:

1. Approach sight distance (Exhibit 6-55),
2. Sight distance on circulatory roadway (Exhibit 6-56), and
3. Sight distance to crosswalk on exit (Exhibit 6-57).

Forward sight distance at entry can also be checked; however, this will typically be satisfied by providing adequate stopping sight distance on the circulatory roadway itself.

At least three critical types of locations should be checked for stopping sight distance.

Roundabouts: An Informational Guide

Exhibit 6-55
Stopping Sight Distance
on the Approach

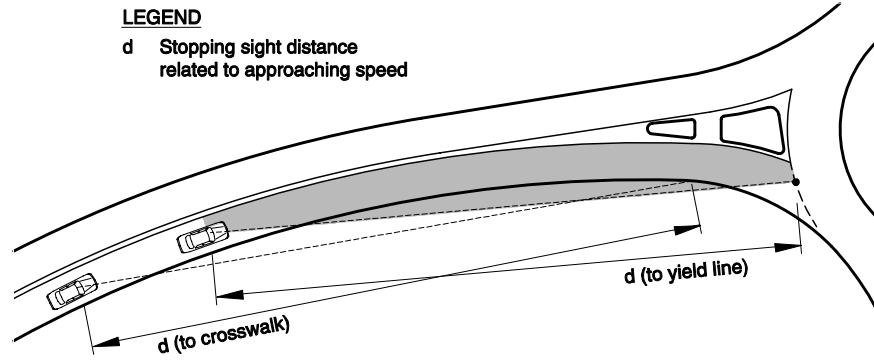

Exhibit 6-56
Stopping Sight Distance
on Circulatory Roadway

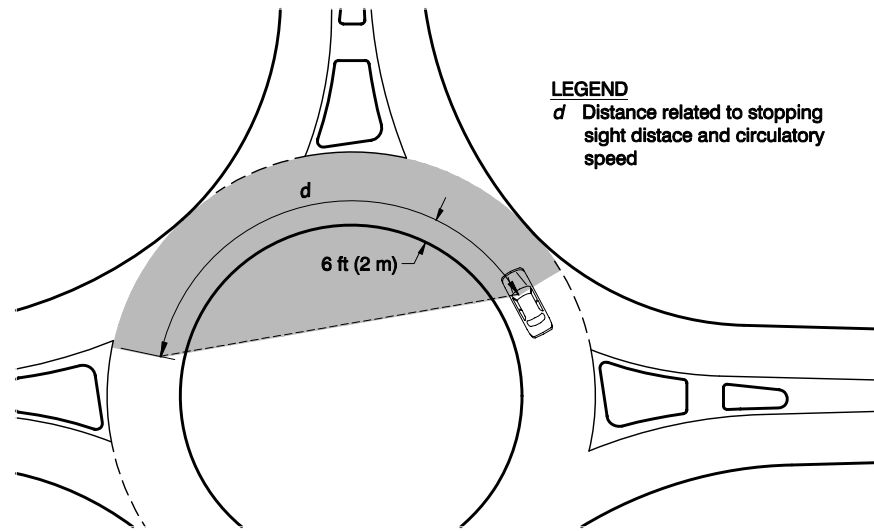
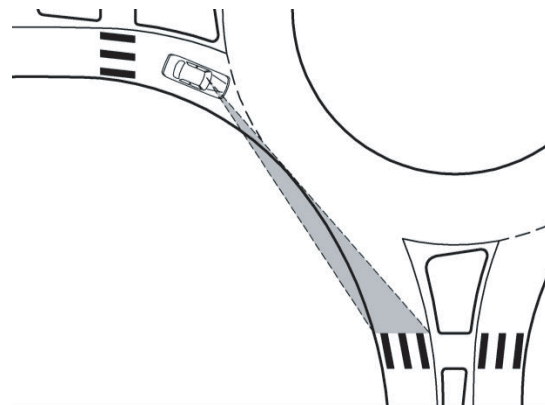

Exhibit 6-57
Sight Distance to
Crosswalk on Exit



6.7.3.2 Intersection Sight Distance

Intersection sight distance is the distance required for a driver without the right-of-way to perceive and react to the presence of conflicting vehicles. Intersection sight distance is achieved through the establishment of *sight triangles* that allow a driver to see and safely react to potentially conflicting vehicles. At roundabouts, the only locations requiring evaluation of intersection sight distance are the entries.

Intersection sight distance is traditionally measured through the determination of a sight triangle. This triangle is bounded by a length of roadway defining a limit away from the intersection on each of the two conflicting approaches and by a line connecting those two limits. For roundabouts, these legs should be assumed to follow the curvature of the roadway, and thus distances should be measured not as straight lines but as distances along the vehicular path.

Intersection sight distance should be measured using an assumed height of driver's eye of 3.5 ft (1,080 mm) and an assumed height of object of 3.5 ft (1,080 mm) in accordance with the AASHTO "Green Book" (4) which is based upon *NCHRP Report 383: Intersection Sight Distances* (20).

Exhibit 6-58 presents a diagram showing the method for determining intersection sight distance. As can be seen in the exhibit, the sight distance triangle has two conflicting approaches that must be checked independently. The following two subsections discuss the calculation of the length of each of the approaching sight limits.

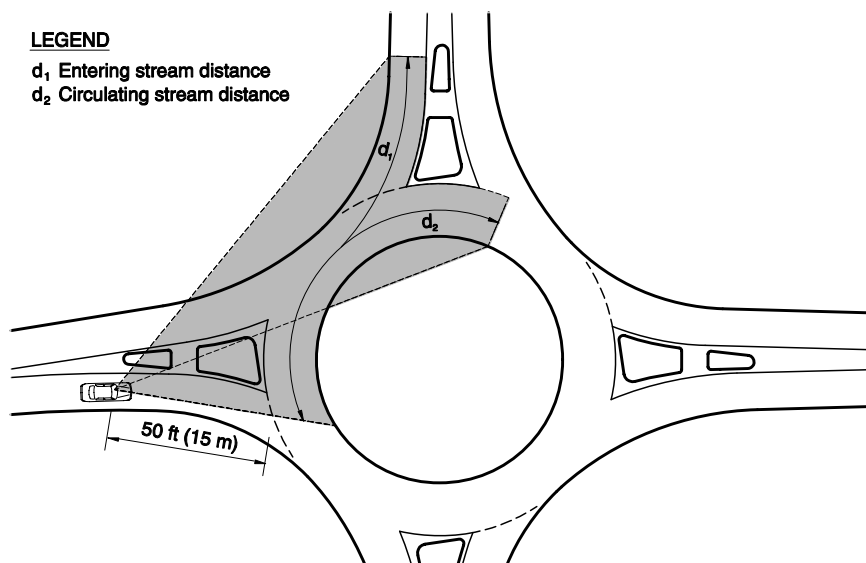

Entries to roundabouts require adequate intersection sight distance.

Exhibit 6-58
Intersection Sight Distance

6.7.3.3 Length of Approach Leg of Sight Triangle

The length of the approach leg of the sight triangle should be limited to 50 ft (15 m). British research on sight distance has determined that excessive intersection sight distance results in a higher frequency of crashes. This value, consistent with British and French practice, is intended to require vehicles to slow down prior to entering the roundabout, which supports the need to slow down and yield at the roundabout entry and allows drivers to focus on the pedestrian crossing prior to

entry. If the approach leg of the sight triangle is greater than 50 ft (15 m), it may be advisable to add landscaping to restrict sight distance to the minimum requirements.

6.7.3.4 Length of Conflicting Leg of Sight Triangle

A vehicle approaching an entry to a roundabout faces conflicting vehicles within the circulatory roadway and on the immediate upstream entry. The length of the conflicting leg is calculated using Equation 6-6 and Equation 6-7:

Equation 6-6

$$d_1 = (1.468)(V_{major, entering})(t_c)$$

Equation 6-7

$$d_2 = (1.468)(V_{major, circulating})(t_c)$$

where

- d_1 = length of entering leg of sight triangle, ft;
- d_2 = length of circulating leg of sight triangle, ft;
- V_{major} = design speed of conflicting movement, mph, discussed below; and
- t_c = critical headway for entering the major road, s, equal to 5.0 s.

Two conflicting traffic streams should be checked at each entry:

1. *Entering stream*, which is composed of vehicles from the immediate upstream entry. The speed for this movement can be approximated by taking the average of the theoretical entering (R_1) speed and the circulating (R_2) speed.
2. *Circulating stream*, which is composed of vehicles that enter the roundabout prior to the immediate upstream entry. This speed can be approximated by taking the speed of left-turning vehicles (path with radius R_4).

The critical headway for entering the major road is based on the amount of time required for a vehicle to safely enter the conflicting stream. The critical headway value of 5.0 s given in Equation 6-6 and Equation 6-7 is based upon the critical headway required for passenger cars (2). This critical headway value represents an interim methodology pending further research. Some individual states or municipalities have elected to use alternative critical headway values ranging from 4.5 to 6.5 seconds. Exhibit 6-59 shows computed length of the conflicting leg of an intersection sight triangle.

Exhibit 6-59
Computed Length of
Conflicting Leg of
Intersection Sight Triangle

Conflicting Approach Speed (mph)	Computed Distance (ft)	Conflicting Approach Speed	
		(km/h)	Computed Distance (m)
10	73.4	20	27.8
15	110.1	25	34.8
20	146.8	30	41.7
25	183.5	35	48.7
30	220.2	40	55.6

Note: Computed distances are based on a critical headway of 5.0 s.

Providing more than the minimum required intersection sight distance can lead to higher speeds that reduce intersection safety.

In most cases it is best to provide no more than the minimum required intersection sight distance on each approach. Excessive intersection sight distance can lead to higher vehicle speeds that reduce the safety of the intersection for all road users (motorists, bicyclists, pedestrians). Landscaping can be effective in restricting sight distance to the minimum requirements.

6.7.3.5 Combined Sight Distance Diagram

During design and review, roundabouts should be checked to ensure that adequate stopping and intersection sight distance is being provided. Checks for each approach should be overlaid onto a single drawing, as shown in Exhibit 6-60, to illustrate the clear vision areas for the intersection. This provides guidance on the appropriate locations for various types of landscaping or other treatments. Landscaping can be effective in restricting sight distance to the minimum needed and provides an important mechanism for alerting drivers to the presence and location of the roundabout.

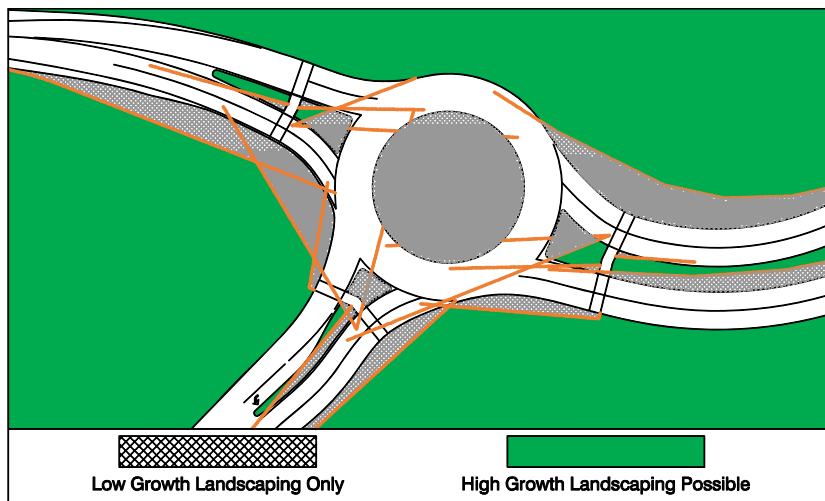

Exhibit 6-60
Example Sight
Distance Diagram

The hatched portions in Exhibit 6-60 are areas that should be clear of large obstructions that may hinder driver visibility. Objects such as low growth vegetation, poles, sign posts, and narrow trees may be acceptable within some of these areas provided that they do not create a hazard for errant vehicles or significantly obstruct the visibility of other vehicles, pedestrians, the splitter islands, the central island, or other key roundabout components. In the remaining areas (with solid shading), especially within the central island, taller landscaping may be used to break the forward view for through vehicles, thereby contributing to speed reductions and reducing oncoming headlight glare. Note that other factors like speed environment may further control landscaping design; refer to Chapter 9 for more discussion.

6.7.4 ANGLES OF VISIBILITY

The intersection angle between consecutive entries must not be overly acute in order to allow drivers to comfortably turn their heads to the left to view oncoming traffic from the immediate upstream entry. The intersection angle between consecutive entries, and indeed the angle of visibility to the left for all entries, should conform to the same design guidelines as for conventional intersections. Guidance for designing for older drivers and pedestrians recommends using 75° as a minimum intersection angle (21).

Roundabouts: An Informational Guide

At roundabouts, the intersection angle may be measured as the angle between a vehicle’s alignment at the entrance line and the sight line required according to intersection sight-distance guidelines. Exhibit 6-61 shows an example design with a severe angle of visibility to the left, and Exhibit 6-62 shows a possible correction. Note that in any complex roundabout like this one, corrections for one effect may introduce other challenges, such as the closer proximity of the entrance in the lower left corner of the exhibit to the entrance in the lower right corner. The engineer needs to balance trade-offs when determining the best course of action.

Exhibit 6-61
Example Design with Severe
Angle of Visibility to Left

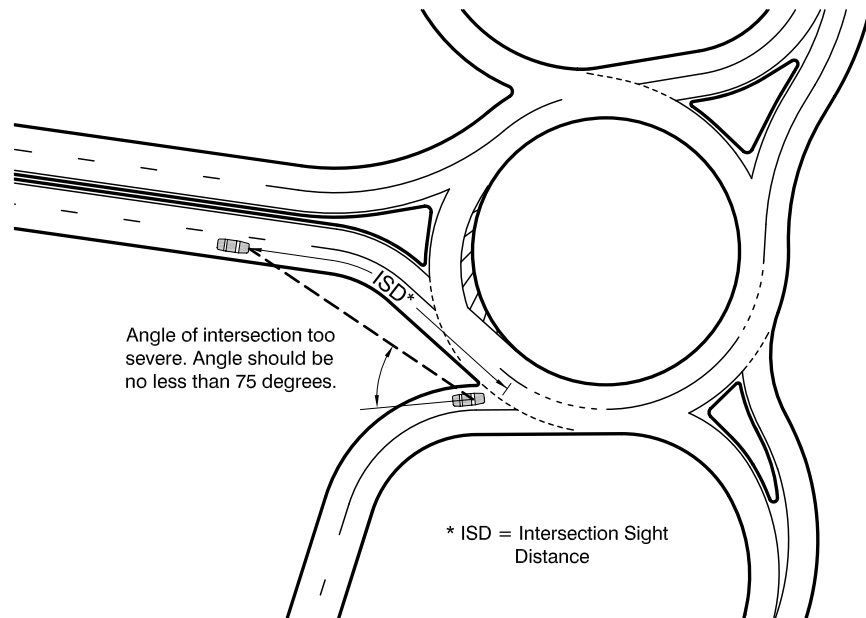

Source: California Department of Transportation (1)

Exhibit 6-62
Roundabout with Realigned
Ramp Terminal Approach
to Provide Better Angle
of Visibility to Left

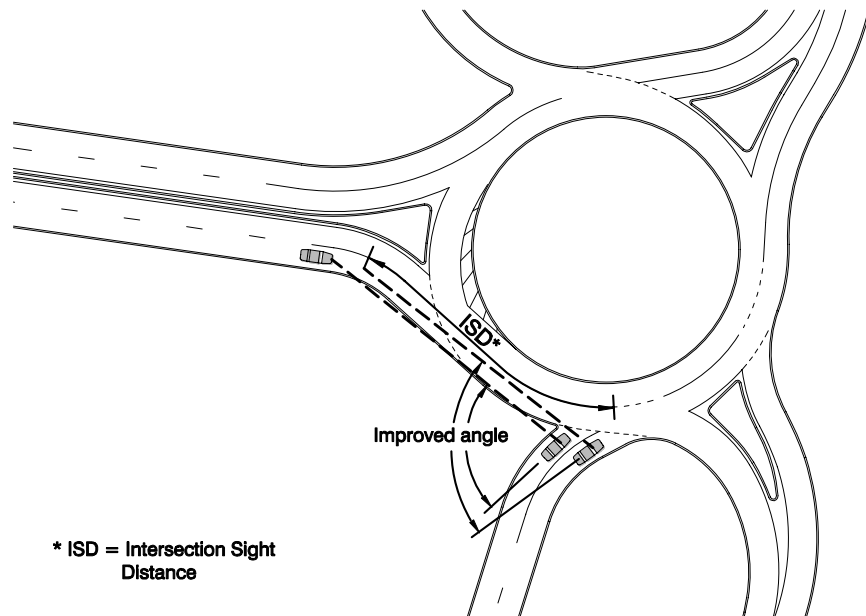

Source: California Department of Transportation (1)

6.8 DESIGN DETAILS

This section provides a discussion of a variety of design details that are common to all types of roundabouts.

6.8.1 PEDESTRIAN DESIGN CONSIDERATIONS

6.8.1.1 Sidewalks

Whenever possible, sidewalks at roundabouts should be set back from the edge of the circulatory roadway with a landscape strip. Landscape strips provide many benefits, including increased comfort for pedestrians, room for street furniture and snow storage, and a buffer to allow for the overhang of large vehicles as they navigate the roundabout. Two additional important benefits are that the setback discourages pedestrians from crossing to the central island or cutting across the circulatory roadway of the roundabout and that the setback helps guide pedestrians with vision impairments to the designated crosswalks.

The draft Public Rights-of-Way Accessibility Guidelines (PROWAG) (22) include a requirement to provide a detectable edge treatment between sidewalks and roundabouts wherever pedestrian crossings are not intended. A recommended setback distance of 5 ft (1.5 m) should be used [minimum of 2 ft (0.6 m)], and it is best to plant low shrubs or grass in the area between the sidewalk and curb (see Chapter 7). Where there is not enough room to provide adequate setback, fencing or other barriers may be necessary to guide pedestrians with vision impairments to the crosswalks. Fencing may also be advantageous in areas where high numbers of pedestrians make pedestrian entry into the circulatory roadway likely (e.g., on a college campus). Exhibit 6-63 and Exhibit 6-64 provide examples of sidewalk treatments.

Set back sidewalks 1.5 m (5 ft) from the circulatory roadway where possible.

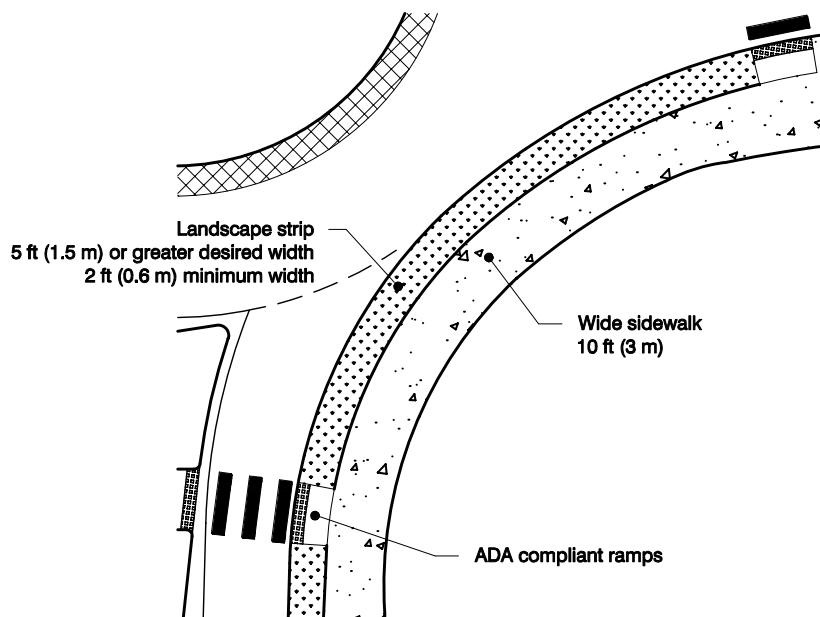
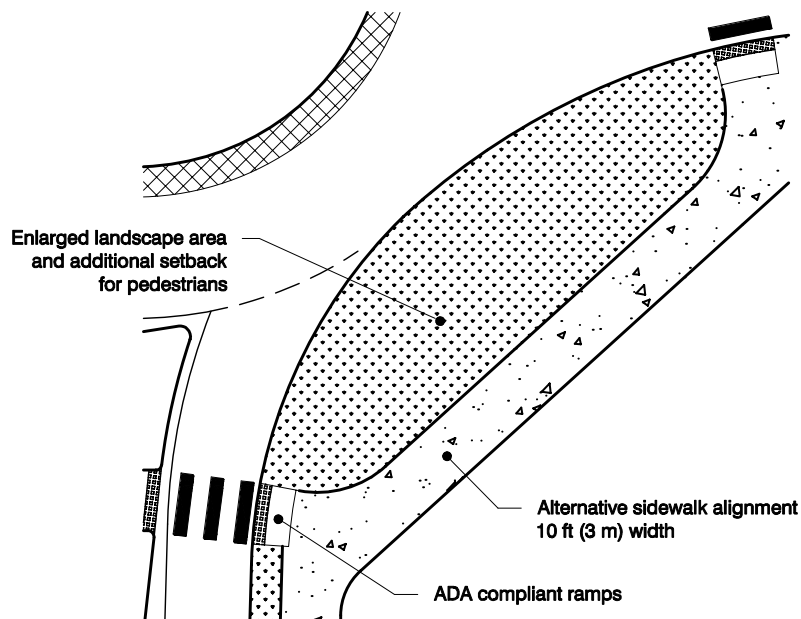

Exhibit 6-63
Sidewalk Treatment Example

Roundabouts: An Informational Guide

Exhibit 6-64
Alternative Sidewalk
Treatments



The recommended sidewalk width at roundabouts is 6 ft (1.8 m), and the minimum width is 5 ft (1.5 m). In areas with heavy pedestrian volumes, sidewalks should be as wide as necessary to accommodate the anticipated pedestrian volume. At any roundabout where ramps provide sidewalk access to bicyclists, the sidewalk should be a minimum of 10 ft (3 m) wide to accommodate shared use by pedestrians and bicyclists. An example of sidewalk setback is given in Exhibit 6-65.

Exhibit 6-65
Example Sidewalk Setback
at Roundabouts

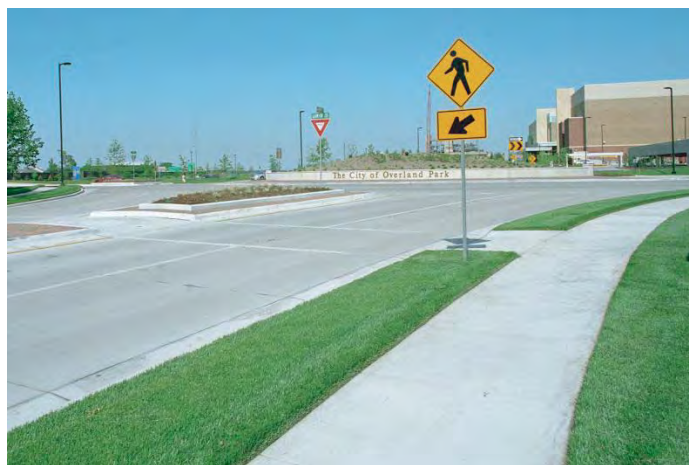

Overland Park, Kansas

6.8.1.2 Crosswalks

Pedestrian crosswalk placement at roundabouts requires consistency, based on a balance between pedestrian convenience, pedestrian safety, and roundabout operations:

- *Pedestrian convenience:* Pedestrians desire crossing locations as close to the roundabout as possible to minimize out-of-direction travel. The further

the crossing is from the roundabout, the more likely pedestrians will choose a shorter route that may put them in greater danger. On the other hand, placing crosswalks at distances away from the entrance line that are approximately in increments of vehicle lengths reduces the chance that queued vehicles will be stopped on the crosswalk, blocking convenient crossing movements by pedestrians.

- *Pedestrian safety:* Both crossing distance and crossing location are important. Crossing distance should be minimized to reduce exposure of pedestrians to vehicular conflicts. Due to the flared entry at most roundabouts, crosswalk placement somewhat back from the entrance line will result in shorter crossing distance. Placing crosswalks back also helps drivers first focus their attention on the pedestrian crosswalk before moving forward and focusing their attention to the left to look for gaps in the circulating traffic stream.
- *Roundabout operations:* Vehicular roundabout operations can also be affected by crosswalk locations, particularly on the exit. A queuing analysis at the exit crosswalk may determine that a crosswalk location of more than one vehicle length may be desirable to reduce the likelihood of queuing into the circulatory roadway. Pedestrians may more easily be able to visually distinguish exiting vehicles from circulating vehicles at crosswalks located further from the roundabout.

With these ideas in mind, pedestrian crosswalks should be designed as follows:

- The raised splitter island width should be a minimum of 6 ft (1.8 m) at the crosswalk to adequately provide shelter for persons pushing a stroller or walking a bicycle (see Section 6.2.5).
- Pedestrian crossings should ideally be located in vehicle-length increments away from the edge of the circulatory roadway, or the yield line if one is provided. A typical and minimum crosswalk setback of 20 ft (6 m) is recommended. This is the length of one vehicle without any additional distance to account for the gap between vehicles, since ideally the crosswalk is placed within this gap. At some roundabouts, it may be desirable to place the crosswalk two or three car lengths [45 ft (13.5 m) or 70 ft (21.5 m)] back from the edge of the circulatory roadway; note that these dimensions include a 5 ft (1.5 m) gap between queued vehicles. The approach and exit geometry at roundabouts often makes it impractical to keep the crosswalk setback at a consistent distance from the edge of the circulatory roadway.
- There are two options for the alignment of a pedestrian crosswalk at roundabouts:
 - Place each leg of the crosswalk approximately perpendicular to the outside curb of the circulatory roadway for both the entry lane(s) and the exit lane(s). This creates an angle point in the walkway across the splitter island (see Exhibit 6-66). The advantages of this design are that it creates the shortest possible total crossing distance and makes it easier to build accessible ramps to the sidewalk, since the crossing is perpendicular to the curb.

Roundabouts: An Informational Guide

Exhibit 6-66
Crosswalk Alignment Options

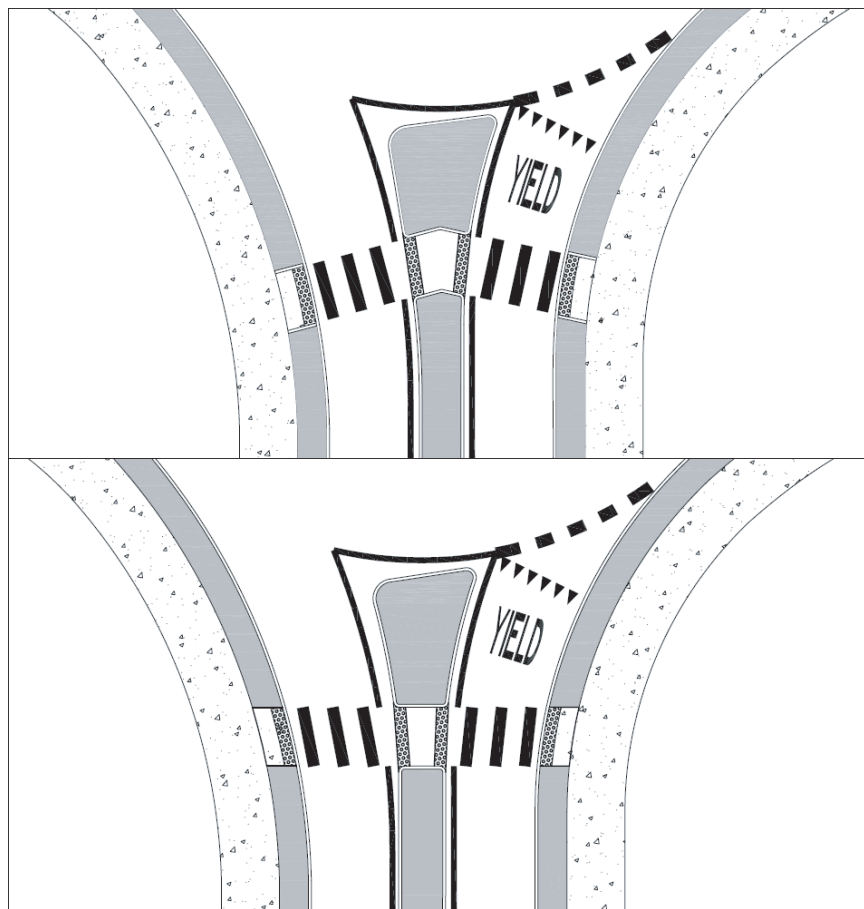

- Place the entire crosswalk perpendicular to the centerline of the approach roadway. This results in angled crossings of the entry and exit lanes. The advantages of this design are a shorter overall walking distance for pedestrians and less variability in the distance between the edge of the circulatory roadway and the crosswalk. However, this can result in fairly long and overly skewed crosswalks at roundabouts where the entry lane(s) and/or exit lane(s) are angled significantly at the crosswalk location. In addition, since the curb ramp still needs to be perpendicular to the curb for mobility-impaired users, the curb ramp may not be aligned parallel with the crosswalk in order to provide alignment cues to visually impaired pedestrians.
- The walkway through the splitter island should be cut through instead of ramped. This is less cumbersome for wheelchair users and allows the cut-through walkway to be aligned with the crosswalks, providing guidance for all pedestrians, but particularly for those who are blind or who have low vision. The cut-through walkway should be approximately the same width as the crosswalk, ideally a minimum width of 10 ft (3.0 m).
- Sidewalk ramps must be provided to connect to the sidewalks at each end of the crosswalk. Wherever sidewalks are set back from the roundabout

with a planting strip as recommended above, ramps do not need to have flares and should simply have curbed edges aligned with the crosswalk. This provides alignment cues for pedestrians, especially those who are blind or who have low vision. Additional guidelines related to accessible curb ramp design can be found in the PROWAG as well as other documents published by the Access Board.

- Detectable warning surfaces consisting of raised truncated domes, as required by accessibility guidelines, should be applied to the ramps and also along the full width of the cut-through walkway within the splitter island. The detectable warning surface on splitter islands should begin at the curb line and extend into the cut-through area a distance of 2 ft (0.6 m). This results in a minimum 2 ft (0.6 m) clear space between detectable warning surfaces on a splitter island with the minimum recommended width of 6 ft (1.8 m) at the pedestrian crossing. Detailed standards for detectable warning surfaces can be found in the PROWAG published by the Access Board.
- Crosswalk markings should be installed on all roundabout approaches where sidewalks and ramps lead to pedestrian crossings. Additional information on crosswalk markings can be found in Chapter 7.

Raised crosswalks (speed tables with pedestrian crossings on top) are another design treatment that can encourage slow vehicle speeds where pedestrians cross. As described elsewhere in this document, good geometric design is important at all roundabouts to encourage slow vehicle speeds. Raised crosswalks may be beneficial to reduce vehicles speeds at any location where vehicle speeds are higher than desirable at crosswalk locations. Raised crosswalks also make crossings very easy for pedestrians with mobility impairments, who will not need to go up and down ramps as much as they would otherwise. Raised crosswalks need to have detectable warnings as described above to clearly delineate the edge of the street.

6.8.2 BICYCLE DESIGN CONSIDERATIONS

Safety and usability of roundabouts for bicyclists depends on the details of the roundabout design and special provisions for bicyclists. At roundabouts, some cyclists may choose to travel like other vehicles, while others may choose to travel like pedestrians. Roundabouts can be designed to simplify this choice for cyclists.

Since typical on-road bicycle travel speeds are between 12 and 20 mph (19 to 32 km/h), roundabouts that are designed to constrain the speeds of motor vehicles to similar values will minimize the relative speeds between bicyclists and motorists, and thereby improve safety and usability for cyclists. As described in Section 6.2, roundabouts designed for urban conditions should have a recommended maximum entry speed of 20 to 30 mph (32 to 48 km/h); these roundabouts are generally compatible with bicycle travel.

Single-lane roundabouts are much simpler for cyclists than multilane roundabouts since they do not require cyclists to change lanes to make left-turn movements or otherwise select the appropriate lane for their direction of travel. In addition, at single-lane roundabouts, motorists are less likely to cut off cyclists when exiting the roundabout. Therefore, it is important not to select a multilane roundabout over a single-lane roundabout in the short term, even when long-term

traffic predictions suggest that a multilane roundabout may be desirable. In addition, the use of a roundabout with two-lane entries for the major roadway and one-lane entries for the minor roadway can be a good solution to minimize complexity for bicyclists where a roundabout is proposed at an intersection of a major multilane street and a minor street.

6.8.2.1 Designing for Bicyclists to Traverse Roundabouts like Vehicles

In general, cyclists who have the knowledge and skills to ride effectively and safely on collector roadways can navigate low-speed, single-lane roundabouts without much difficulty. Cyclists and motorists will travel at approximately the same speed, making it easier for bicyclists to merge with other vehicular traffic and take the lane within the roundabout itself; these are necessary actions for safe bicycling in a roundabout. Even at multilane roundabouts, many cyclists will be comfortable traveling through like other vehicles.

Where bicycle lanes or shoulders are used on approach roadways, they should be terminated in advance of roundabouts. The full-width bicycle lane should normally end at least 100 ft (30 m) before the edge of the circulatory roadway. Terminating the bike lane helps remind cyclists that they need to merge. An appropriate taper should be provided to narrow the sum of the travel lane and bike lane widths down to the appropriate width necessary to achieve desired motor vehicle speeds on the roundabout approach. The taper should end prior to the crosswalk at the roundabout to achieve the shortest possible pedestrian crossing distance. A taper rate of 7:1 is recommended to accommodate a design speed of 20 mph (30 km/h), which is appropriate for bicyclists and motor vehicles approaching the roundabout. To taper a 5 ft to 6 ft (1.4 m to 1.8 m) wide bicycle lane, a 40 ft (12.2 m) taper is recommended. The bicycle lane line should be dotted for 50 to 200 ft (15 m to 60 m) prior to the beginning of the taper and dropped entirely through the taper itself. A longer dotted line gives advance notice to cyclists that they need to merge, providing more room for them to achieve this maneuver and find an appropriate gap in traffic.

Bicycle lanes should not be located within the circulatory roadway of roundabouts. This would suggest that bicyclists should ride at the outer edge of the circulatory roadway, which can increase crashes resulting from exiting motorists who cut off circulating bicyclists and from entering motorists who fail to yield to circulating bicyclists.

At roundabout exits, an appropriate taper should begin after the crosswalk, with a dotted line for the bike lane through the taper. The solid bike lane line should resume as soon as the normal bicycle lane width is available.

6.8.2.2 Designing for Bicyclists to Traverse Roundabouts like Pedestrians

Because some cyclists may not feel comfortable traversing some roundabouts in the same manner as other vehicles, bicycle ramps can be provided to allow access to the sidewalk or a shared use path at the roundabout. Bicycle ramps at roundabouts have the potential to be confused as pedestrian ramps, particularly for pedestrians who are blind or who have low vision. Therefore, bicycle ramps should only be used where the roundabout complexity or design speed may result in less comfort for some bicyclists. Ramps should not normally be used at urban, one-lane round-

Bicycle lanes should not be placed around the outside of the circulatory roadway of roundabouts.

Ramps to provide sidewalk access for bicyclists can be confusing for pedestrians who are blind or have low vision, so bicycle ramps should only be used at roundabouts where some cyclists may have difficulty circulating like other vehicles.

abouts. As described in Section 6.8.2, multilane roundabouts are more challenging for cyclists, and bike ramps can be used to provide the option to travel through the roundabout like a pedestrian. Bike ramps may also be appropriate at single-lane roundabouts if traffic speeds or other conditions (e.g., a right turn bypass lane) make circulating like other vehicles more challenging for bicyclists.

Where bicycle ramps are provided at a roundabout, consideration should be given to providing a shared-use path or a widened sidewalk at the roundabout. In areas with relatively low pedestrian use and where bicycle use of the sidewalks is expected to be low, the normal sidewalk width may be sufficient; however, in most situations, a minimum 10 ft (3 m) sidewalk width is recommended. If the sidewalk is designated as a shared-use path, appropriate shared-use path design details should be applied. The reader is encouraged to refer to the *AASHTO Guide for Development of Bicycle Facilities* (23) for a more detailed discussion of the design requirements for shared-use paths.

In some jurisdictions, state or local laws may prohibit cyclists from riding on sidewalks. In these areas, the following options could be considered:

- Bicycle ramps can simply not be used.
- Ramps could be installed using one of the following options:
 - Signs could be posted to remind cyclists that they need to walk their bicycles on the sidewalk.
 - An exception could be made to allow cyclists to ride on the sidewalks at the roundabout; appropriate regulatory signs would need to be posted.
 - The sidewalk could be designed and designated as a shared use path.

The design details of bicycle ramps are critical to provide choice to cyclists, ensure usability by cyclists, and reduce the potential for confusion of pedestrians, particularly those who are blind or who have low vision. Bicycle ramps should be placed at the end of the full-width bicycle lane where the taper for the bicycle lane begins. Cyclists approaching the taper and bike ramp will thus be provided the choice of merging left into the travel lane or moving right onto the sidewalk. Bike ramps should not be placed directly in line with the bike lane or otherwise placed in a manner that appears to cyclists that the bike ramp and the sidewalk is the recommended path of travel through the roundabout. This encourages more sidewalk use by bicyclists, which can have a negative effect on pedestrians at the roundabout and may be less safe for bicyclists as well. Bicycle ramps should be placed at least 50 ft (15 m) prior to the crosswalk.

Whenever possible, bicycle ramps should be placed entirely within the planting strip between the sidewalk and the roadway. In these locations, the bicycle ramps should be placed at a 35° to 45° angle to the roadway and the sidewalk to enable cyclists to use the ramp even if pulling a trailer, but to discourage them from entering the sidewalk at high speed. The bike ramp can be fairly steep, with a slope potentially as high as 20%. If placed within the sidewalk area itself, the ramp slope must be built in a manner so that it is not a tripping hazard. Exhibit 6-67 and Exhibit 6-68 illustrate several possible designs of bike ramps, depending on whether a planting strip is available and the available sidewalk width.

Roundabouts: An Informational Guide

Exhibit 6-67
Possible Treatments
for Bicycles

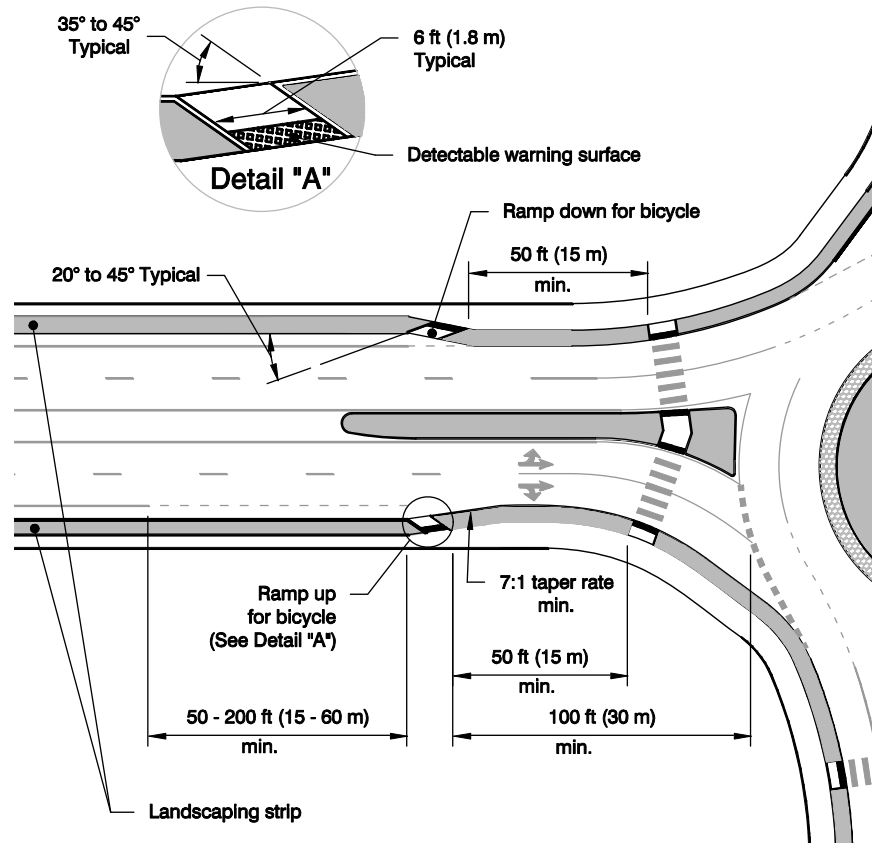
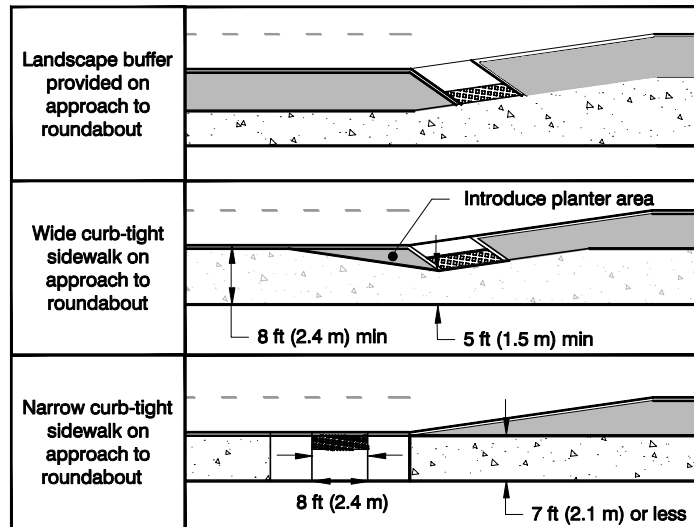

Exhibit 6-68
Bicycle Ramp
Design Options



Since bike ramps can be confusing for pedestrians with vision impairments, detectable warnings should be included on the ramp. Where the ramp is placed in a planter strip, the detectable warning field should be placed at the top of the ramp since the ramp itself is part of the vehicular area for which the detectable warning is used. If the ramp is in the sidewalk itself, the detectable warning should be placed at the bottom of the ramp. Other aspects of the bike ramp design and placement can

help keep pedestrians from misconstruing the bike ramp as a pedestrian crossing location. These aspects include the angle of the ramp, the possible steeper slope of the ramp, and location of the ramp relatively far from the roundabout and crosswalk.

Bicycle ramps at roundabout exits should be built with similar geometry and placement as the ramps at roundabout entries. On exits, the angle between the bike ramp and the roadway can be as small as 20° since it is not necessary to encourage bicyclists to slow down as they reenter the roadway, but some angle is necessary so that blind pedestrians do not inadvertently travel down the ramp. Bike ramps should be placed at least 50 ft (15 m) after the crosswalk at the roundabout exit.

6.8.3 PARKING CONSIDERATIONS

Parking in the circulatory roadway is not conducive to efficient and safe roundabout operations and should typically be prohibited. Parking on entries and exits should also be set back far enough so as not to hinder roundabout operations or to impair the visibility of pedestrians. AASHTO recommends that parking should end at least 20 ft (6.1 m) from the crosswalk of an intersection (4). Curb extensions or bulb-outs are recommended to clearly mark the limit of permitted parking and reduce the width of the entries and exits.

6.8.4 BUS STOP LOCATIONS

For safety and operational reasons, bus stops should be located sufficiently far away from entries and exits and never in the circulatory roadway. Nearside and far-side bus stops should be located and designed as follows:

- *Nearside stops:* If a bus stop is to be provided on the near side of a roundabout, it should typically be located far enough away from the splitter island so that a vehicle overtaking a stationary bus is in no danger of being forced into the splitter island, especially if the bus starts to pull away from the stop. If an approach has only one lane and capacity is not an issue on that entry, the bus stop could be located at the pedestrian crossing in the lane of traffic. This is not recommended for entries with more than one lane because vehicles in the lane next to the bus may not see pedestrians. At multilane roundabouts, a nearside bus stop can be included in the travel lane (a bus bulb-out design), as long as it is set back at least 50 ft (15 m) from the crosswalk. Nearside stops provide the advantage of having a potentially slower speed environment where vehicles are slowing down, compared to a far-side location where vehicles may be accelerating upon exiting the roundabout.
- *Far-side stops:* Bus stops on the far side of a roundabout should be located beyond the pedestrian crossing to improve visibility of pedestrians to other exiting vehicles. Far-side stops result in the crosswalk being behind the bus, which provides for better sight lines for vehicles exiting the roundabout to pedestrians and keeps bus patrons from blocking the progress of the bus when they cross the street. The use of bus pullouts has some trade-offs to consider. A positive feature of a bus pullout is that it reduces the likelihood of queuing behind the bus into the roundabout. A possible negative feature is that a bus pullout may create sight line challenges for the bus driver to see vehicles approaching from behind when

attempting to merge into traffic. It may also be possible at multilane roundabouts in slow-speed urban environments to include a bus stop without a bus pullout immediately after the crosswalk, as exiting traffic has an opportunity to pass the waiting bus.

In a traffic-calmed environment, or close to a school, it may be appropriate to locate the bus stop at a position that prevents other vehicles from passing the bus while it is stopped.

6.8.5 TREATMENTS FOR HIGH-SPEED APPROACHES

Roundabouts located on rural roads often have special design considerations because approach speeds are higher than for urban or local streets, and drivers do not expect to encounter speed interruptions. The primary safety concern in rural locations is to make drivers aware of the roundabout with ample distance to comfortably decelerate to the appropriate speed. The design of a roundabout in a high-speed environment typically employs all of the techniques of roundabouts in a lower-speed environment, with greater emphasis on the items presented in the remainder of this section.

6.8.5.1 Visibility

An important feature affecting safety at rural intersections is the visibility of the intersection itself. Roundabouts are no different from stop-controlled or signalized intersections in this respect except for the presence of curbing along roadways that are typically not curbed. The potential for single-vehicle crashes can be minimized with attention to proper visibility of the roundabout and its approaches. Where possible, the geometric alignment of approach roadways should be constructed to maximize the visibility of the central island and the shape of the roundabout. Where adequate visibility cannot be provided solely through geometric alignment, additional treatments (signing, pavement markings, advanced warning beacons, etc.) should be considered (see Chapter 7). Note that many of these treatments are similar to those that would be applied to rural stop-controlled or signalized intersections.

6.8.5.2 Curbing

On an open rural highway, changes in the roadway's cross section can be an effective means to help approaching drivers recognize the need to reduce their speed. Rural highways typically have no outside curbs with wide paved or gravel shoulders. Narrow shoulder widths and curbs on the outside edges of pavement, on the other hand, generally give drivers a sense they are entering a more controlled setting, causing them to naturally slow down. Thus, when installing a roundabout on an open rural highway, curbs should be provided at the roundabout and on the approaches, and consideration should be given to reducing shoulder widths.

Curbs help to improve delineation and to prevent corner cutting, which helps to ensure low speeds. In this way, curbs help to confine vehicles to the intended design path. The engineer should carefully consider all likely design vehicles, including farm equipment, when setting curb locations. Little research has been performed to date regarding the length of curbing required in advance of a rural roundabout. However, some Australian guidance suggests that curbing should be

Roundabout visibility is a key design element at rural locations.

Curbs should be provided at all rural roundabouts.

provided in advance of the splitter island. It may be desirable to extend the curbing from the approach for at least the length of the required deceleration distance to the roundabout.

6.8.5.3 Splitter Islands

Another effective cross-section treatment to reduce approach speeds is to use longer splitter islands on the approaches (24). Splitter islands should generally be extended upstream of the entrance line to the point at which entering drivers are expected to begin decelerating comfortably. A minimum length of 200 ft (60 m) is recommended for high-speed approaches (24). Exhibit 6-69 provides a diagram of such a splitter island design. The length of the splitter island may differ depending upon the approach speed. The use of flatter and longer tapers in advance of the splitter islands also provides additional visual cues to drivers of a change in roadway environment. The design of the roundabout entry can also provide visual cues to drivers, in that the entry curves from the splitter island block the view of the central island as drivers approach the roundabout.

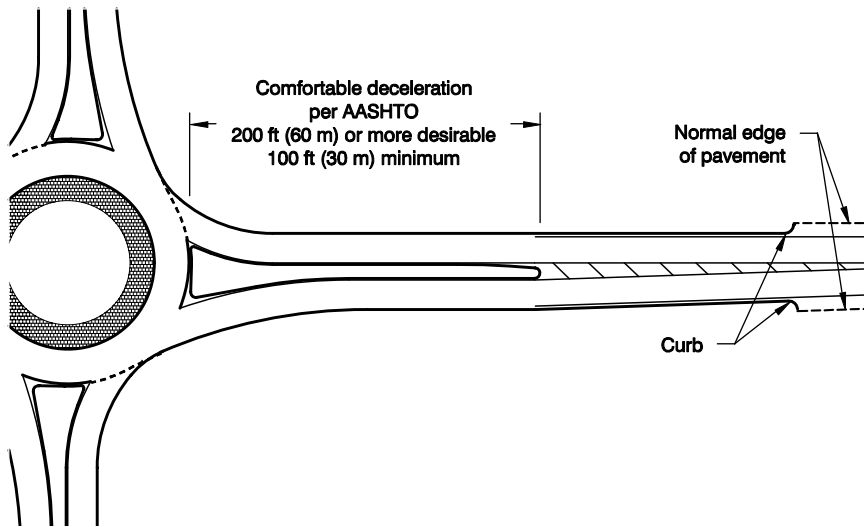

6.8.5.4 Approach Curves

Roundabouts on high-speed roads [speeds of 50 mph (80 km/h) or higher], despite extra signing efforts, may not be expected by approaching drivers, resulting in erratic behavior and an increase in single-vehicle crashes. Good design encourages drivers to slow down before reaching the roundabout, and this can be most effectively achieved through a combination of geometric design and other design treatments (see Chapter 7). Where approach speeds are high, speed consistency on the approach needs to be addressed to avoid forcing all of the reduction in speed to be completed through the curvature at the roundabout.

The radius of an approach curve (and subsequent vehicular speeds) has a direct impact on the frequency of crashes at a roundabout. A study in Queensland, Australia, has shown that decreasing the radius of an approach curve generally decreases the approaching rear-end vehicle crash rate and the entering–circulating

Extended splitter islands are recommended at rural locations.

Exhibit 6-69
Extended Splitter
Island Treatment

A series of progressively sharper curves on a high-speed roundabout approach helps slow traffic to an appropriate entry speed.

and exiting–circulating vehicle crash rates (see Chapter 5). On the other hand, decreasing the radius of an approach curve may increase the single-vehicle crash rate on the curve, particularly when the required side-friction for the vehicle to maintain its path is too high. This may encourage drivers to cut across lanes and increase sideswipe crashes on the approach (3).

One method to achieve speed reduction that reduces crashes at the roundabout while minimizing single-vehicle crashes is the use of successive curves on approaches. The Queensland study found that by limiting the change in 85th-percentile speed on successive geometric elements to approximately 12 mph (20 km/h), the crash rate was reduced. It was found that the use of successive reverse curves prior to the roundabout approach curve reduced the single-vehicle crash rate and the sideswipe crash rate on the approach. It is recommended that approach speeds immediately prior to the entry curves of the roundabout be limited to approximately 35 mph (60 km/h) to minimize high-speed rear-end and entering–circulating vehicle crashes.

Exhibit 6-70 shows a typical rural roundabout design with a succession of three curves prior to the entrance line. As shown in the exhibit, these approach curves should be successively smaller radii in order to minimize the reduction in design speed between successive curves. The aforementioned Queensland study found that shifting the approaching roadway laterally by approximately 23 ft (7 m) usually enables adequate curvature to be obtained while keeping the curve lengths to a minimum. If the lateral shift is too small, drivers are more likely to cut into the adjacent lane (3).

Exhibit 6-70
Use of Successive Curves
on High-Speed Approaches

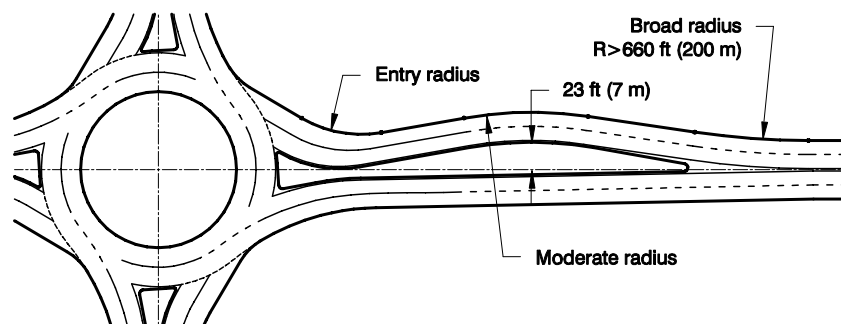

Right-turn bypass lanes can be used in locations with minimal pedestrian and bicycle activity to improve capacity when heavy right-turning traffic exists.

6.8.6 RIGHT-TURN BYPASS LANES

At locations with a high volume of right-turning traffic, a right-turn bypass lane may allow a single-lane roundabout to continue to function acceptably and avoid the need to upgrade to a multilane roundabout. Extending the life of the single-lane roundabout is desirable given the stronger safety performance in comparison to multilane roundabouts due to the smaller size and slower speeds that are achieved.

A right-turn bypass lane (or right-turn slip lane) should be implemented only where needed, especially in urban areas with bicycle and pedestrian activity. The entries and exits of bypass lanes can increase conflicts with bicyclists and with merging on the downstream leg. The generally higher speeds of bypass lanes and

the lower expectation of drivers to stop may increase the risk of collisions with pedestrians. They also introduce additional complexity for pedestrians with visual impairments who are attempting to navigate the intersection. However, in locations with minimal pedestrian and bicycle activity, or where bicycle and pedestrian concerns can be addressed through design, right-turn bypass lanes can be used to improve capacity when heavy right-turning traffic exists.

The provision of a right-turn bypass lane allows right-turning traffic to bypass the roundabout, providing additional capacity for the through and left-turn movements at the approach. Bypass lanes are most beneficial when the demand of an approach exceeds its capacity and a significant proportion of the traffic is turning right. However, it is important to consider the reversal of traffic patterns during the opposite peak time period. In some cases, the use of a right-turn bypass lane can avoid the need to build an additional entry or circulatory lane. To determine if a right-turn bypass lane should be used, the capacity and delay calculations in Chapter 4 should be performed. Right-turn bypass lanes can also be used in locations where the geometry for right turns is too tight to allow trucks to turn within the roundabout. Exhibit 6-71 shows examples of right-turn bypass lanes.



(a) Avon, Colorado



(b) Keene, New Hampshire

Exhibit 6-71
Examples of Right-turn
Bypass Lane

Roundabouts: An Informational Guide

Right-turn bypass lanes can merge back into the main exit roadway or provide a yield-controlled entrance onto the main exit roadway.

There are two design options for right-turn bypass lanes. The first option, shown in Exhibit 6-72 (full bypass), is to carry the bypass lane parallel to the adjacent exit roadway, and then merge it into the main exit lane. Under this option, the bypass lane should be carried alongside the main roadway for a sufficient distance to allow vehicles in the bypass lane and vehicles exiting the roundabout to accelerate to comparable speeds. The bypass lane is then merged at a taper rate according to AASHTO guidelines for the appropriate design speed. The second design option (partial bypass) for a right-turn bypass lane, shown in Exhibit 6-73, is to provide a yield-controlled entrance onto the adjacent exit roadway. The first option provides better

Exhibit 6-72
Configuration of Right-turn Bypass Lane with Acceleration Lane

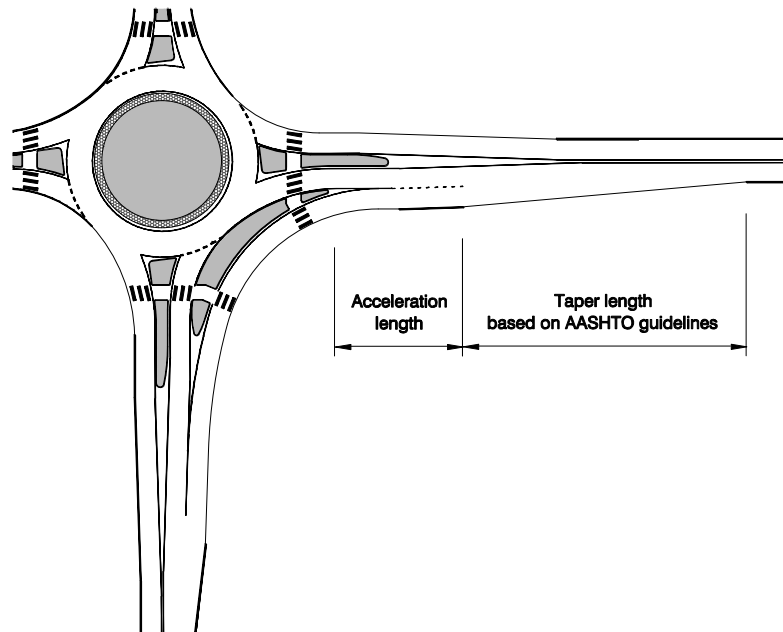
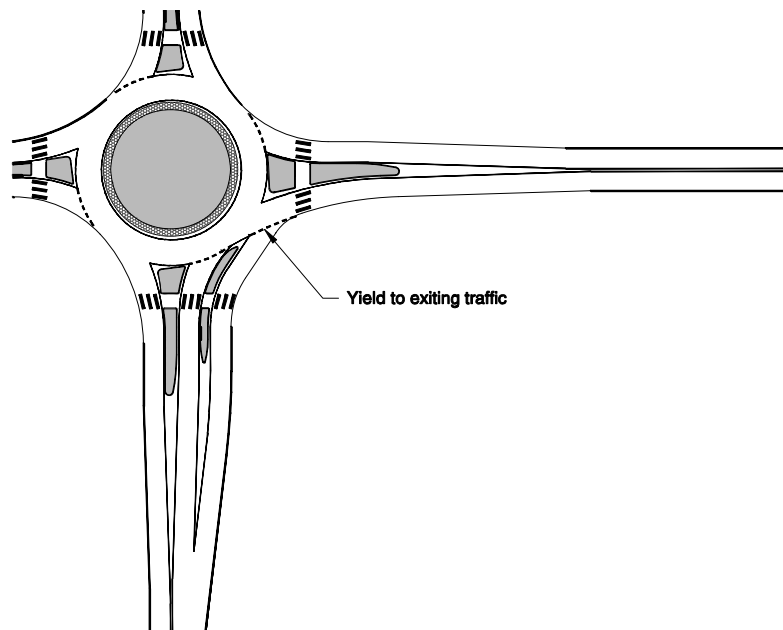

Exhibit 6-73
Configuration of Right-turn Bypass Lane with Yield at Exit Leg



operational performance than the second. However, the second option generally requires less construction and right-of-way than the first.

The option of providing yield control on a bypass lane is generally better for bicyclists and pedestrians and is recommended as the preferred option in urban areas where pedestrians and bicyclists are prevalent. Acceleration lanes can be problematic for bicyclists because they can be caught between two merging streams of motor vehicles. In addition, yield control at the end of a bypass lane tends to slow motorists down, whereas an acceleration lane at the end of a bypass lane tends to promote higher speeds. For both types of bypass lanes, it may sometimes be possible to develop the right-turn-only lane well in advance of the intersection and place a through bicycle lane to the left of the right-turn-only lane, similar to the standard design for conventional intersections. This would make the presence of a right-turn bypass lane less challenging for bicyclists.

The radius of the right-turn bypass lane should not be significantly larger than the radius of the fastest entry path provided at the roundabout. This will ensure that vehicle speeds on the bypass lane are similar to speeds through the roundabout, resulting in safe merging of the two roadways. A small radius also offers greater safety for pedestrians who must cross the right-turn slip lane.

Instead of providing a full bypass lane, another option is to provide a partial bypass by introducing a small vane island (gore striping), as illustrated in Exhibit 6-74. The vane island may be painted or raised, depending upon the dimensions of the islands. Note that additional care must be provided in the design of an entry with two adjacent lanes. Additional design details are provided in Section 6.5.

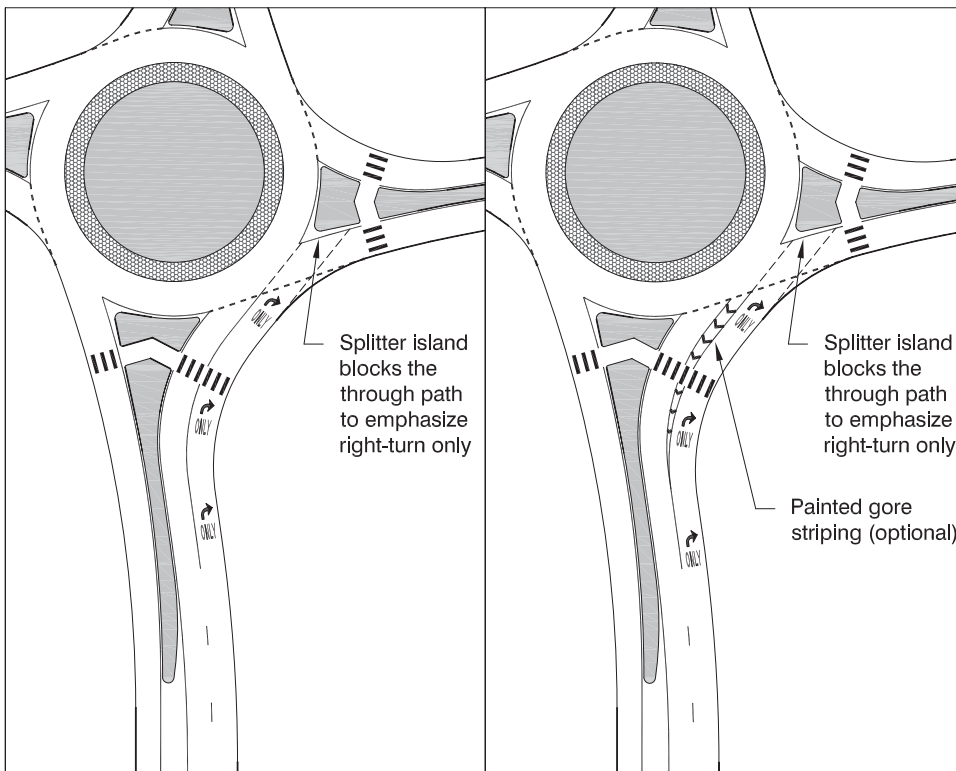

Exhibit 6-74
Exclusive Right-Turn
Lane Designs

6.8.7 VERTICAL CONSIDERATIONS

Components of vertical alignment design for roundabouts include profiles, superelevation, approach grades, and drainage. Vertical design should account for the likelihood of large truck overturning or load shifting, which can sometimes be induced by excessive cross slopes. While these types of incidents account for few personal injury crashes per year, they can produce property damage and create delay and congestion while the intersection is cleared. Many factors can contribute to truck overturning, and both horizontal and vertical design components contribute simultaneously.

6.8.7.1 Profiles

The vertical design of a roundabout begins with the development of the approach roadway and central island profiles. The development of each profile is an iterative process that involves tying the elevations of the approach roadway profiles into a smooth profile around the central island.

Each approach profile should be designed to the point where the approach baseline intersects with the central island. A profile for the central island is then developed that passes through these four points (in the case of a four-legged roundabout). The approach roadway profiles are then readjusted as necessary to meet the central island profile. The shape of the central island profile is generally in the form of a sine curve. Examples of how the profile is developed can be found in Exhibit 6-75, which consist of a sample plan, profiles on each approach, and a profile along the central island, respectively. Note where the four points of the approach roadway baseline are identified on the central island profile.

In addition to the approach and central island profiles, creating an additional profile around the inscribed circle of the roundabout and/or along outer curbs

Exhibit 6-75
Sample Central Island Profile

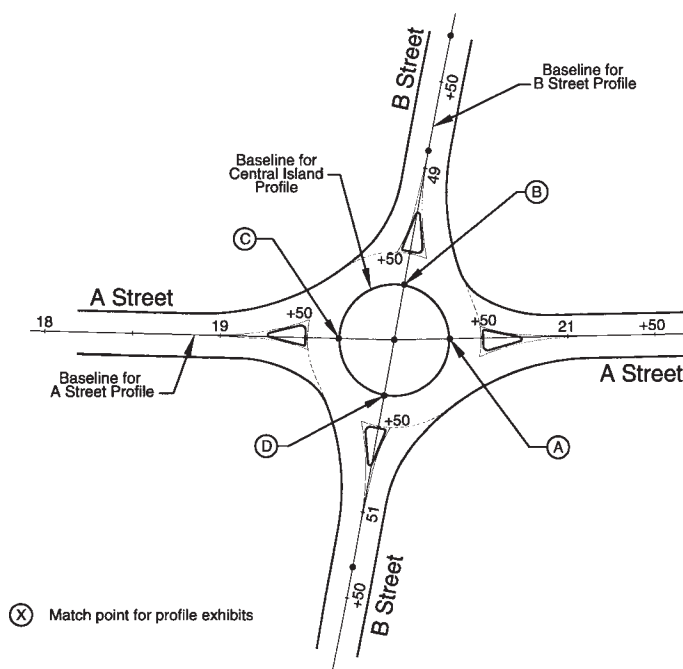
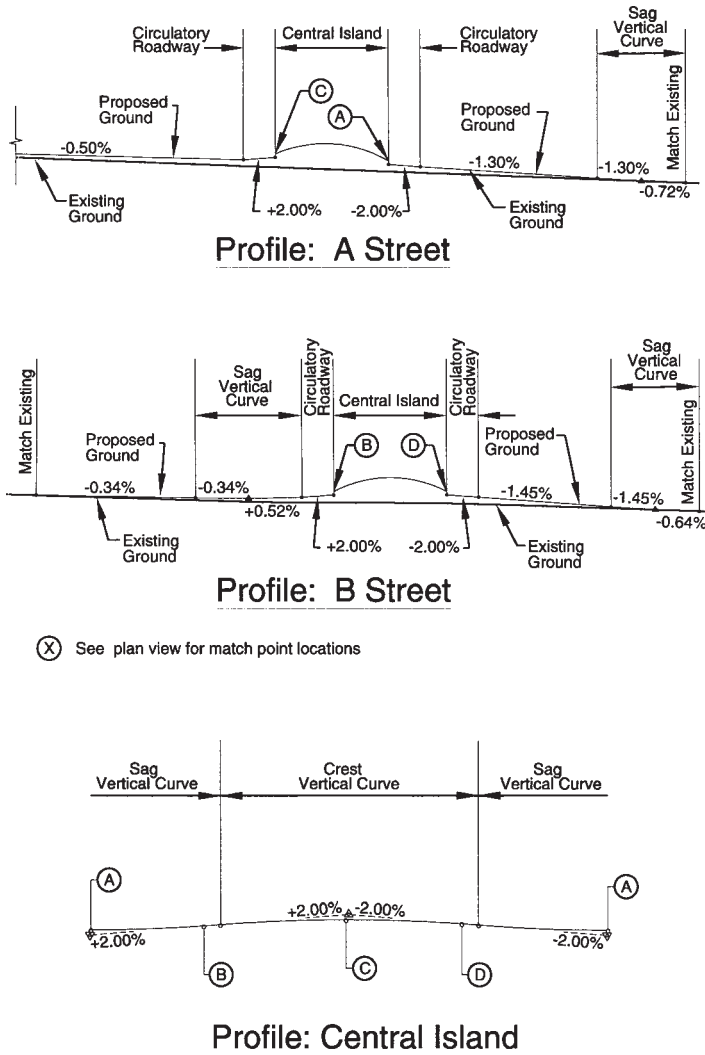

Exhibit 6-75 (cont.)
Sample Central Island Profile



may also be beneficial to the engineer, reviewers, and contractor. The combination of the central island, inscribed circle, and curb profiles allows for quick verification of cross slopes and drainage and provides additional information to contractors for staking out the roundabout.

6.8.7.2 Single-Lane Roundabout Circulatory Roadway

As a general practice, a cross slope of 2% away from the central island should be used for the circulatory roadway on single-lane roundabouts. This technique of sloping outward is recommended for four main reasons:

1. It promotes safety by raising the elevation of the central island and improving its visibility,
2. It promotes lower circulating speeds,
3. It minimizes breaks in the cross slopes of the entrance and exit lanes, and
4. It helps drain surface water to the outside of the roundabout (3, 25).

Negative superelevation (-2%) should generally be used for the circulatory roadway.

The outward cross-slope design means vehicles making through and left-turn movements must negotiate the roundabout at negative superelevation. Excessive negative superelevation can result in an increase in single-vehicle crashes and loss-of-load incidents for trucks, particularly if speeds are high. However, in the intersection environment, drivers will generally expect to travel at slower speeds and will accept the higher side force caused by reasonable adverse superelevation (24).

6.8.7.3 Multilane Roundabout Circulatory Roadway

There are a variety of possible methods for the vertical design of a circulatory roadway within a multilane roundabout. However, two primary methods are typically used: outward sloping and crowned circulatory roadways:

Outward sloping. This is the most common type of vertical design for roundabouts in the United States. The circulatory roadway is graded independently of the rest of each approach, with the circulatory roadway outward draining with a grade of 1.5 to 3%. This is most practical in relatively flat terrain, as hilly terrain may require warping of the profile and possibly an alternative vertical design.

Crowned circulatory roadway. The circulatory roadway is crowned with approximately two-thirds of the width sloping toward the central island and one-third sloping outward. This may alternatively be reversed so that half of the circulatory roadway slopes toward the central island. The maximum recommended cross slope is 2%. Asphalt paving surfaces are recommended under this type of application to produce a smoothed crown shape. This method is primarily intended for consideration at multilane roundabouts. Other vertical design options include:

- *Existing grade lines (non-planar).* It is often desirable to use the existing ground elevation, to the extent possible, to reduce overall changes in vertical profile. At the intersection of two major roadways, this may result in two crown lines crossing one another, with the circulating roadway warping between the crown lines to provide the drainage. This is no different from a major signalized crossroad. However, it can affect driver comfort and lane discipline through the roundabout.
- *Tilted plane.* This method allows the existing road grade line to be maintained. An example is where two roadways currently cross with 2% grade on Road A and 3% grade on Road B. The roundabout should be designed as a plane surface sitting on those two grade lines. The uphill sides of the circulating roadway would have inward slopes of +2% and +3% respectively, with the downhill sections having (negative) crossfalls of -2 and -3%. The section with the steepest crossfall could be modified slightly so that no slope exceeded -2.5%.
- *Folded plane.* The folded plane is a similar concept to the tilted plane, where one direction follows the ruling grade **and** the crown line of one of the roads. The plane of the circulating roadway is folded about the grade line of the road. The ruling grade line can be flat through to about 10%. In a flat area, the two folded planes would typically have a grade differential of 4 to 5%.

6.8.7.4 Truck Aprons

Exhibit 6-76 and Exhibit 6-77 provide typical sections for roundabouts with a truck apron. Where truck aprons are used, the slope of the apron should generally

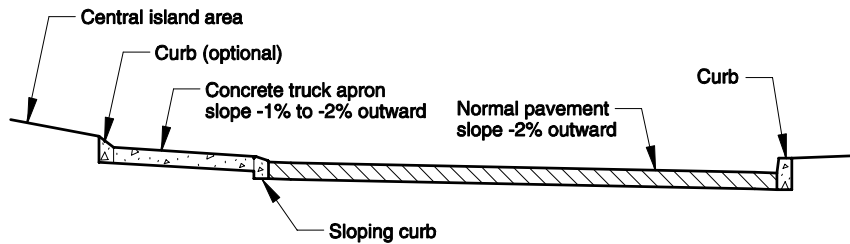

Exhibit 6-76
Typical Section with a
Truck Apron

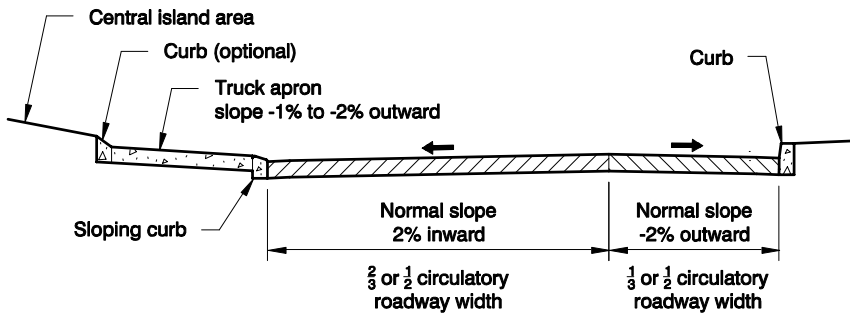

Exhibit 6-77
Typical Section with Crowned
Circulatory Roadway

be no more than 2%; greater slopes may increase the likelihood of loss-of-load incidents. Within the United States, truck aprons are commonly sloped toward the outside of the roundabout. However, some locations have also implemented roundabouts with truck aprons sloped inward (toward the central island) to minimize water shedding across the roadway and to minimize load shifting in trucks. Agencies using this strategy report that additional catch basins were provided along the edge of the central island to collect water and pipe it under the circulatory roadway to connect in with the drainage system along the roundabout periphery.

The vertical design of the truck apron should be reviewed to confirm that there is sufficient clearance for low-boy type trailers, some of which may have only 6 to 8 in. between the roadway surface and bottom of the trailer. The vertical clearance can be reviewed by drawing a chord across the apron in the position where the trailer would sweep across. In some cases the warping of the profile along the circulatory roadway can create high spots that could cause trailers to drag or scrape along the truck apron.

Between the truck apron and the circulatory roadway, a curb is required to accommodate a change in vertical elevation. As shown in Exhibit 6-76 and Exhibit 6-77, the truck apron elevation should be higher than the circulatory roadway to discourage passenger vehicles from using the apron. A variety of different curb shapes are currently used throughout the United States to meet the needs of individual state agency specifications and needs. To discourage passenger car use of the apron, a curb shape with a 2 to 3 in. vertical reveal and then sloped top has historically been common practice. However, concerns regarding truck tires rubbing against the vertical face of the curb and maintenance issues with snow plowing have caused some agencies to use a modified sloping curb type that contains no vertical component. Several examples of these sloping curb shapes are illustrated in Exhibit 6-78.

Roundabouts: An Informational Guide

Exhibit 6-78
Examples of Sloping Truck Apron Curb Shapes Used in the United States

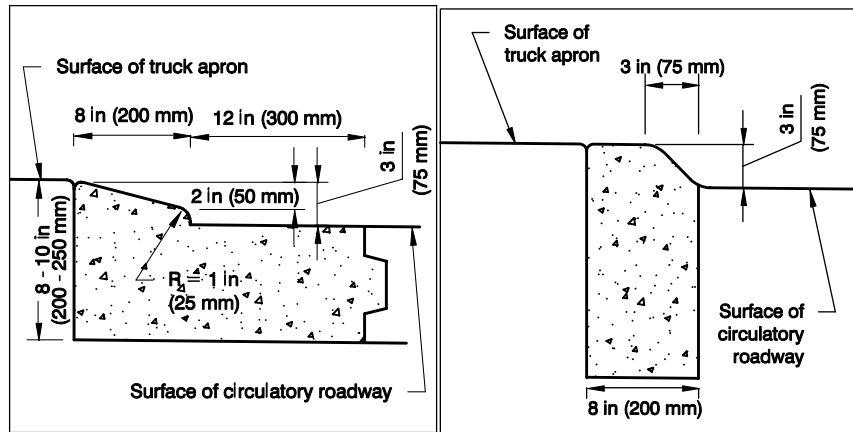

(a) Maryland State Highway Administration (26) (b) Kansas Department of Transportation (27)

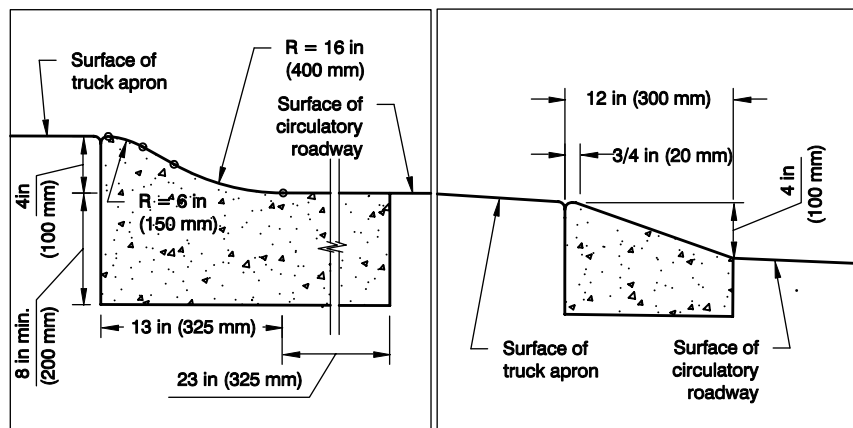

(c) Wisconsin Department of Transportation (28) (d) New York State Department of Transportation (29)

Avoid locating roundabouts in areas where grades through the intersection are greater than 4%.

6.8.7.5 Locating Roundabouts on Grades

It is generally not desirable to place roundabouts in locations where grades through the intersection are greater than 4%, although roundabouts have been installed on grades of 10% or more. Installing roundabouts on roadways with grades lower than 3% is generally not problematic (25). At locations where a constant grade must be maintained through the intersection, the circulatory roadway may be constructed on a constant-slope plane. This means, for instance, that the cross slope may vary from +3% on the high side of the roundabout (sloped toward the central island) to -3% on the low side (sloped outward). Note that the central island cross slopes will pass through a level at a minimum of two locations for roundabouts constructed on a constant grade.

Care is needed when designing roundabouts on steep grades. On approach roadways with grades steeper than -4%, it is more difficult for entering drivers to slow or stop on the approach. At roundabouts on crest vertical curves with steep approaches, a driver's sight lines may be compromised, and the roundabout may violate driver expectancy. However, under the same conditions, other types of at-grade intersections often will not provide better solutions. Therefore, the

roundabout should not necessarily be eliminated from consideration at such a location. Rather, the intersection should be relocated or the vertical profile modified, if possible.

Grades in the vicinity of a roundabout need to reflect the terrain of the area. Roundabouts in hilly areas can be expected to have steeper grades on approaches, departures, and on the circulatory roadway. Steep gradients at entries and exits should be avoided or flattened at the roundabout approaches. Care must be taken by the engineer to ensure that the user is able to safely enter and exit the circulatory roadway. This area requires pavement warping or cross slope transitions to provide an appropriate cross slope transition rate through the entire transition area. Care must also be taken with grading of the vertical profile to ensure that adequate sight distance is provided for the intersection and entry.

Entry grade profiles (approximately two car lengths from the outer edge of the circulatory roadway) should not exceed 3%, with 2% being the desirable maximum. It is desirable to match the exit grades and the entry grades; however, the exit grade may be steeper but should not exceed 4%. Adjustments to the circulatory roadway cross slope may be required to meet these criteria but should be balanced with the effects on the circulatory roadway (7).

6.8.7.6 Drainage

With the circulatory roadway sloping away from the central island, inlets will generally be placed on the outer curb line of the roundabout. Inlets can usually be avoided on the central island for a roundabout designed on a constant grade through an intersection. As with any intersection, care should be taken to ensure that low points and inlets are placed upstream of crosswalks.

6.8.8 MATERIALS AND DESIGN DETAILS

6.8.8.1 Curb Types

A generally vertically faced curb, typically 6 in. (150 mm) high, is recommended around the outside of the roundabout, the central island, and the splitter islands since one of the important elements of these features is to force deflection in vehicles traveling through the roundabout. If the curb is considered to be traversable by drivers, this effect may be lessened. A vertically faced curb on the approach and in the splitter island also provides better protection for the pedestrian. However, most roundabouts must also be designed to accommodate large trucks. Additional detail on curb types around the edge of the truck apron is provided in Section 6.8.7.4.

6.8.8.2 Circulatory Roadway Pavement Type

Asphalt concrete and Portland cement concrete pavements have been used for construction of roundabouts throughout the United States. The majority of roundabouts, both domestic and internationally, use asphalt concrete paving. The decision of whether to use asphalt concrete or Portland cement concrete will depend on local preferences and the pavement type of the approach roadways. Portland cement concrete generally has a longer design life and holds up better

under truck traffic. However, few agencies have reported problems with rutting on well-constructed asphalt concrete pavement.

Constructability is also a consideration in choosing pavement type. Construction of a roundabout under traffic is typically easier when using asphalt concrete pavement. It is also typically easier to construct a smooth crown line using asphalt concrete if the circulatory roadway is crowned.

If Portland cement concrete pavement is used, joint patterns should be concentric and radial to the circulating roadway within the roundabout. Ideally the joints should not conflict with pavement markings within the roundabout, although concrete panel sizes may control this. On multilane roundabouts, circumferential joints within the circulating roadway should follow the lane edges to the extent practical. Specifications for jointing and dowel details tend to vary by location, and the local jurisdiction should be consulted for requirements. Additional information and publications regarding jointing are available from the American Concrete Paving Association (30). Example jointing plans are shown in Exhibit 6-79 and Exhibit 6-80.

Exhibit 6-79
Example Concrete Jointing Patterns

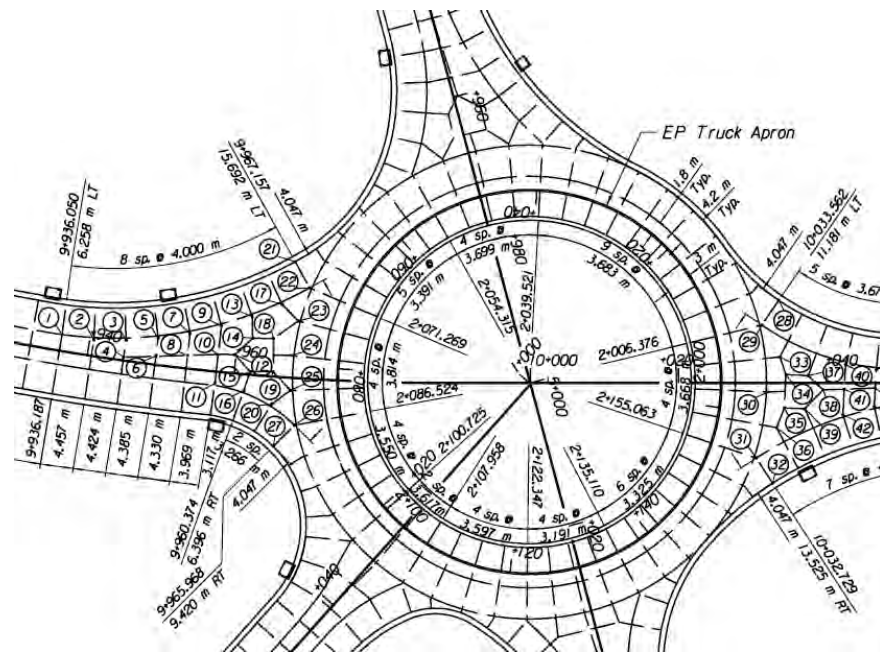

Source: Kansas Department of Transportation

Cracking has been found to be a problem in some Portland cement concrete roundabouts, particularly around the outside of the circulating roadway in the vicinity of the outside curbs and splitter islands, so special care needs to be taken to provide the necessary relief. One possible option is to isolate the circulating roadway with an expansion joint and construct special monolithic sections in key areas.

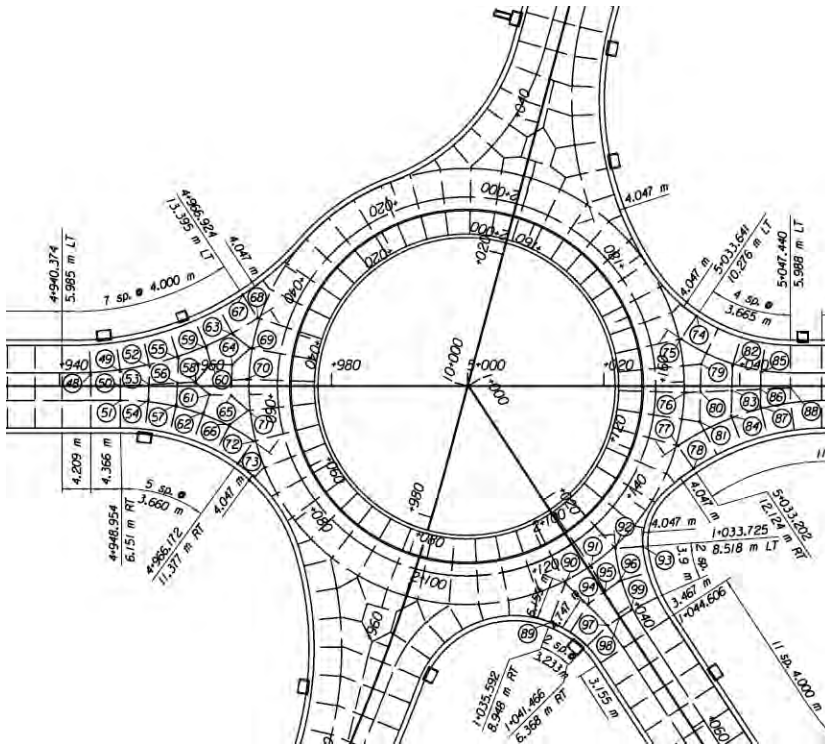

Source: Kansas Department of Transportation

Exhibit 6-80

Example Concrete Jointing Patterns

6.8.8.3 Truck Apron Material

For the truck apron, concrete pavement or concrete with a brick paver surface is commonly used. Other options include using large [4 in (100 mm)] river rocks embedded in concrete that can be traversed by trucks but are uncomfortable for smaller vehicles or pedestrians. A geogrid-type material can also be used to provide a more landscaped appearance but hold up to occasional encroachment by large trucks. The material used for the truck apron should be selected so as to not look like the sidewalk. This will help to keep pedestrians off the truck apron and central island. If the truck apron is constructed under traffic, high early strength concrete should be used to minimize the amount of down time for the intersection.

6.8.8.4 Material Selection

Visibility of the various design elements through variations in material, color, and/or texture should be considered in the selection of materials for splitter island curbs and outside curbs, pavement, and truck apron. Curbs should be of a material or color that contrasts with the pavement material to provide adequate visibility to approaching drivers. For example, the use of standard concrete curbs adjacent to concrete pavement may not allow a driver to easily discern the location of the curbs and the geometric curvature of the entry to the roundabout on approach.

The use of enhanced delineation adjacent to the curb (by use of additional markings, reflectors, and other markers) may also be applied where contrasting materials cannot be used. However, these types of supplemental delineators are typically less desirable due to maintenance requirements.

6.9 CLOSELY SPACED ROUNDABOUTS

It is sometimes desirable to consider the operation of two or more roundabouts in close proximity to each other. In these cases, the expected queue length at each roundabout becomes important. Exhibit 6-81(a) presents an example of closely spaced T-intersections. The engineer should compute the 95th-percentile queues for each approach to check that sufficient queuing space is provided for vehicles between the roundabouts. If there is insufficient space, then drivers will occasionally queue into the upstream roundabout and may cause it to lock.

Closely spaced roundabouts may improve safety by calming the traffic on the major road. Drivers may be reluctant to accelerate to the expected speed on the arterial if they are also required to slow again for the next close roundabout. This may benefit nearby residents.

Roundabouts may also provide benefit for other closely spaced intersections. Short delay and queuing for vehicles at roundabouts allow for tighter spacing of

Closely spaced roundabouts may have a traffic calming effect on the major road.

Exhibit 6-81
Examples of Closely Spaced
Roundabouts



(a) France



(b) Livingston County, Michigan

intersections without providing a significant operational detriment to the other intersection, provided that adequate capacity is available at both intersections. Exhibit 6-81(b) illustrates two closely spaced roundabouts at an interchange ramp and nearby frontage road. The two roundabouts work together as a system to effectively serve the traffic demands. Due care must be given to a system of roundabouts with this complexity to ensure that the design objectives are met, that each approach leg has sufficient capacity, and that the lane numbers and arrangements work together to allow a driver to intuitively navigate the intersection without lane changes or weaving.

6.10 INTERCHANGES

Freeway ramp junctions with arterial roads are potential candidates for use of roundabouts at the ramp terminals. This is especially so if the subject interchange typically has a high proportion of left-turn flows from the off-ramps and to the on-ramps during certain peak periods, combined with limited queue storage space on the bridge crossing, off-ramps, or arterial approaches. In such circumstances, roundabouts operating within their capacity are particularly suited to solving these problems when compared with other forms of intersection control.

6.10.1 DIAMOND INTERCHANGE

The most common type of interchange that incorporates roundabouts is a standard diamond interchange with a roundabout at each side of the freeway (see Exhibit 6-82 and Exhibit 6-83). A bridge is used for the crossroad over the freeway or for a freeway to cross over the minor road. Again, two bridges may be used when the freeway crosses over the minor road.

The use of two roundabouts at the ramp terminals provides some advantages over the single-point interchange. The use of two roundabouts offers flexibility in locating the ramp terminal intersections to minimize affects on retaining wall structures and improve the ramp geometry approaching the roundabout. It may also provide greater flexibility for adding lanes to the roundabout at a later date to increase the interchange capacity.

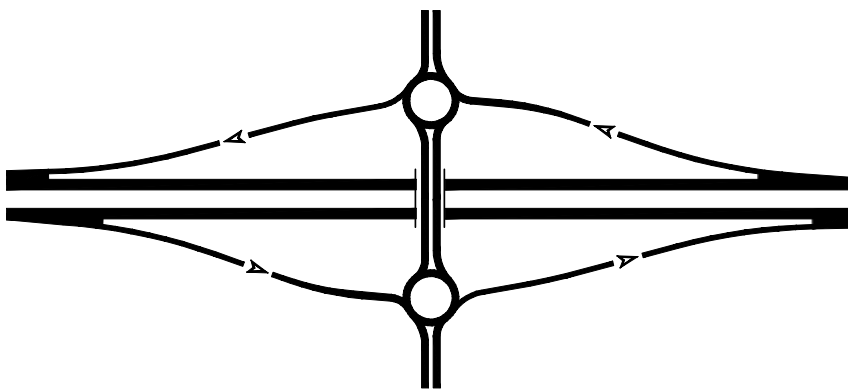
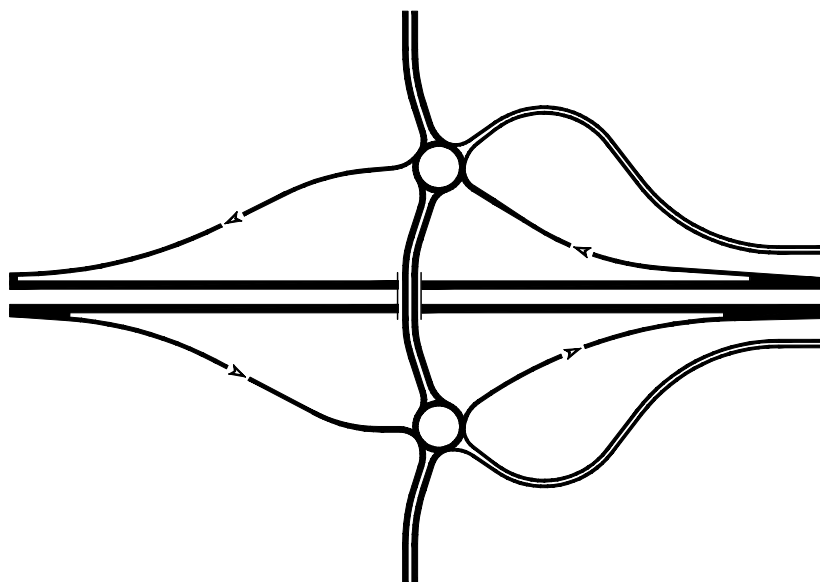

Exhibit 6-82
Conceptual Diamond
Interchange

Source: Adapted from Arizona Department of Transportation (31)

Roundabouts: An Informational Guide

Exhibit 6-83
Conceptual Diamond
Interchange with
Frontage Roads



Source: Arizona Department of Transportation (31)

Diamond interchanges using roundabouts at the terminals have been successfully used to defer the need for bridge widening.

This interchange form has been used successfully in some cases to defer the need to widen bridges. Unlike signalized ramps that may require exclusive left-turn lanes across the bridge and extra queue storage, this type of roundabout interchange exhibits very little queuing between the intersections since these movements are almost unopposed. Therefore, the approach lanes across the bridge can be minimized.

The actual roundabouts can have two different shapes or configurations. The first configuration is a conventional one with circular central islands. This type of configuration is recommended when it is desirable to allow U-turns at each roundabout or to provide access to legs other than the cross street and ramps. An example is shown in Exhibit 6-84.

Exhibit 6-84
Example of Interchange with
Circular Central Islands



Wisconsin

The second configuration uses raindrop-shaped central islands that preclude some turns at the roundabout; examples are shown in Exhibit 6-85 and Exhibit 6-86. This configuration is best used when ramps (and not frontage roads) intersect at the roundabout. A raindrop central island can be considered to be a circular shape blocked at one end. In this configuration, a driver wanting to make a U-turn has to drive around both raindrop-shaped central islands. The raindrop configuration has an advantage in that it makes wrong-way turns into the off-ramps more difficult and removes excess pavement on the circulatory roadway that would only service U-turn maneuvers. In doing so, it also removes the yielding condition on the leg coming from the upstream roundabout, which virtually eliminates the likelihood of queuing between the ramp terminals. On the other hand, the lack of operational consistency with other roundabout entries (where one entry is not required to yield) is one of the primary concerns causing some engineers to advocate the use of a conventional roundabout shape over the raindrop shape. In addition, if a raindrop-shaped roundabout is designed poorly, drivers may be traveling faster than they should to negotiate the next roundabout safely.

Raindrop central islands make wrong-way movements more difficult, but require navigating two roundabouts to make a U-turn.



Carmel, Indiana



Avon, Colorado

Exhibit 6-85

Example of a Compact Interchange with Raindrop-Shaped Central Islands

Exhibit 6-86

Example of Interchange with Raindrop-Shaped Central Islands

6.10.2 SINGLE-POINT DIAMOND INTERCHANGE

Another type of diamond interchange is a single-point diamond interchange. This incorporates a single large-diameter roundabout centered over or under a freeway. The ramps connect directly into the roundabout, as do the legs from the crossroad. This is illustrated in Exhibit 6-87.

Exhibit 6-87

Single-Point Diamond Interchange with One Roundabout

The freeway may either go over or under the circulatory roadway.

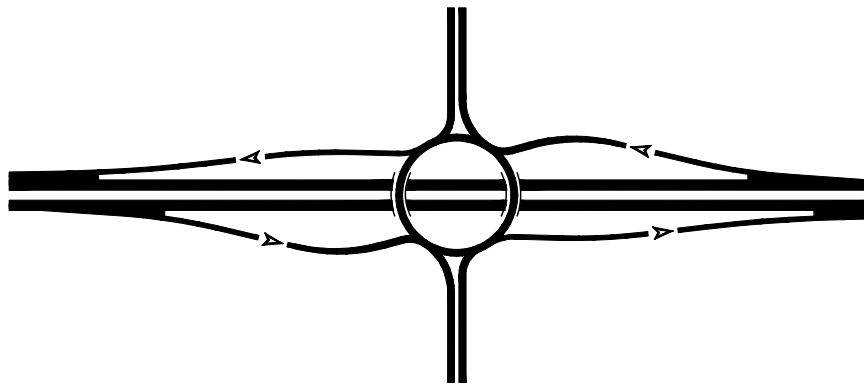

Source: Arizona Department of Transportation (31)

This type of interchange requires two bridges. If the roundabout is above the freeway as shown in Exhibit 6-87, then the bridges may be curved. Alternatively, if the freeway goes over the roundabout, then four shorter bridges or two longer bridges may be required, as shown in Exhibit 6-88. The number of bridges will depend on the optimum span of the type of structure compared with the inscribed diameter of the roundabout island and on whether the one bridge is used for both freeway directions or whether there is one bridge for each direction. The road cross section will also influence the design decision.

Exhibit 6-88

Example Split Diamond Single-Point Interchange



Newton, Kansas

6.11 ACCESS MANAGEMENT

Access points near an intersection or along an arterial create additional conflicts within the roadway system that affect operations and safety. Managing access points can improve the overall effectiveness of the system by streamlining the roadway operations and reducing the number of conflicts. Roundabouts can provide a useful tool within an access management program to provide U-turn opportunities at the intersections, thereby allowing for a reduction of full access points along the roadway segment. However, within the vicinity of an individual roundabout intersection, property access must also be carefully evaluated.

Access management at roundabouts follows many of the principles used for access management at conventional intersections. For public and private access points near a roundabout, two scenarios commonly occur:

- Access into the roundabout itself or
- Access near the roundabout.

6.11.1 ACCESS INTO THE ROUNDABOUT

It is preferable to avoid locating driveways where they must take direct access to a roundabout. Driveways introduce conflicts into the circulatory roadway, including acceleration and deceleration. Traditional driveway designs do not discourage wrong way movements as a splitter island does.

Nonetheless, site constraints sometimes make it necessary to consider providing direct access into a roundabout. Exhibit 6-89 shows examples where one or two residential houses have been provided direct access into a roundabout. These driveways have been designed with traditional concrete driveway aprons to provide a clear visual and tactile indication that these are private driveways not to be confused with public roadways.

For a driveway to be located where it takes direct access to the circulatory roadway of a roundabout, it should satisfy the following criteria:

- No alternative access point is reasonable.
- Traffic volumes are sufficiently low to make the likelihood of errant vehicle behavior minimal. Driveways carrying the trip generation associated with a very small number of single-family houses are typically acceptable; driveways with higher traffic volumes should be designed as a regular approach with a splitter island. In addition, if a high proportion of unfamiliar drivers are expected at the driveway, the engineer should consider providing more positive guidance.
- The driveway design should enable vehicles to exit facing forward with a hammerhead design or other area on-site where vehicles can turn around. Driveways that only allow backing maneuvers into the roundabout should be discouraged in all but very low-volume environments.
- The driveway design should enable proper intersection sight distance from the driveway location and adequate stopping sight distance for vehicles approaching the driveway traveling along the primary roadway.

 Roundabouts: An Informational Guide

Exhibit 6-89
 Example of Residential
 Driveways into Circulatory
 Roadway

(a) Santa Barbara, California



(b) Voorheesville, New York

6.11.2 ACCESS NEAR THE ROUNDABOUT

Public and private access points near a roundabout often have restricted operations due to the channelization of the roundabout. Driveways between the crosswalk and entrance line complicate the pedestrian ramp treatments and introduce conflicts in an area critical to operations of the roundabout. Exhibit 6-90 shows examples of driveway challenges of this type. Driveways blocked by the splitter island will be restricted to right-in/right-out operation and are best avoided altogether unless the impact is expected to be minimal and/or no reasonable alternatives are available.

The ability to provide an access point that allows all ingress and egress movements (hereafter referred to as *full access*) is governed by a number of factors:

- *The capacity of the minor movements at the access point.* A standard unsignalized intersection capacity analysis should be performed to assess the operational effectiveness of an access point with full access. Unlike the platooned flow typically downstream of a signalized intersection, traffic passing in front of an access point downstream of a roundabout will be more randomly distributed. As a result, an access point downstream of a roundabout may have less capacity and higher delay than one



(a) Driveway between crosswalk and roundabout (Bend, Oregon)



(b) Driveway aligned with crosswalk (Sammamish, Washington)



(c) Driveway reconfiguration (Clearwater, Florida)

Exhibit 6-90
Example of Driveway
Challenges near Roundabout

downstream of a traffic signal. Queuing from nearby intersections (the roundabout or others nearby) should be checked to see if the operation of the access point will be affected.

- *The need to provide left-turn storage on the major street to serve the access point.* For all but low-volume driveways it is often desirable to provide separate left-turn storage for access points downstream of a roundabout to minimize the likelihood that a left-turning vehicle will block the major street traffic flow. If quantification is desired, a probability analysis can be used to determine the likelihood of an impeding left-turning vehicle, and a queuing analysis can be used to determine the length of the queue behind the impeding left-turning vehicle. If the number of left-turning vehicles is sufficiently small and/or the distance between the access point and the roundabout is sufficiently large, a left-turn pocket may not be necessary.
- *The available space between the access point and the roundabout.* Exhibit 6-91 presents a figure showing typical dimensions associated with a roundabout and left-turn storage for a downstream minor street. As the figure demonstrates, a minimum distance is required to provide adequate roundabout splitter island design and left-turn pocket channelization. In addition, access is restricted along the entire length of the splitter island and left-turn pocket channelization.

Exhibit 6-91
Typical Dimensions for
Left-Turn Access near
Roundabouts

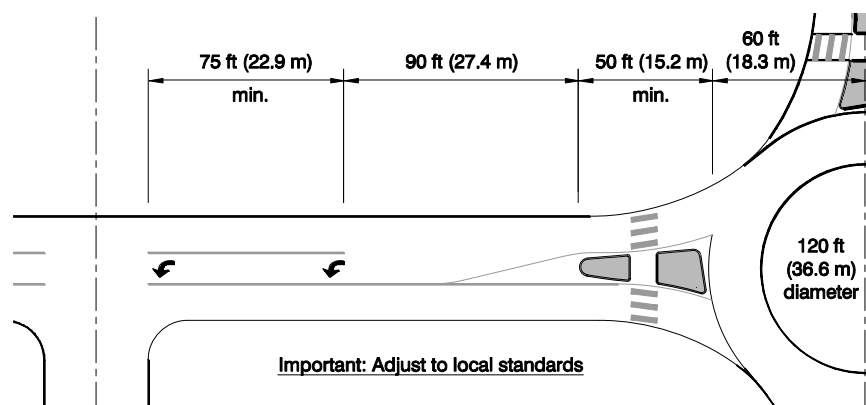

- *Sight distance needs.* A driver at the access point should have proper intersection sight distance and should be visible when approaching or departing the roundabout, as applicable.

6.12 STAGING OF IMPROVEMENTS

When projected traffic volumes indicate that a multilane roundabout is required for future year conditions, engineers should evaluate the duration of time that a single-lane roundabout would operate acceptably before requiring

additional lanes. Where a single-lane roundabout will be sufficient for much of its design life, engineers should evaluate whether it is best to first construct a single-lane roundabout until traffic volumes dictate the need for expansion to a multi-lane roundabout. One reason to stage the construction of a multi-lane roundabout is that future traffic predictions may never materialize due to the significant number of assumptions that must be made when developing volume estimates for a 20- or 30-year design horizon.

Single-lane roundabouts are generally simpler for motorists to learn and are more easily accepted in new locations. This, combined with fewer vehicle conflicts, should result in a better overall crash experience and allow for a smooth transition into the ultimate multi-lane build-out of the intersection. Single-lane roundabouts introduce fewer conflicts to pedestrians and provide increased safety benefits and usability to pedestrians by minimizing the crossing distance and limiting their exposure time to vehicles while crossing an approach. Single-lane roundabouts are also safer and easier for bicyclists to use, making it more likely that cyclists will be able to use the roundabout like other vehicles.

When considering an interim single-lane roundabout, the engineer should evaluate the right-of-way and geometric needs for both the single-lane and multi-lane configurations. Consideration should also be given to the future construction staging for the additional lanes. Discussed below are two ways to expand from a single-lane to a double-lane roundabout.

6.12.1 EXPANSION TO THE OUTSIDE

Expansion to the outside involves adding any necessary lanes for the ultimate configuration to the outside of the interim roundabout configuration, with the central island and splitter islands remaining the same in both interim and ultimate configurations. Assuming that the right-of-way was purchased for the ultimate design, the interim sidewalks and landscaping could also be constructed in their ultimate location.

When using this option, care should be taken to provide adequate geometric features, including entry and splitter island design, to ensure that speed reduction and adequate natural paths will be provided at build-out. In preparing for this type of construction staging, it may be appropriate to initially design the roundabout for the ultimate double-lane condition to ensure adequate geometry and then remove the outside lanes from the design to form the initial single-lane roundabout. It is also helpful to evaluate the ultimate footprint of the roundabout to reserve right-of-way to accommodate the future widening.

This configuration has the potential to be less of a disruption to vehicular traffic during the expansion since the majority of the improvements are on the outside of the roadway. Drainage structures will typically need to be relocated, and the new outside curb lines will need to be constructed first. The original curb line is then demolished and replaced with pavement. The original pavement markings should be ground off and final markings and signs should be placed before the additional lanes of traffic are opened for use. In locations where concrete pavement

is used, grinding off of the pavement markings may leave a permanent mark on the roadway surface that may be confusing to drivers. Therefore, particular care should be taken in locating the markings in the interim configuration where concrete paving is used to minimize the need for relocation of the markings in the ultimate configuration.

6.12.2 EXPANSION TO THE INSIDE

Expansion to the inside involves adding any necessary lanes for the ultimate configuration to the inside of the interim roundabout configuration, with the outer curbs and inscribed circle diameter remaining the same in both interim and ultimate configurations. This allows the engineer to set the outer limits of the intersection during the initial construction and limits the future construction impacts to surrounding properties during widening, as sidewalks and outer curb lines will not typically require adjustment.

As with the other option, the roundabout is initially designed for the ultimate multilane configuration. However, the modification to a single-lane design is done by providing wide splitter islands and an enlarged central island that occupy the space required for the inside travel lanes. Future expansion to the multilane roundabout is accomplished by reducing the width of the splitter islands and widening on the inside of the existing travel lanes. Typically, the splitter islands, central island curbing, and truck apron would require replacement. This type of expansion is illustrated in Exhibit 6-92.

This process typically requires short-term lane closures and therefore may be best accomplished by working on one approach at a time and implementing localized detours for the approach that is undergoing demolition. The remainder of the intersection can continue to operate normally. Additionally, if demolition is staged from the entry lanes of the intersection, the exit on the leg where demolition is occurring may be able to remain open. Once the old splitter island is removed, work on forming and pouring concrete for the new splitter island can be accomplished from the new inside lane developed as part of the initial demolition. This may allow for the original outside entry lane to be re-opened to traffic, subject to flagging or other necessary traffic control. Once the new splitter island has been constructed and the additional roadway pavement is placed for an approach, the new inside lanes should remain coned off until the remaining approaches have been completed and the final markings and signing have been placed for the full intersection.

In cases where the interim configuration of the roundabout is expected to be in place for a limited time before the ultimate configuration is implemented, it may be possible to construct the splitter island in its ultimate location with a narrower width and add supplemental pavement markings to channelize the single-lane approach width for the interim configuration. This would minimize the reconstruction of the splitter island for the future configuration; however, the striped portion of the splitter island would require ongoing maintenance and may not be as effective at providing vehicle deflection at the roundabout entrance.

Exhibit 6-92
Staged Multilane Roundabout

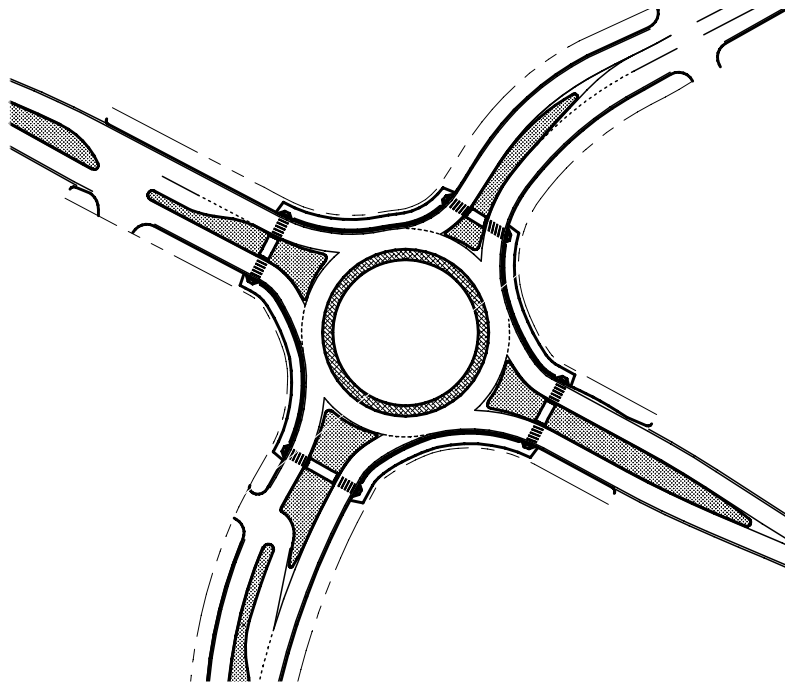

(a) Staged Multilane Roundabout: Interim Configuration

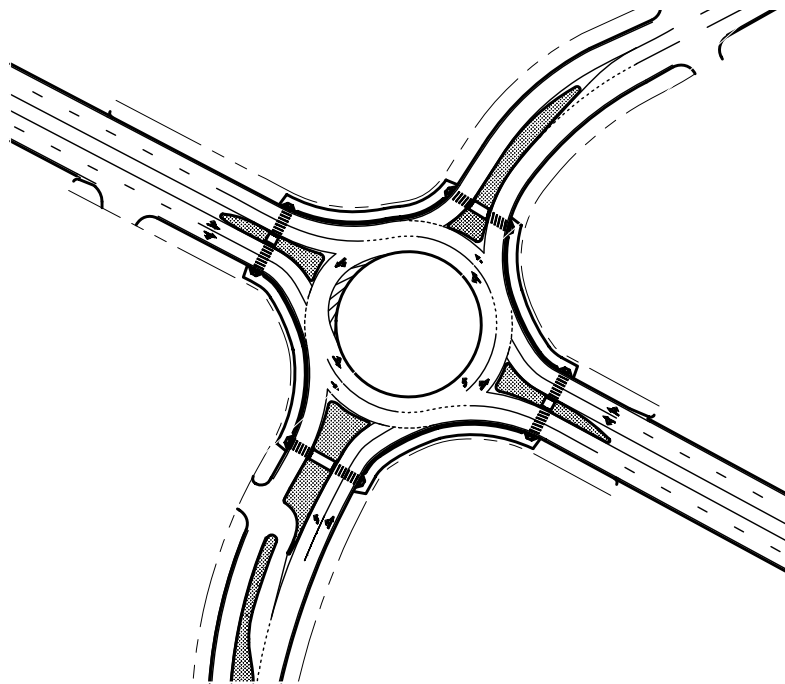

(b) Staged Multilane Roundabout: Ultimate Configuration

6.13 REFERENCES

1. Tian, Z. Z., F. Xu, L. A. Rodegerdts, W. E. Scarbrough, B. L. Ray, W. E. Bishop, T. C. Ferrara, and S. Mam. *Roundabout Geometric Design Guidance*. Report No. F/CA/RI-2006/13. Division of Research and Innovation, California Department of Transportation, Sacramento, CA, June 2007.
2. Rodegerdts, L., M. Blogg, E. Wemple, E. Myers, M. Kyte, M. Dixon, G. List, A. Flannery, R. Troutbeck, W. Brilon, N. Wu, B. Persaud, C. Lyon, D. Harkey, D. Carter. *NCHRP Report 572: Roundabouts in the United States*. Transportation Research Board of the National Academies, Washington, D.C., 2007.
3. Queensland Department of Main Roads (QDMR). *Relationships between Roundabout Geometry and Accident Rates*. Infrastructure Design of the Technology Division of QDMR, Queensland, Australia, April 1998.
4. *A Policy on Geometric Design of Highways and Streets*. AASHTO. Washington, D.C., 2004.
5. Pein, W. E. *Trail Intersection Design Guidelines*. Prepared for State Bicycle/Pedestrian Program, State Safety Office, Florida Department of Transportation. Highway Safety Research Center, University of North Carolina, September 1996.
6. Maycock, G. and R. D. Hall *Crashes at Four-Arm Roundabouts*. TRRL Laboratory Report LR 1120. Transport and Road Research Laboratory, Crowthorne, England, 1984
7. *Roundabout Guide*. Wisconsin Department of Transportation, April 2008.
8. Kittelson & Associates, Inc., and TranSystems Corporation. *Kansas Roundabout Guide: A Supplement to FHWA's Roundabouts: An Informational Guide*. Kansas Department of Transportation, Topeka, Kansas, October 2003.
9. *Geometric Design of Roundabouts*. TD 16/07. Department of Transport, United Kingdom, August 2007.
10. Kimber, R. M. *The Traffic Capacity of Roundabouts*. TRRL Laboratory Report LR 942. Transport and Road Research Laboratory, Crowthorne, England, 1980.
11. McCulloch, H. *The Roundabout Design Process—Simplified*. National Roundabout Conference. Kansas City, Missouri, 2008. www.teachamerica.com/RAB08/RAB08S3BMcCulloch/index.htm. Accessed July 30, 2009.
12. Institute of Transportation Engineers. *Enhancing Intersection Safety through Roundabouts: An ITE Informational Report*. ITE, Washington, D.C., 2008.
13. Fortuijn, L. G. H. and V. F. Harte. "Meerstrooksrotondes: verkenning can nieuwe vormen" ("Turbo-roundabouts: A well-tried concept in a new guise"). *Verkeerskundige werkdagen 1997*, CROW, Ede., Netherlands, 1997.
14. Sawers, C. *Mini-Roundabouts: A Definitive Guide for Small and Mini-Roundabouts (Right Hand Drive Version)*. Moor Value Ltd., United Kingdom, 2007.
15. Sawers, C. *Mini-Roundabouts: Getting Them Right!* Euro-Marketing Communications, Canterbury, Kent, United Kingdom, 1996.

16. Brilon, W. and L. Bondzio. *Untersuchung von Mini-Kreisverkehrsplaetzen (Investigation of Mini-Roundabouts)*. Ruhr-University, Bochum, Germany, 1999.
17. "TD 54/07, Design of Mini-Roundabouts." *Design Manual for Roads and Bridges*, Volume 6, Road Geometry; Section 2, Junctions, Part 2. Department for Transport, United Kingdom, August 2007.
18. Department for Transport and the County Surveyors Society. *Mini Roundabouts, Good Practice Guidance*. Department for Transport, United Kingdom, November 27, 2006. www.dft.gov.uk/pgr/roads/tss/gpg/miniroundabouts/goodpractice.pdf. Accessed July 23, 2009.
19. Fambro, D. B., K. Fitzpatrick, and R. J. Koppa. *NCHRP Report 400: Determination of Stopping Sight Distances*. National Cooperative Highway Research Program, Transportation Research Board of the National Academies, Washington, D.C., 1997.
20. Harwood, D. W., J. M. Mason, R. E. Brydia, M. T. Pietrucha, and G. L. Gittings. *NCHRP Report 383: Intersection Sight Distances*. National Cooperative Highway Research Program, TRB, National Research Council, Washington, D.C., 1996.
21. Staplin, L., K. Lococo, S. Byington, and D. Harkey. *Highway Design Handbook for Older Drivers and Pedestrians*. Report No. FHWA-RD-01-103. FHWA, Washington, D.C., May 2001.
22. United States Access Board. *Draft Public Rights-of-Way Accessibility Guidelines (PROWAG)*. www.access-board.gov/prowac. Accessed March 2009.
23. *Guide for Development of Bicycle Facilities*. AASHTO, Washington, D.C., 1991.
24. *Guide to Traffic Engineering Practice, Part 6: Roundabouts*. Austroads, Sydney, Australia, 1993.
25. Service d'Études Techniques des Routes et Autoroutes (Sétra—Center for Technical Studies of Roads and Highways). *Aménagement des Carrefours Interurbains sur les Routes Principales (Design of Rural Intersections on Major Roads)*. Ministry of Transport and Housing, December 1998.
26. Standard No. MD 620.02-01, Standard Types C and D Concrete Curb and Combination Concrete Curb and Gutter. Maryland State Highway Administration. Revised 4-17-07.
27. King, S. E-mail to NCHRP Project 3-65a project team. November 20, 2009.
28. Wisconsin Department of Transportation. S.D.D 8D1-17, Concrete Curb, Concrete Curb & Gutter and Ties. Approved September 4, 2008.
29. McCulloch, H. E-mail to NCHRP Project 3-65a project manager. October 13, 2009.
30. American Concrete Paving Association. www.pavement.com.
31. Lee Engineering and Kittelson & Associates, Inc. *Roundabouts: An Arizona Case Study and Design Guideline*. Final Report 545. Arizona Department of Transportation, Phoenix, Arizona, July 2003.

CHAPTER 7
APPLICATION OF TRAFFIC CONTROL DEVICES**CONTENTS**

7.1 INTRODUCTION	7-4
7.2 PRINCIPLES	7-4
7.3 PAVEMENT MARKINGS	7-5
7.3.1 Approach and Departure Pavement Markings	7-5
7.3.2 Circulatory Roadway Pavement Markings	7-13
7.3.3 Mini-Roundabout Pavement Markings	7-16
7.4 SIGNING	7-17
7.4.1 Regulatory Signs	7-18
7.4.2 Warning Signs	7-21
7.4.3 Guide Signs	7-23
7.4.4 Supplemental Treatments	7-29
7.5 SIGNALIZATION	7-31
7.5.1 Metering	7-31
7.5.2 Pedestrian Signals at Roundabouts	7-33
7.5.3 Signal Mounting Location	7-37
7.5.4 Full Signalization of the Circulatory Roadway	7-38
7.6 AT-GRADE RAIL CROSSINGS	7-38
7.7 REFERENCES	7-42

LIST OF EXHIBITS

Exhibit 7-1 Approach and Departure Pavement Markings	7-6
Exhibit 7-2 Vane Island between Entry Lanes	7-7
Exhibit 7-3 Lane-Use Arrow Options for Roundabout Approaches	7-8
Exhibit 7-4 Yield Ahead Marking Placement	7-10
Exhibit 7-5 Roundabout Entrance Pavement Markings	7-11
Exhibit 7-6 Example of Staggered Yield Line on a Multilane Approach	7-11
Exhibit 7-7 Typical Crosswalk Markings on a Roundabout Approach	7-12
Exhibit 7-8 Circulatory Roadway Markings	7-13
Exhibit 7-9 Circulatory Roadway Lane Line Pattern Using Solid and Dotted Lines	7-15
Exhibit 7-10 Alternative Circulatory Roadway Lane Line Pattern Using a Uniform Dotted Line	7-15
Exhibit 7-11 Example Markings for a Mini-Roundabout	7-17
Exhibit 7-12 Roundabout Directional Arrow Signs (R6-4, R6-4a, and R6-4b)	7-18
Exhibit 7-13 One-Way Sign (R6-1R)	7-18
Exhibit 7-14 Roundabout Circulation Plaque (R6-5P)	7-19
Exhibit 7-15 Intersection Lane-Control Signing Options for a Roundabout Approach with Double Left-Turn Lanes	7-20
Exhibit 7-16 Intersection Lane-Control Sign Arrow Options for Roundabouts	7-20
Exhibit 7-17 Circular Intersection Sign (W2-6)	7-22
Exhibit 7-18 Example of Regulatory and Warning Signs for Mini-Roundabouts	7-24
Exhibit 7-19 Example of Regulatory and Warning Signs for Single-Lane Roundabouts	7-25
Exhibit 7-20 Example of Regulatory and Warning Signs for a Two-Lane Roundabout with Consecutive Double Left Turns ...	7-26
Exhibit 7-21 Exit Destination Signs with Text and Arrows	7-27
Exhibit 7-22 Diagrammatic Exit Destination Sign	7-27
Exhibit 7-23 Advance Street Name Sign for Use at Roundabouts (D3-2)	7-28
Exhibit 7-24 Exit Guide Signs	7-28
Exhibit 7-25 Example Sign Layout for Guide Signs at Roundabouts	7-29
Exhibit 7-26 Internally Illuminated Bollard	7-30
Exhibit 7-27 Examples of Speed Reduction Treatments	7-30
Exhibit 7-28 Example Diagram Showing Metering Signal Operation in Clearwater, Florida	7-32

Exhibit 7-29 Examples of Metering Signals 7-32

Exhibit 7-30 Pedestrian Signal Placement at Angled Crosswalk 7-34

Exhibit 7-31 Pedestrian Signal Placement at Staggered Crosswalk 7-35

Exhibit 7-32 Display Sequence for a Pedestrian Hybrid Beacon 7-36

Exhibit 7-33 Examples of Warning Beacons at Pedestrian Crossings 7-37

Exhibit 7-34 Rail Crossing One Leg of the Intersection 7-40

Exhibit 7-35 Rail Crossing through Center of Roundabout 7-41

Exhibit 7-36 Rail Running down Roadway Median 7-42

7.1 INTRODUCTION

This chapter presents guidelines on the application of traffic control devices associated with roundabouts. The design installation of these elements is an important component in achieving the desired operational and safety features of a roundabout.

The *Manual on Uniform Traffic Control Devices for Streets and Highways (1)*, the latest version of FHWA's *Standard Highway Signs*, and any applicable state and local standards govern the design and placement of traffic control devices, including signs, pavement markings, and signals. This chapter is intended to reflect the state of the practice for signing, marking, and use of other traffic control devices for roundabouts; however, the MUTCD and any relevant state and local policies supersede the guidance of this chapter in the event of a conflict.

A variety of photos are provided within this chapter to illustrate specific signs, markings, or other traffic control features. Inclusion of these photos does not constitute an endorsement of the geometric features captured, which are not the subject of the photo. Additionally, some photos may contain traffic control devices that reflect the practice of their time and may no longer reflect current practice.

7.2 PRINCIPLES

At roundabouts, pavement markings and signs work together to create a comprehensive system to guide and regulate road users. For signs and pavement markings at roundabouts to provide appropriate guidance, the following general principles should be considered:

- Markings and signs are integral to the design of roundabouts, especially for multilane roundabouts. Markings, in particular, need to be considered during the preliminary design stages, rather than fitting them in later in the design process.
- Markings and signs complement the geometric design of the roundabout. They clarify the rules of the road to the user, but they do not create the safety characteristics to the extent the geometric design does.
- Markings and signs should be compatible with each other to present a consistent message to the road user. Likewise, markings on approaches to the roundabout should be compatible with circulatory roadway markings.
- Markings and signs should facilitate through and turning movements in a manner such that drivers choose the appropriate lane when approaching a roundabout and then do not need to change lanes within the circulatory roadway before exiting in their desired direction.
- Approach markings should provide adequate time and distance for approaching drivers to select the appropriate lane for their desired exit.

These principles also extend to the designation of lanes on approaches to roundabouts:

- *Traffic volume considerations and roundabout operations.* Roundabouts should be designed with the appropriate number and assignment of lanes to handle the expected through, left-turning, and right-turning traffic. This may require more than one lane to handle the expected demand for some movements and may also require that some lanes be used for multiple movements (see Chapter 4).
- *Balanced lane use.* Lane use should be balanced as much as practical. In some situations, certain lane designations (or the lack thereof) may result in the overuse of some lanes for certain movements, resulting in unnecessarily long queues and congestion. This can also result in reduced safety as motorists try to bypass congestion by choosing inappropriate lanes for their desired movements. This is challenging when traffic patterns vary widely throughout the day.
- *Exit lane requirements.* The number of exit lanes provided should be the minimum required to handle the expected exit volume. However, drivers have a reasonable expectation that there will be an exit lane to receive each corresponding entry lane (e.g., two exit lanes to receive a double left turn).

7.3 PAVEMENT MARKINGS

Typical pavement markings for roundabouts delineate the entries, exits, and the circulatory roadway, providing guidance for pedestrians and vehicle operators. This section discusses the application of some of the more relevant pavement markings at roundabouts. Example pavement marking layouts for a variety of lane configurations are given in Appendix A.

7.3.1 APPROACH AND DEPARTURE PAVEMENT MARKINGS

Approach and departure pavement markings consist of lane lines, edge lines, lane-use arrows, other pavement word and symbol markings, yield lines, and crosswalk markings. Exhibit 7-1 shows typical approach and departure pavement markings. The following sections discuss these in more detail.

7.3.1.1 Centerlines and Edge Lines

Typically, yellow edge lines should be provided along splitter islands at the left edge of the approach and departure roadways and at the left edge of right-turn bypass roadways to enhance driver recognition of the changing roadway. Optionally, edge stripes may be omitted along splitter islands, allowing the islands themselves to provide edge delineation.

Double yellow centerline markings representing a two-direction no-passing zone should be used on undivided roadways on the approach to the splitter islands. Immediately before the splitter island the double yellow centerline markings should split into two double yellow markings, creating a taper to the raised splitter island. Yellow diagonal markings may be placed in the neutral area between the two sets of

Roundabouts: An Informational Guide

Exhibit 7-1
Approach and Departure
Pavement Markings

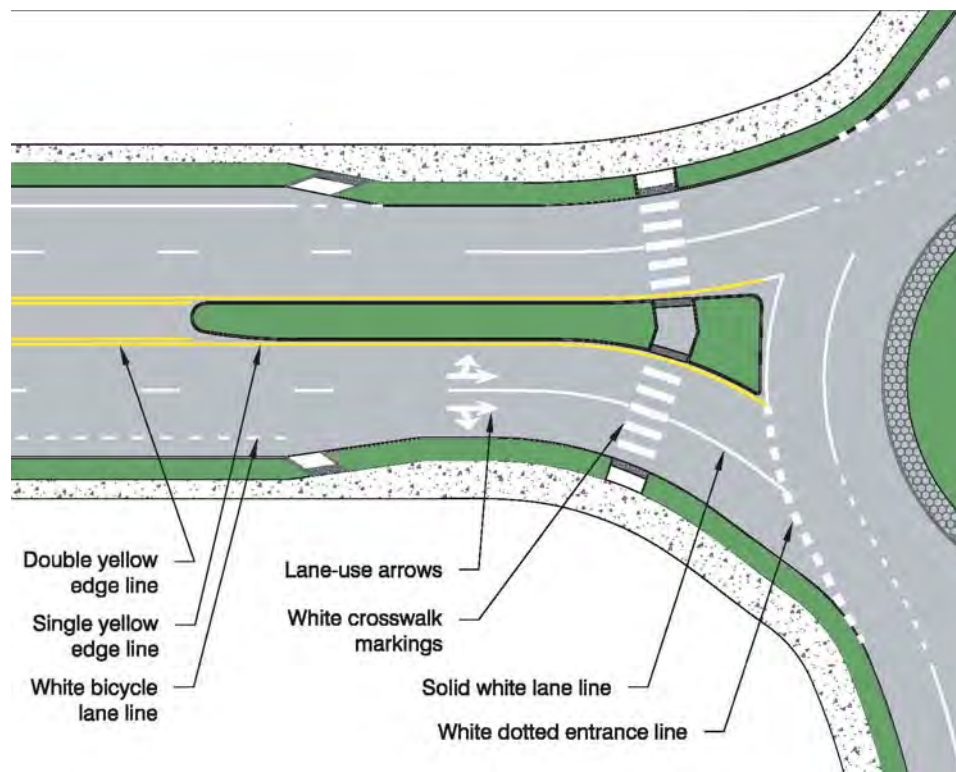

double yellow lines. For small splitter islands [area less than 75 ft² (7 m²)], the island may consist of pavement markings only, in the form of two sets of double yellow lines or marking the entire splitter island yellow. However, raised splitter islands should be used where possible.

White edge line markings may be used along the right side of the approach and departure roadways adjacent to the outside curb. White edge line markings should be used along the right side of approach and departure roadways adjacent to right-turn bypass islands to enhance driver recognition of the changing roadway.

Raised pavement markers may be used to supplement edge lines. These provide additional visibility at night and in inclement weather. However, they increase maintenance costs and can be troublesome in areas requiring frequent snow removal. In addition, raised pavement markers should not be used in the path of travel of bicyclists.

7.3.1.2 Lane Lines

As indicated in the MUTCD, white lane line markings should be used on multilane approaches. White lane lines should also be used on multilane departures. Solid white lane lines are recommended on roundabout approaches and departures to discourage lane changes in the immediate vicinity of the roundabout, as shown in Exhibit 7-1. Solid lane lines provide the following benefits:

- As at traditional signalized intersections, solid lane lines on approaches can improve safety by reducing the likelihood of sideswipe crashes caused by last-minute lane changes.

Solid white lane lines are recommended on roundabout approaches and departures.

- Solid lane lines on approaches and departures can discourage drivers from cutting across multiple lanes to attain a faster path through the roundabout. Using solid lane lines throughout the area of deflection can be used to provide this benefit.
- Solid lane lines can be used to discourage lane changes immediately before crosswalks to reduce the likelihood of multiple-threat crashes between vehicles and pedestrians.

On flared approaches to roundabouts, the lane lines in the flared section should extend back as far from the circulatory roadway as possible. For example, when flaring from one to two lanes, as soon as there is paved entry width of 20 ft (6 m) available, the lane line should begin, creating two 10-ft (3-m) approach lanes that will typically continue to widen approaching the circulatory roadway.

White channelizing lines are recommended on the approach to and departure from right-turn bypass islands, where traffic passes on both sides of the islands. Some agencies have used channelizing lines to create painted islands between entry lanes, sometimes called “vane islands.” These islands, shown in Exhibit 7-2, are believed to assist with deflecting entering vehicles to the appropriate position within the circulatory roadway while providing an overrun area for larger vehicles. White chevron markings may be placed in the neutral area between the channelizing lines.



Wisconsin

Exhibit 7-2
Vane Island between
Entry Lanes

7.3.1.3 Bicycle Lane Markings

Where bicycle lane markings are used on approach roadways, they should be terminated in advance of the circulatory roadway. See Chapter 6 for the geometric details for bicycle lanes on the approaches and departures of roundabouts, including taper rates.

On approaches to roundabouts, bicycle lane lines should be terminated as soon as the taper begins and at least 100 ft (30 m) from the edge of the circulatory roadway. The bicycle lane lines should be dotted for the last 50 to 200 ft (15 to 60 m) to

Bicycle lane markings should be terminated in advance of the circulatory roadway.

Roundabouts: An Informational Guide

give advance notice to cyclists that they need to merge, providing more room for them to achieve this maneuver and find an appropriate gap in traffic.

On roundabout departures, a dotted line should be used through the diverging taper, and the solid bike lane line should resume as soon as the normal bicycle lane width is available.

7.3.1.4 Lane-Use Arrows

Lane-use arrows are one of the major components of the comprehensive system of signing and marking at roundabouts. On roundabout approaches, lane-use arrows and intersection lane-control signs should complement each other and provide a consistent message to the traveling public. See Section 7.4.1.6 for a discussion of intersection lane-control signs.

Lane-use arrows are not necessary on single lane roundabouts. Lane-use arrows can be beneficial on the approaches to any multilane roundabout to assist drivers in selecting the appropriate lane before they enter the roundabout. On a typical two-lane roundabout, where the leftmost entry lane is for left turns and through movements and the rightmost entry lane is for right turns and through movements, approach lane-use arrows are generally not necessary. As roundabouts get more complex, lane-use arrows become increasingly important. Lane-use arrows should be used at roundabout approaches with double left-turn or double right-turn lanes and at other multilane roundabouts where lane-use arrows will improve lane utilization by drivers.

Standard lane-use arrows have been used at roundabouts internationally. In the United States, some concern has been raised by individual states regarding the legal interpretation of standard arrows at the entry to a roundabout with respect to whether it promotes turning left into the circulatory roadway. As described in the MUTCD, there are four different options for the design of lane-use arrows on the approach to roundabouts (shown in Exhibit 7-3). As shown on the left, normal lane-use arrows may be used with or without an oval symbolizing the central island. Alternatively, fishhook arrows, as shown on the right, may be used, with or without an oval symbolizing the central island. In choosing a lane-use arrow design, designers should consider the general practices within a city, region, or state. As a cautionary note, the more complex lane-use arrow designs may more

Exhibit 7-3
Lane-Use Arrow Options for
Roundabout Approaches

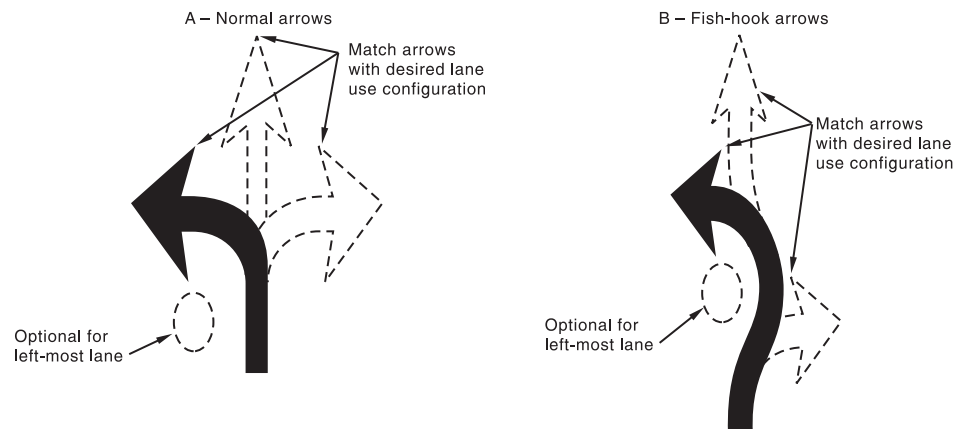

quickly lose their readability when a portion of the marking is worn away by the tires of passing vehicles.

Where lane-use arrows are used on roundabout approaches, it is important that left-turn arrows be included. Some practitioners have concerns that left-turn arrows on the approach will encourage drivers to make an improper left turn onto the circulatory roadway in front of the central island instead of making a proper left turn by circulating around the central island. This concern should not be allowed to override the need to provide appropriate lane-use arrows to encourage proper lane use at roundabouts, which in turn can reduce crashes at roundabout exits. There are several cues to the driver that they should not turn left onto the circulatory roadway, including the angle of approach to the circulatory roadway, the fact that circulating traffic is in an opposing direction, the signs on the central island that point the correct direction, and lane-use arrows on the circulatory roadway that point the correct direction. The fishhook arrows and the oval symbolizing the central island as shown in Exhibit 7-3 are intended to further mitigate the concern that drivers may mistake the left-turn arrow as directing them to turn left onto the circulatory roadway.

The MUTCD requires the use of lane-use arrows on an approach to a roundabout where a through lane becomes a left-turn only lane or a right-turn only lane.

Lane-use arrows (and corresponding lane-use signs) should be placed as far in advance of the roundabout as practical in order to give drivers plenty of time to select the correct approach lane for their desired exit. Lane-use arrows can be repeated to provide more emphasis and continue to encourage drivers to select the correct approach lane. The set of arrows closest to the roundabout should be provided upstream of the pedestrian crossing, with no arrows provided in the area between the pedestrian crossing and the entrance line.

At roundabouts with more than four legs, it can be difficult to select the appropriate lane-use arrows on the approaches. Engineering judgment should be used to choose the appropriate lane-use arrows for each lane. The angle between the entry leg and the possible exit legs should be a major factor in this decision. A good rule of thumb is to designate legs that are less than 150° from the entry leg as right-turn movements, legs that are 150° to 210° from the entry leg as through movements, and legs that are more than 210° from the entry leg as left-turn movements. Other factors to consider include route continuity (e.g., using a through arrow to connect roadways with the same street name), the volume of traffic moving from the approach leg to each exit leg, and the fact that it might be appropriate to designate two closely spaced exit legs as the same type of movement. For example, if there is a low volume exit at about 60° from the entry leg, and two high-volume exits at 150° and 210° from the entry leg, it might be desirable to designate the 150° leg as a right-turn movement. At some complex roundabouts with many legs, it can be desirable to use other traffic control devices in addition to lane-use arrows to designate the appropriate approach lanes, such as pavement word and symbol markings and advance guide signs indicating destinations for each lane.

7.3.1.5 Pavement Word and Symbol Markings

In some cases, the designer may want to consider pavement word or symbol markings to supplement the signing, lane-use arrows, and other markings. These markings should conform to the standards given in the appropriate sections of the

Lane-use arrows on roundabout approaches need to include left turn arrows to encourage proper lane use. There are at least four other cues to the driver that they should not turn left onto the circulatory roadway in front of the central island.

Pavement word markings are less effective in rainy or especially snowy climates.

Roundabouts: An Informational Guide

MUTCD (3B.20 and 3C.06). The following types of pavement word and symbol markings can be used at roundabouts:

- *ONLY word marking.* An ONLY word marking may be used to supplement lane-use arrows in lanes that are designated for a single movement.
- *Route numbers, destinations, street names, and cardinal directions.* Pavement markings showing route number destinations, street names, or cardinal directions (NORTH, SOUTH, EAST, or WEST) can be used to assist drivers in selecting the appropriate entry lane on roundabout approaches. These markings would typically be used to supplement lane-use arrows, lane-use signs, and guide signs at roundabouts. At complex roundabouts with many legs, these markings can be especially useful because it can be difficult to adequately communicate appropriate lane use with only lane-use arrows. Route numbers may be shown using numerals and letters (e.g., I-275, US 97, or HWY 22) or by using pavement markings that simulate Interstate, U.S., State, and other official highway route shield signs, but elongated for proper proportioning when viewed as a marking. Word pavement markings can also spell out destinations, street names, or cardinal directions using elongated letters or numerals.
- *Yield Ahead symbol or word marking.* The yield ahead triangle symbol or YIELD AHEAD word pavement markings are sometimes used on roundabout approaches to supplement a Yield Ahead sign, as illustrated in Exhibit 7-4. The yield ahead symbol marking has the advantage of being symbolic and is similar to markings used in other countries; however, this marking has not seen widespread use in the United States to date.
- *YIELD word marking.* A YIELD word pavement marking is sometimes used at a roundabout entrance to supplement the yield sign. This marking is suggested in situations where additional identification of the requirement to yield is desirable, especially where yielding violations have been frequently observed. If used, the YIELD word marking should be placed immediately ahead of the entrance line or the yield line, as illustrated in Exhibit 7-5.

Exhibit 7-4
Yield Ahead Marking
Placement

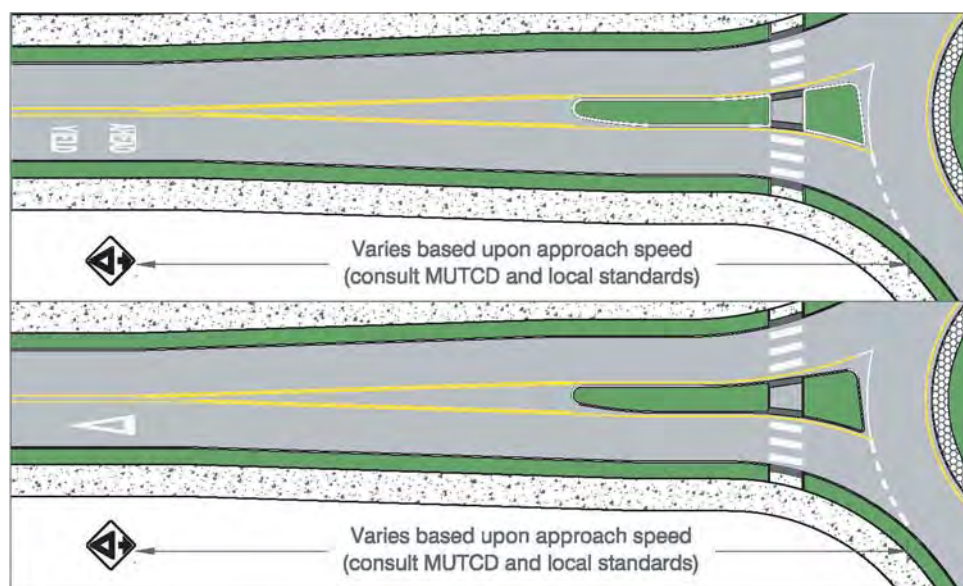

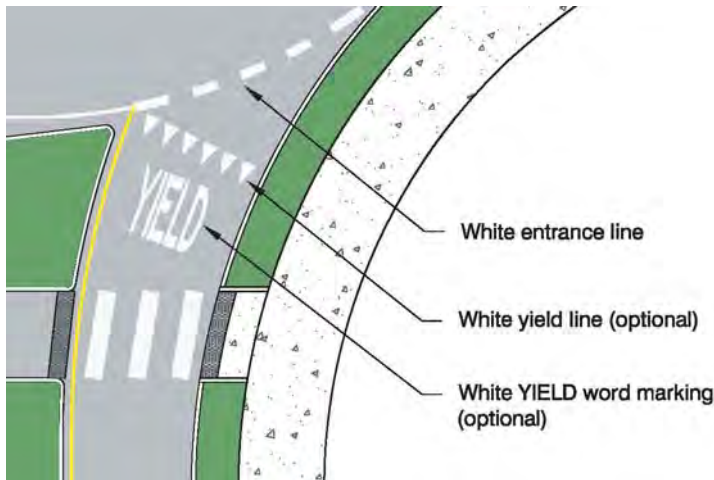

Exhibit 7-5
Roundabout Entrance
Pavement Markings

7.3.1.6 Entrance and Yield Lines

Dotted circulatory roadway edge line extensions should be used across the entry lanes of roundabouts, as illustrated in Exhibit 7-5. These edge lines act as entrance lines, marking the boundary between entering and circulating vehicles. The typical marking pattern for these lines can be found in Section 7.3.2.1.

Yield lines may be used in addition to entrance lines to further indicate the point behind which vehicles are required to yield in response to the yield signs. As described in MUTCD Section 3B.16, yield lines consist of a row of solid white isosceles triangles pointing toward approaching vehicles. Like other applications of yield lines and stop lines, the yield lines at roundabouts should normally be placed at right angles to the roadway. If used at multilane roundabouts, yield lines should be staggered on a lane-by-lane basis. Staggered yield lines are important at roundabouts so that drivers waiting at the yield line in the right-most lane(s) can more easily see past vehicles waiting in lanes to their left (see Exhibit 7-6).

Yield lines can be used to indicate where approaching vehicles should yield, supplementing the entrance lines.

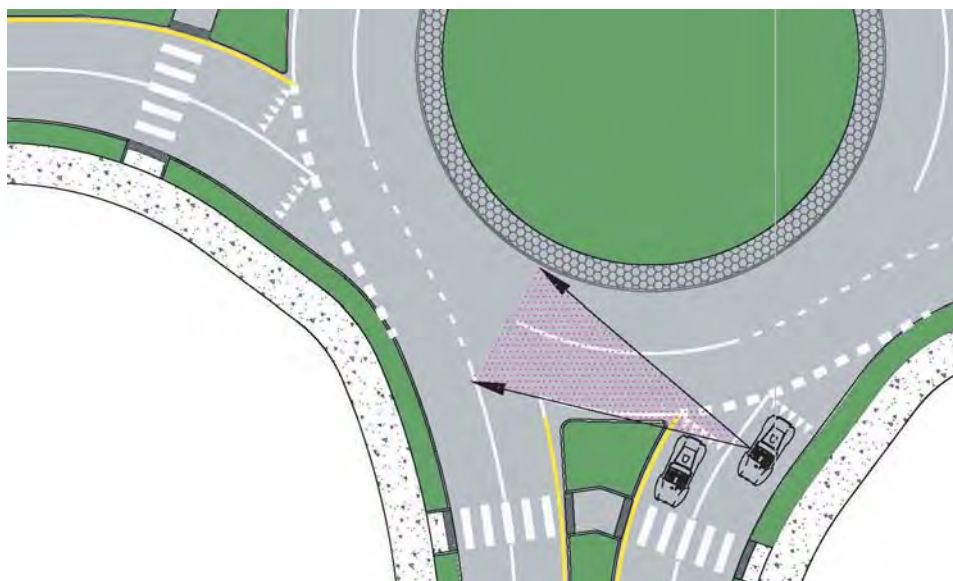

Exhibit 7-6
Example of Staggered Yield
Line on a Multilane Approach

7.3.1.7 Pedestrian Crosswalk Markings

Pedestrian crosswalk markings should be installed at all pedestrian crossing locations at roundabouts in urban and suburban locations. Crosswalk markings provide guidance for pedestrians in navigating a roundabout and provide a visual cue to drivers of where pedestrians may be within the roadway. The use of crosswalk markings in this manner is consistent with the MUTCD.

As discussed in Chapter 2, without crosswalk markings, the legal status of pedestrian crossings at roundabouts may be unclear, depending on state laws. For this reason, it is important that pedestrian crossings at roundabouts be marked to legally establish the crosswalk. Where the pedestrian crossing location is distinguished from the roadway by visually contrasting pavement colors and textures, crosswalk markings are still needed to legally establish the crosswalk. In this situation, the colored or textured area should be outlined with simple transverse crosswalk markings.

At roundabouts, crosswalk markings that are longitudinal to the flow of traffic (known as “Zebra” or “Continental” crosswalk markings) are recommended. Details on the dimensions of these markings can be found in MUTCD Section 3B.18. Longitudinal crosswalk markings, illustrated in Exhibit 7-7, have a number of advantages over transverse crosswalk marking in roundabout applications:

- The longitudinal markings provide a higher degree of visibility, which is important because the crosswalk is set back from the yield line.
- Longitudinal crosswalk lines are less likely to be confused with the entrance line or the yield line.
- Although the initial cost is somewhat higher, longitudinal markings require less maintenance if properly spaced to avoid the wheel paths of vehicles.

Crosswalk markings should be installed across the entrance and exit of each leg and across any right-turn bypass lanes. The crosswalk should be approximately perpendicular to the flow of vehicular traffic and be aligned with the ramps and pedestrian refuge in the splitter island. Additional geometric design details for pedestrian crossings at roundabouts can be found in Section 6.8.

Crosswalks should be marked to provide an important visual cue for drivers and pedestrians and to legally establish the location of the crosswalk set back somewhat from the intersection.

Longitudinal crosswalk markings (also known as “Zebra” or “Continental” markings) are recommended for use at roundabouts.

See Section 6.8 for additional details regarding the design of pedestrian crossings at roundabouts.

Exhibit 7-7
Typical Crosswalk Markings on a Roundabout Approach

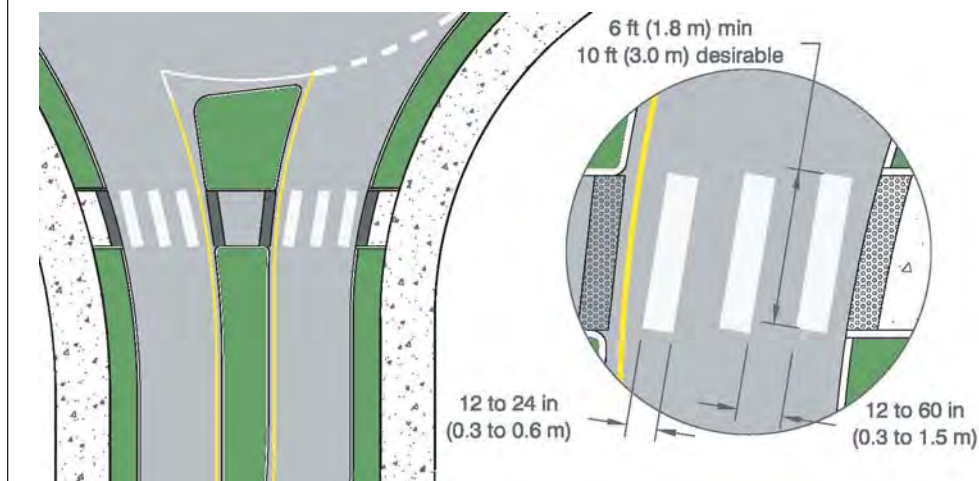

7.3.2 CIRCULATORY ROADWAY PAVEMENT MARKINGS

Circulatory roadway pavement markings consist of lane lines, edge lines, and lane-use arrows. Examples of these markings are shown in Exhibit 7-8, and the following sections discuss each of these types of markings in more detail.

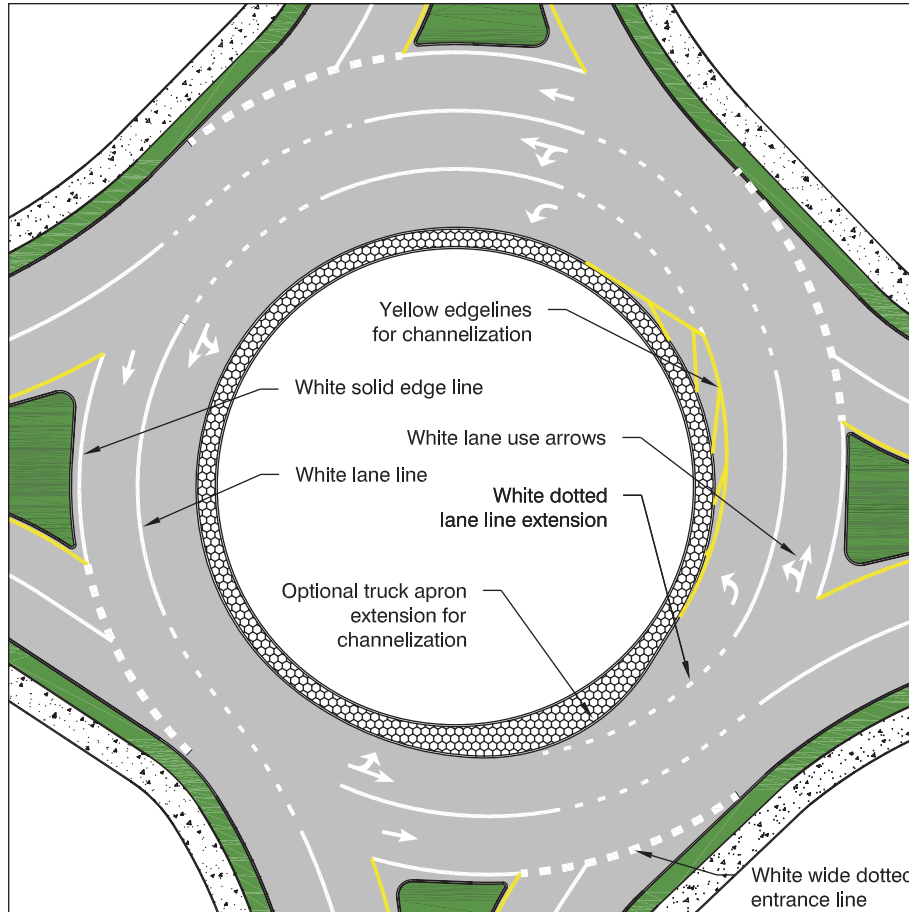

Circulatory roadway pavement markings are part of the comprehensive system of signing and marking for roundabouts.

Exhibit 7-8
Circulatory Roadway
Markings

7.3.2.1 Edge Lines

A yellow edge line may be placed around the inside edge of the circulatory roadway along the central island or truck apron. This line should have a width of 4 to 6 in. (100 to 150 mm). Yellow edge lines may also be used to channelize traffic away from the central island toward a specific circulating lane. This channelization is sometimes necessary to work in concert with lane line markings (see Section 7.3.2.2) to channelize traffic to the appropriate exit lane. Yellow diagonal markings may be placed in the neutral area between this channelizing edge line and the circulatory roadway. See Exhibit 7-8 for examples of the yellow edge lines described above. The exhibit also illustrates an alternative of extending the truck apron to provide raised channelization. At mini-roundabouts or other roundabouts with fully mountable central islands, the entire central island may be colored yellow in lieu of the yellow edge lines.

As described in MUTCD Section 3C.03, white edge line markings should be used on the outer edge of the circulatory roadway of roundabouts. Along the splitter

The white dotted edge line extension across the entry lane of a roundabout acts as an entrance line, delineating the circulatory roadway and reducing the need for yield line markings.

island, a normal-width white line should be used. Wide dotted edge line extensions should be placed across the entry lanes of roundabouts. These edge line extensions are typically 12- to 18-in. (300- to 450-mm) wide and have a typical marking pattern of 2-ft (0.6 m) lines with 2- to 3-ft (0.6 to 0.9 m) gaps. These edge lines guide circulating traffic around the roundabout and serve as an entrance line that marks the boundary separating entering and circulating traffic (see Section 7.3.1.6). The MUTCD prohibits the use of edge line extensions across the exit lanes.

7.3.2.2 Lane Lines

The marking of lane lines within the circulatory roadway of a roundabout is a topic that continues to receive debate within the United States. Lane lines within the circulatory roadway provide guidance to drivers when done properly, and their use is endorsed by many countries around the world. There is some concern regarding whether lane lines introduce challenges with trucks straddling lanes; further research on this topic is anticipated.

The 2009 MUTCD introduced new guidance under Section 3C.02 that multi-lane roundabouts should have lane line markings within the circulatory roadway to channelize traffic to the appropriate exit lane. These circulatory roadway lane line markings and lane-use arrows (see Section 7.3.2.3) should be designed to work together with approach lane line markings (see Section 7.3.1.2) and approach lane-use arrows (see Section 7.3.1.4) to ensure that once drivers have chosen the appropriate entry lane on the approach, they do not have to change lanes within the roundabout to use their desired exit. Lane lines are typically described in the MUTCD as “normal” lines, meaning that they should be 4- to 6-in. (100- to 150-mm) wide.

The MUTCD prohibits the use of continuous concentric lane lines within the circulatory roadway of roundabouts, unlike in continental Europe where the practice has been prevalent. Instead, lane lines should be designed to guide drivers along the roundabout circulatory roadway and toward the appropriate exit without requiring a lane change. This manages much of the problems associated with the exit–circulating conflict caused by lane changes to exit.

There are several possibilities for the marking pattern of lane lines within the circulatory roadway of roundabouts. Chapter 3C of the MUTCD does not discuss lane line marking patterns. However, the MUTCD figures show circulatory roadway lane lines as solid lines in front of the splitter island and dotted lines across the entry lanes, as illustrated in Exhibit 7-9. As stated in the MUTCD, the function of solid lines is to discourage or prohibit crossing, and the function of a dotted line is to provide guidance (as with a lane line extension through an intersection). The dilemma with circulatory roadway lane line marking patterns stems from the following facts:

- From the perspective of circulating traffic, a continuous solid line would be best to discourage lane changing within the circulatory roadway. This would appropriately support the principle of design to allow a driver to choose the appropriate lane on the approach and not need to change lanes to get to the desired exit.
- From the perspective of traffic entering a roundabout in any lane but the rightmost entry lane, a solid lane line across the roundabout entrance on

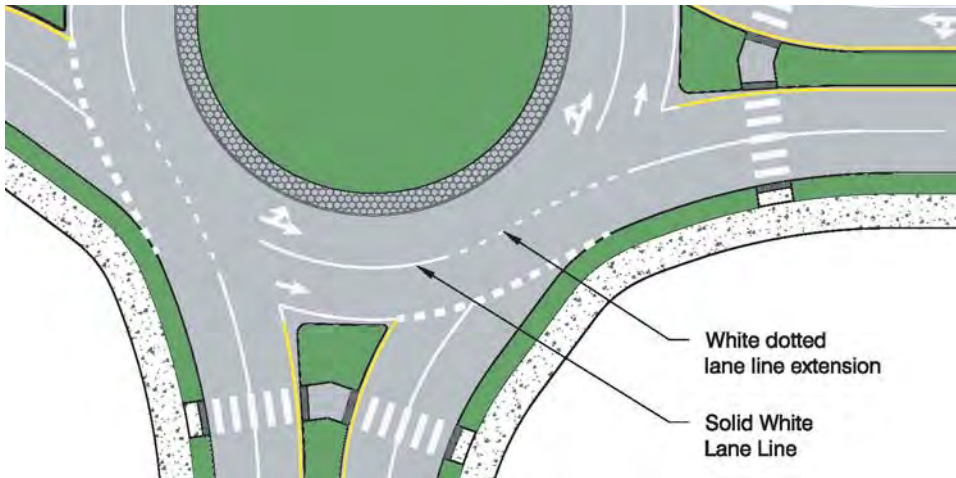

Exhibit 7-9
Circulatory Roadway Lane Line Pattern Using Solid and Dotted Lines

the circulatory roadway would discourage drivers from crossing the lane line to enter the appropriate lane, so it is useful to have a dotted line across the approach.

Some practitioners have raised concerns that if a solid line transitions to a dotted line at the approach as shown in the figures in Chapter 3C of the MUTCD and illustrated in Exhibit 7-9, circulating drivers might think that they are allowed to change lanes at the dotted line prior to exiting the roundabout. This unintended behavior could result in an increase in exit crashes.

Exhibit 7-10 illustrates an alternative marking pattern that has been used by some agencies within the United States. This strategy uses a uniform line pattern throughout the circulatory roadway and exits. The rationale for this pattern is that it is believed to be less likely to concentrate lane changes at the vulnerable entry–exit conflict area, and it is a line marking pattern that has been successfully employed in other countries. Common dimensions used for this type of marking consist of 6-ft (1.8-m) line segments and 3-ft (0.9-m) gaps. The reader should be aware that the 2009 MUTCD has introduced more specific definitions for line types in Section 3A.06, and the dimensions for the pattern shown in Exhibit 7-10 are not included within the allowed line types.

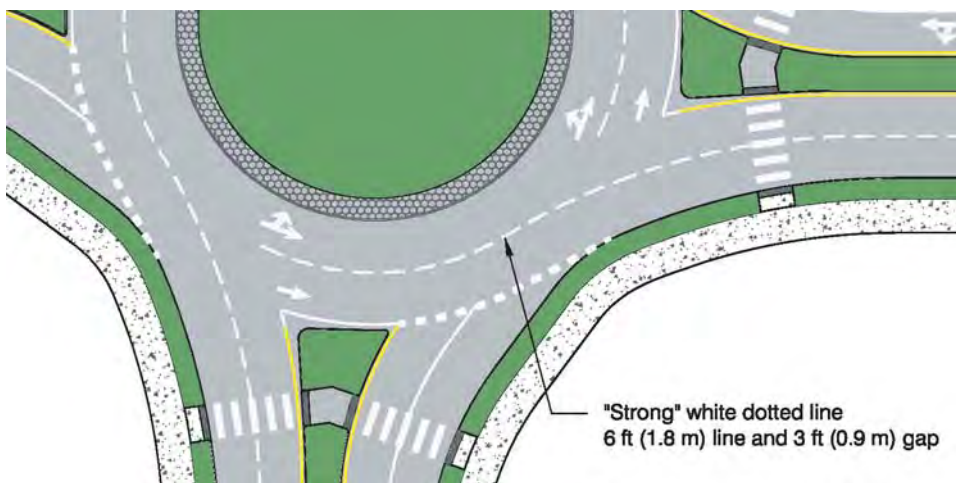

Exhibit 7-10
Alternative Circulatory Roadway Lane Line Pattern Using a Uniform Dotted Line

7.3.2.3 Lane-Use Arrows

Lane-use arrows within the circulatory roadway are an important component of the comprehensive system of signing and marking at roundabouts. These arrows provide confirmation to drivers, giving them confidence that they have entered in the correct lane and can continue circulating within this lane to get to their desired exit.

When used within the circulatory roadway of roundabouts, normal lane-use arrows should be used, without a fishhook design and without an oval symbolizing the central island. Lane-use arrows are typically placed in the area in front of the splitter island, where the circulatory roadway lane line begins (see the additional example exhibits in Appendix A). Arrows placed at this location are often visible to drivers as they approach the circulatory roadway, providing confirmation of lane choice as drivers enter the roundabout.

7.3.2.4 Bicycle Markings

The MUTCD prohibits the use of marked bicycle lanes within the circulatory roadway. As described in more detail in Section 6.8, bicycle lanes should be terminated upstream of the roundabout entrance.

The MUTCD prohibits bike lane markings on the circulatory roadway.

7.3.3 MINI-ROUNDBABOUT PAVEMENT MARKINGS

At mini-roundabouts, some pavement marking treatments are different from those at other urban roundabouts. The following pavement marking treatments are recommended for mini-roundabouts:

- *Lane-use arrows.* Lane-use arrows should be provided in the circulatory roadway adjacent to each splitter island to indicate the direction of circulation. No signs can be placed in the fully mountable central island, although the roundabout circulation plaque should be installed under the yield sign to legally establish the circulation direction within the roundabout, as described in Section 7.4.1.4. Lane-use arrows provide an additional indication of the circulation direction
- *Yellow edge lines.* Yellow edge lines are sometimes used along the left side of the approach roadway and circulatory roadway to delineate the mountable central island and splitter islands. Alternatively, the entire mountable central island and splitter islands are sometimes painted yellow to improve their visibility. The splitter island may instead be delineated only by two sets of double yellow lines, rather than being a raised island. Trade-offs with this approach are discussed in Section 6.6.
- *White edge lines.* As described in Section 7.3.2.1, wide dotted edge line extensions (entrance lines) should be placed across the entry lanes of mini-roundabouts. Section 6.6 includes some important information about entrance line placement at mini-roundabouts. In addition, a solid white edge line may be used along the splitter island; if splitter islands are delineated only by two sets of double yellow lines, then this white edge line is recommended.
- *Yield lines.* Yield lines may be used to indicate the point behind which vehicles are required to yield at the entrance to a mini-roundabout, as

described in Section 7.3.1.6. However, most mini-roundabouts are simple enough that entrance lines are sufficient for this purpose.

- *Crosswalk markings.* As described in Section 7.3.1.7, crosswalk markings should be installed at mini-roundabouts, as with other roundabouts where pedestrian sidewalks and ramps are provided.

Exhibit 7-11 illustrates a sample mini-roundabout pavement marking plan.

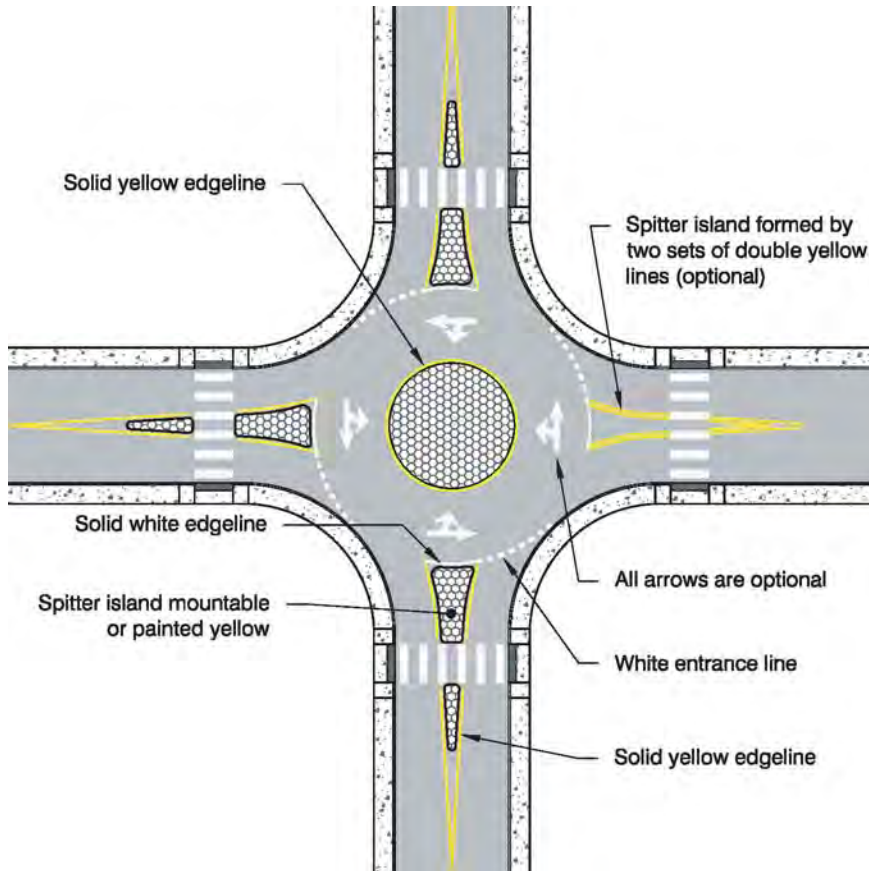

Exhibit 7-11
Example Markings for a
Mini-Roundabout

7.4 SIGNING

The overall concept for signing of roundabouts is similar to signing of general intersections. Proper regulatory control, advance warning, and directional guidance enhance and support driver expectations. Signs should be located where they have maximum visibility for road users but a minimal likelihood of even momentarily obscuring vulnerable users, including pedestrians, motorcyclists, and bicyclists. Signing needs are different for urban and rural applications and for different categories of roundabouts.

Only signs unique to roundabouts are shown here graphically. The reader is encouraged to refer to the MUTCD for details on other signs. The MUTCD provides options for enhancing sign conspicuity in Section 2A.15.

Roundabouts: An Informational Guide

7.4.1 REGULATORY SIGNS

A number of regulatory signs are appropriate for roundabouts and are described below.

7.4.1.1 Yield Sign

A yield sign (R1-2) is required on the right side of each entry into the roundabout. A second yield sign on the left side of the approach (mounted on the splitter island) provides additional visibility and is particularly recommended for approaches with more than one lane.

7.4.1.2 Roundabout Directional Arrow Signs

The roundabout directional arrow signs (R6-4, R6-4a, and R6-4b), shown in Exhibit 7-12, are new signs included in the 2009 MUTCD. These signs are the preferred method of indicating the direction of travel within the circulatory roadway. The black-on-white chevron design provides a regulatory message, legally establishing the direction of circulation at roundabouts. These replace the black-on-yellow chevron warning signs used previously, which are intended for use on horizontal curves. These signs should be placed on the central island opposite the roundabout entrances to direct traffic counterclockwise around the central island. On multilane approaches, high-speed approaches, approaches with limited visibility, or in other circumstances where increased sign visibility is desirable, the larger R6-4a or R6-4b signs are appropriate. For even more visibility, multiple roundabout directional arrow signs may be used. The MUTCD allows a reduced minimum mounting height of at least 4 ft for the roundabout directional arrow signs.

Yield signs are required on all approaches.

Roundabout directional arrow signs establish the direction of traffic flow within the roundabout.

Exhibit 7-12
Roundabout Directional Arrow Signs (R6-4, R6-4a, and R6-4b)



7.4.1.3 One-Way Sign

One-Way signs (R6-1R) may be used instead of or in addition to the roundabout directional arrow signs (see Section 7.4.1.2) in the central island opposite the entrances to direct traffic counterclockwise around the central island. These are required in some states where the circulatory roadway of the roundabout is legally defined as a one-way roadway (rather than being the interior of an intersection). The R6-1R sign shown in Exhibit 7-13 is recommended for use at roundabouts, not the R6-2 version of the one-way sign.

One-Way signs can be used in addition to or instead of the roundabout directional arrow sign to establish the direction of traffic flow within the roundabout.

Exhibit 7-13
One-Way Sign (R6-1R)



Roundabout Directional Arrow signs are preferred over One-Way signs for several reasons:

- The black-and-white chevron design of the Roundabout Directional Arrow signs is unique and can only be used at roundabouts. Therefore, consistent and uniform use of this sign will serve to remind road users when they are entering a roundabout.
- The use of One-Way signs at roundabouts could result in some road users incorrectly concluding that the cross street is a one-way street. One-Way signs may be especially confusing at an intersection where the cross street is actually a one-way street traveling from right to left from the perspective of an approaching driver.

In some states, the vehicle code or other statutes define a roundabout as a series of T-intersections. In these areas, One-Way signs may be necessary to legally establish the direction of travel within the circulatory roadway. These One-Way signs may be supplemented with roundabout directional arrow signs as unique signs that help identify roundabouts.

The black-on-yellow One-Direction Large-Arrow warning sign should not be used at roundabouts.

7.4.1.4 Roundabout Circulation Plaque

At mini-roundabouts, the Roundabout Directional Arrow signs or One-Way signs cannot be placed within the central island due to the island being fully mountable. In these situations, the MUTCD provides a Roundabout Circulation (R6-5P) plaque, as shown in Exhibit 7-14. This sign is placed below each yield sign on each approach to the roundabout to define the direction of circulation within the roundabout. This is a new sign that was created specifically for this purpose and included in the 2009 MUTCD.



Exhibit 7-14
Roundabout Circulation
Plaque (R6-5P)

The Roundabout Circulation plaque may also be placed below the yield signs on approaches to roundabouts to supplement the Roundabout Directional Arrow signs or one-way signs.

7.4.1.5 Keep Right Sign

Keep Right signs (R4-7 or text variations R4-7a and R4-7b) are commonly used at the nose of non-mountable splitter islands. For small splitter islands, a narrow Keep Right sign (R4-7c) or an object marker are sometimes used as a substitute. This may reduce sign clutter and improve the visibility of the yield sign and other signs on a roundabout approach. The use of internally illuminated bollards is discussed in Section 7.4.4.

Roundabouts: An Informational Guide

Intersection lane-control signs can be beneficial at multilane roundabouts, especially those with double turn lanes.

7.4.1.6 Intersection Lane-Control Signs

For roundabouts with multiple entry lanes, as for any intersections with multiple entry lanes, drivers benefit from a consistent system of signing and marking telling them which lanes to use for the various left, through, and right movements. This is particularly important if the lane configuration is not consistent with the default rules of the road: left turns allowed only from the leftmost lane, right turns allowed only from the rightmost lane, and through movements allowed from any lane. Intersection lane-control signs may be used on multilane roundabout approaches (R3-5 through R3-8) to complement the lane-use arrows and other pavement markings and provide a consistent message to the traveling public. Advance intersection lane-control signs (R3-8 series) are preferred at roundabouts, although there may be occasions where other lane-control signs may be appropriate.

Intersection lane-control signs are not necessary on single-lane approaches or at a typical two-lane roundabout, where the leftmost entry lane is for left turns and through movements and the rightmost entry lane is for right turns and through movements. At more complex roundabouts, intersection lane-control signs are more important. Intersection lane-control signs should be used at roundabout approaches with double left-turn or double right-turn lanes and at other multilane roundabouts where the signs used in conjunction with lane-use arrows will improve lane utilization by drivers.

The MUTCD includes several options for arrow symbols on intersection lane-control signs, as shown in Exhibit 7-15 and Exhibit 7-16. The fishhook arrows and the circle symbolizing the central island shown in this exhibit have been proposed by some agencies to provide additional clarification to drivers that they must circulate around the central island when traveling along the circulatory roadway.

Lane-control signs should be provided as far in advance of the intersection as practical to allow time for drivers to select the appropriate lane for their maneuver prior to entering the roundabout. Exhibit 7-20 illustrates an example placement

Exhibit 7-15
Intersection Lane-Control Signing Options for a Roundabout Approach with Double Left-Turn Lanes

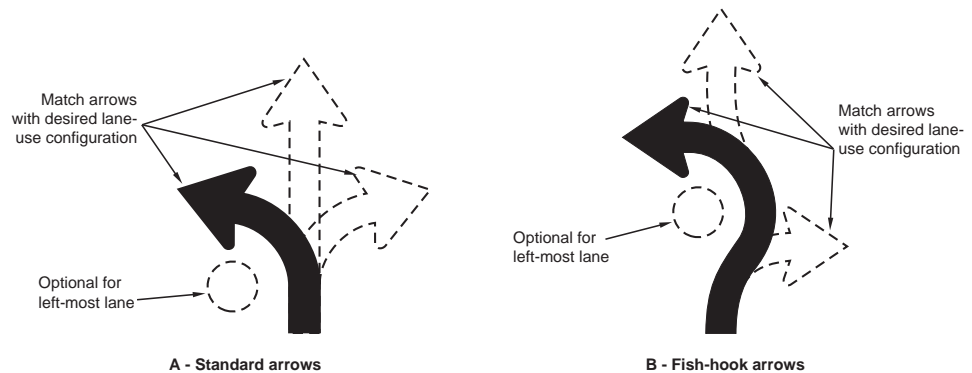
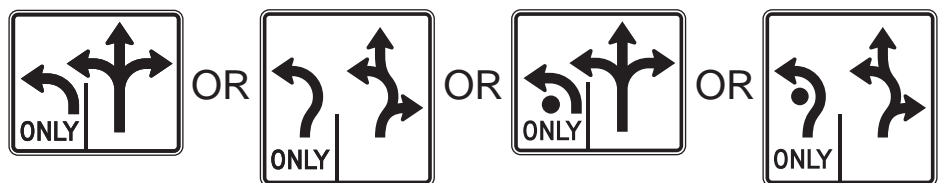

Exhibit 7-16
Intersection Lane-Control Sign Arrow Options for Roundabouts



of the lane-control signs adjacent to the corresponding lane-use arrow markings. An optional second set of lane designation signing (not shown in Exhibit 7-20) may also be provided upstream of the pedestrian crossing, adjacent to the second set of lane-use arrow markings. The redundant lane-use signing may help to reinforce the lane-use messages to drivers, particularly for more complex lane configurations. Any additional signs should be balanced against the concern for creating sign clutter.

The MUTCD does not specifically address the use of overhead lane-control signs at roundabouts. It does recommend overhead lane-control signs at signalized intersections with lane drops, multiple-lane turns, or other unexpected lane-use regulations. At roundabouts, overhead lane-use control signs, if used, are likely most effective upstream of a roundabout and not at or near the entry due to the need for driver attention to other users at crosswalks and the entry.

7.4.1.7 Other Regulatory Signs

- *Yield Here to Pedestrians and Stop Here for Pedestrians signs.* These R1-5 series signs, used in conjunction with yield lines or stop lines in advance of mid-block crosswalks, have been shown to reduce the potential for multiple-threat crashes. However, at roundabouts, the installation of a yield line or stop line could be confusing for motorists, and these signs can potentially add to sign clutter on roundabout approaches. Therefore, as stated in the MUTCD, these signs should not be used in advance of crosswalks that cross an approach to or departure from a roundabout. There may be some exceptions to this recommendation, for example, where the crosswalk is much further than usual from the edge of the circulatory roadway.
- *No-Left-Turn and No-U-Turn signs.* The MUTCD prohibits the use of the No-Left-Turn (R3-2) sign, the No-U-Turn (R3-4) sign, and the combination No-U-Turn/No-Left-Turn (R3-18) sign at roundabout entries as a means to prohibit drivers from turning left onto the circulatory roadway of a roundabout in front of the central island. The roundabout directional arrow signs provide clear guidance to drivers upon entry as to the correct direction of travel to navigate the roundabout. Section 7.3.1.4 describes many other cues to drivers that they should not turn left onto the circulatory roadway. In addition, lane-use arrow pavement markings (see Section 7.3.1.4) and intersection lane-control signs (see Section 7.4.1.6) include arrow-symbol options with fishhook arrows and an oval or circle symbolizing the central island, which are intended to further discourage drivers from inadvertently turning left onto the circulatory roadway in front of the central island.

7.4.2 WARNING SIGNS

A number of warning signs are appropriate for roundabouts and are described below. The amount of warning a motorist needs is related to the intersection setting and the vehicular speeds on approach roadways. The specific placement of warning signs is governed by the applicable sections of the MUTCD.

7.4.2.1 Circular Intersection Sign

A Circular Intersection sign (W2-6), shown in Exhibit 7-17, should be installed on each approach in advance of the roundabout, particularly if the roundabout is not clearly visible on the approach. The purpose of this sign is to convey to road

Roundabouts: An Informational Guide

Exhibit 7-17
Circular Intersection
Sign (W2-6)



users that they are approaching an intersection with the form of a roundabout. This sign, introduced in the 2003 edition of the MUTCD, has many advantages over advance warning signs that have been used at roundabouts in the past:

- It includes an easily recognizable symbol that is similar to the symbols used for roundabouts in other countries.
- It gives advance notice of the proper direction of circulation within the roundabout.
- It can be used universally for roundabouts with any number of legs.

This sign is sometimes supplemented with an educational plaque with the legend “ROUNDABOUT” (W16-17P) or with an advance street name plaque (W16-8 or W16-8a).

Advisory speed plaques have been used in the past as a supplement to the Circular Intersection sign but are no longer recommended for roundabouts in the MUTCD. In practice it is difficult to define an appropriate advisory speed: Should it be related to the slowest speed for through traffic (V₂), the slowest speed of all movements (typically V₄), or another speed (such as zero for potentially coming to a stop at the yield sign)? In addition, advisory speed plaques are usually only used for turns and curves, not intersections.

7.4.2.2 Pedestrian Crossing Sign

Pedestrian Crossing signs (W11-2) may be used at pedestrian crossings at both entries and exits of roundabouts, supplemented with a diagonal downward pointing arrow plaque (W16-7P) showing the location of the crossing. Pedestrian Crossing signs should be used at all pedestrian crossings at multilane entries, multilane exits, and right-turn bypass lanes. Where installed, Pedestrian Crossing signs should be located in such a way to not obstruct the view of the yield sign.

7.4.2.3 Object Markers

Object markers may be used at the nose of all non-mountable splitter islands in addition to or in lieu of Keep Right signs. Object markers are smaller and can be mounted at a lower mounting height than Keep Right signs. Using object markers instead of Keep Right signs may reduce sign clutter and improve the visibility of the yield sign and other signs on a roundabout approach. Type 1 and Type 3 Object Markers are both appropriate for splitter islands. Type 3 Object Markers are only 12 in. wide and can be placed on narrow splitter islands.

7.4.2.4 Other Warning Signs

- *Yield Ahead sign.* The Yield Ahead sign (W3-2) has been used previously at some roundabouts to provide advance notice to drivers of the yield sign at the roundabout entrance. It is still permissible to use this sign on a roundabout approach. However, due to the large number of other signs on roundabout approaches, it is recommended that this sign be used only in special circumstances. For example, at rural roundabouts where there are no pedestrian facilities and therefore no pedestrian warning signs, this sign could be placed downstream of the Circular Intersection sign (see Section 7.4.2.1). As drivers become more familiar with roundabouts, there will be an increasing awareness that a yield sign is to be expected whenever they see the Circular Intersection sign, roundabout-specific guide signs, and many of the other signs and markings that are unique to roundabouts, further reducing any need for Yield Ahead signs at roundabouts.
- *Advance Pedestrian Crossing sign.* In most cases where crosswalks are marked and Pedestrian Crossing signs (W11-2) are used at a crosswalk, designers also include a Pedestrian Crossing sign in advance of the crosswalk. However, on the approach and departure of roundabouts, using these advance signs would result in additional signs in an area where many other important signs need to be installed. Therefore, in most cases, advance Pedestrian Crossing signs are not recommended at roundabouts. Pedestrian Crossing signs at the crosswalk itself are more critical and may be used as described in Section 7.4.2.2.

The Yield Ahead sign is only needed in special circumstances where the yield sign is not visible.

7.4.2.5 Example Sign Layouts for Regulatory and Warning Signs

Exhibit 7-18, Exhibit 7-19, and Exhibit 7-20 illustrate examples of regulatory and warning sign layouts for mini-roundabouts, single-lane roundabouts, and multilane roundabouts, respectively. Guide sign layouts are presented later in Section 7.4.3.

7.4.3 GUIDE SIGNS

Guide signs are important in providing drivers with proper navigational information. This is especially true at roundabouts where out-of-direction travel may disorient unfamiliar drivers. A number of guide signs are appropriate for roundabouts and are described below.

7.4.3.1 Advance Signs

Advance-destination guide signs should be used in all rural locations and in urban/suburban areas where appropriate. There are several types of guide signs that can be used in advance of roundabouts as described in the bullets below. These types include signs using just text and arrows as well as diagrammatic signs. On larger roads and in suburban or rural areas where space is available, diagrammatic signs are preferred because they reinforce the form and shape of the approaching intersection and make it clear to the driver how they are expected to navigate the intersection.

Diagrammatic signs can be especially useful where the geometry of the roundabout is not typical, such as where more than four legs are present or where the legs are not at 90° angles to each other. Advance-destination guide signs are

The circular shape in a diagrammatic sign provides an important visual cue to all users of the roundabout.

Roundabouts: An Informational Guide

Exhibit 7-18
Example of Regulatory
and Warning Signs for
Mini-Roundabouts

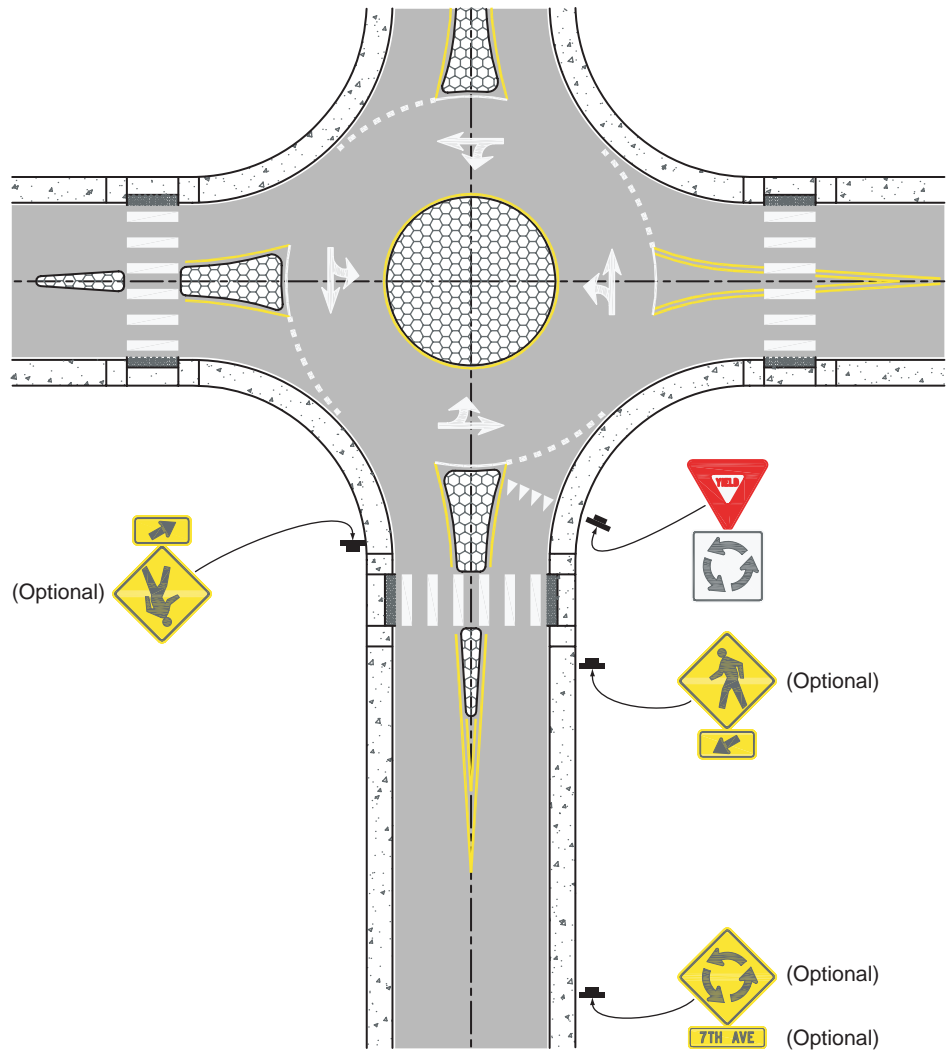

Source: 2009 MUTCD (1)

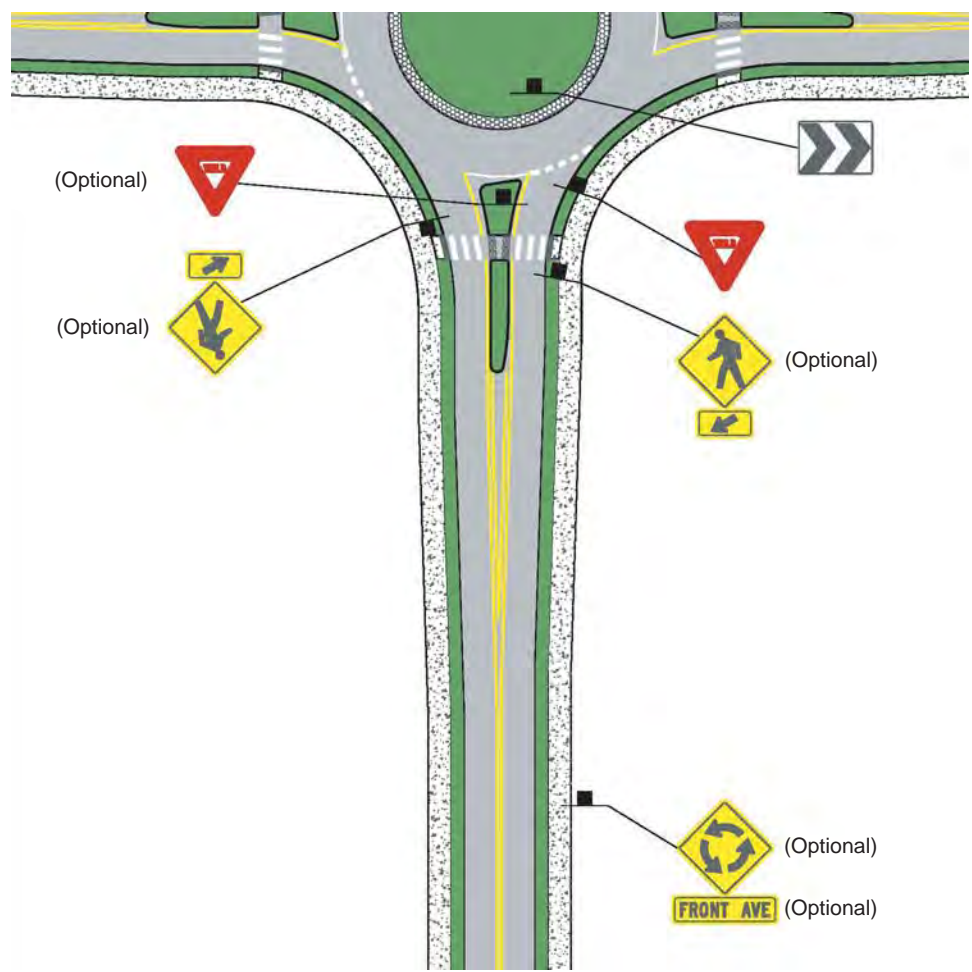

Exhibit 7-19
Example of Regulatory and
Warning Signs for Single-
Lane Roundabouts

Source: 2009 MUTCD (1)

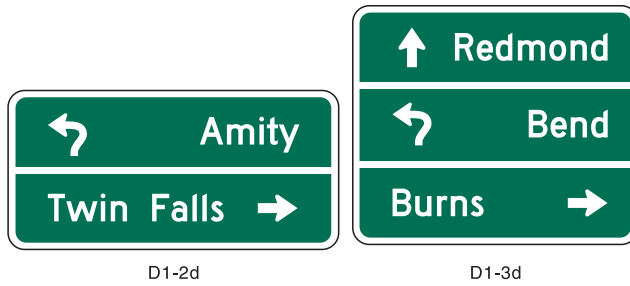
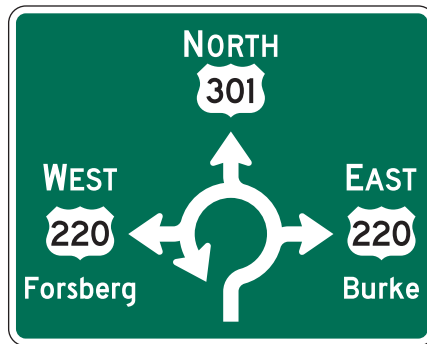

Exhibit 7-21
Exit Destination Signs with Text and Arrows



D1-5



D1-5a

Exhibit 7-22
Diagrammatic Exit Destination Sign

Advance Street Name (D3-2) signs are sometimes installed in advance of roundabouts to provide road users with the name(s) of the next intersecting street (Exhibit 7-23). These are comparable to the Next Signal sign that is sometimes used in advance of signalized intersections. As an alternative to advance Street Name signs, a method to reduce sign clutter on roundabout approaches is to place advance street name plaques (W16-8 or W16-8a) above or below the Circular Intersection sign (W2-6), as described in Section 7.4.2.1.

Overhead guide signs are another option for communicating destination and lane-use information on the roundabout approach. Overhead signing has been implemented at various locations throughout North America and may provide benefits, particularly on three-lane roundabouts. Overhead signing reduces the chances for truck or other large vehicles to obscure the view of a roadside mounted guide sign. However, a potential drawback is that driver’s attention is diverted upward toward the sign instead of on the roadway ahead. The roundabout environment, complexity of information being presented, and approach geometry

Roundabouts: An Informational Guide

Exhibit 7-23
Advance Street Name Sign
for Use at Roundabouts
(D3-2)



should be considered in the selection of roadside mounting versus overhead mounting of guide signs.

7.4.3.2 Exit and Departure Signs

Exit guide signs (D1-1d and D1-1e) are recommended to designate the destinations of each exit from the roundabout (Exhibit 7-24). These signs are similar to conventional intersection direction signs or directional route marker assemblies except that a diagonal upward pointing arrow should be used. These signs can be placed either on the right-hand side of the roundabout exit or in the splitter island. Where feasible, placement within the splitter island is recommended to maximize visibility of the sign.

For roundabouts involving the intersection of one or more numbered routes, route confirmation assemblies should be installed directly after the roundabout exit. These provide drivers with reassurance that they have selected the correct exit at the roundabout. These assemblies should be located no more than 100 ft (30 m) beyond the intersection in urban areas and 200 ft (60 m) beyond the intersection in rural areas. Where there are pedestrian crossings on the exit leg, these signs should be placed after the crosswalk.

Exit guide signs reduce the potential for disorientation.

Exhibit 7-24
Exit Guide Signs



D1-1e



D1-1d

7.4.3.3 Example Sign Layout for Guide Signs for Roundabouts

Exhibit 7-25 illustrates examples of layouts for guide signs at roundabouts. Regulatory and warning sign examples are included in Section 7.4.2.5.

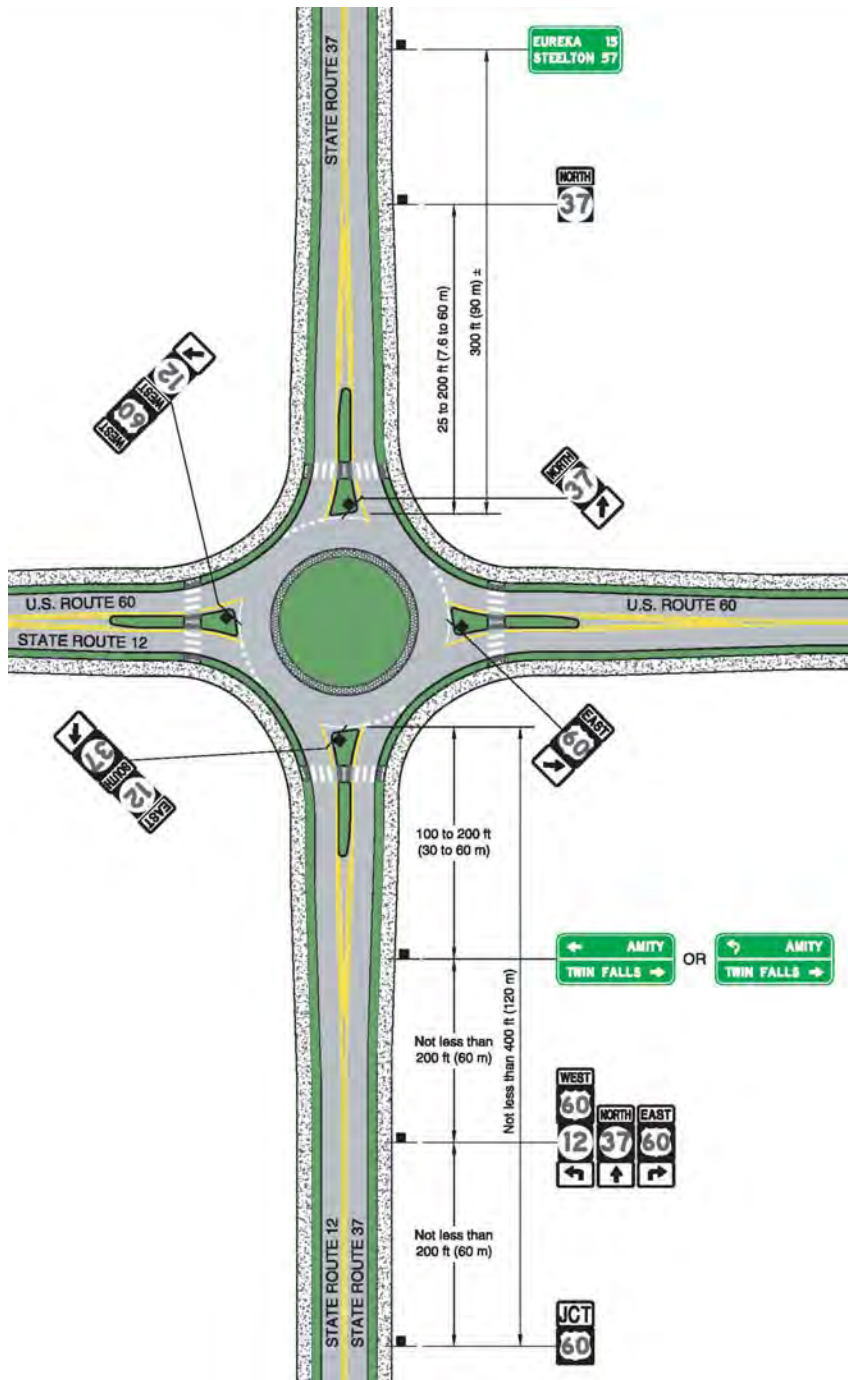

Exhibit 7-25
Example Sign Layout for
Guide Signs at Roundabouts

7.4.4 SUPPLEMENTAL TREATMENTS

Some agencies in the United States are experimenting with the use of flexible, internally illuminated bollards as a means to highlight the leading edge of a splitter island, particularly at mini-roundabouts where the central island is less visible. This is a common application in the United Kingdom, where the illuminated bollards are combined with a Keep Left sign, as shown in Exhibit 7-26. If combined with a Keep Right sign, the sign mounting height requirements of MUTCD Section 2A.18 apply.

Roundabouts: An Informational Guide

Exhibit 7-26
Internally Illuminated Bollard



Cambridge, England, United Kingdom

In cases where high approach speeds are expected [in excess of 50 mph (80 km/h)] and physical conditions suggest the need for treatments supplemental to the geometric design and traffic control devices described elsewhere in this document, the following measures may also be considered. (Examples of some of these treatments are given in Exhibit 7-27.)

- Warning beacons supplementing approach warning signs (see MUTCD Section 4L.03),

Exhibit 7-27
Examples of Speed Reduction Treatments



(a) Warning beacons (Leeds, Maryland) (b) Dynamic speed warning signs (Leeds, Maryland)



(c) Rumble strips (Paola, Kansas)

- Rumble strips placed in advance of the roundabout,
- Speed-reduction markings placed transversely across travel lanes (see MUTCD Section 3B.22), and
- Vehicle-activated speed warning signs commonly triggered by speeds exceeding an acceptable threshold.

These supplemental treatments can be considered for one or more approaches as conditions warrant. Note that roundabouts have been installed in high-speed environments without the use of any of the above treatments, so none of these should be viewed as essential.

7.5 SIGNALIZATION

There are some situations where it can be beneficial to use traffic signals to supplement the yield control used at roundabout entries. Signalization at roundabouts can include metering signals for one or more entries or pedestrian signals at roundabout pedestrian crosswalks. This section discusses each of these techniques and also briefly discusses full signalization of the circulatory roadway.

7.5.1 METERING

During peak periods, it is possible for the flow from one entry to dominate downstream entries to the point where insufficient gaps are available, causing excessive delays and queues at the downstream entry. In these cases, entrance metering can provide significant operational benefits during these peak periods. In some cases, metering may be a more economical solution than geometric improvements, especially if the traffic condition requiring metering is of a short duration.

A basic metering system consists of two components:

1. A queue detector on the downstream entry that is experiencing excessive delays and queues. The queue detector should be placed relatively far back on the downstream entry to detect when there is a long queue that has formed due to the congestion. When a long queue is detected, the signal controller activates the metering signal.
2. A metering signal on the dominant approach, preferably set far enough back from the entry to minimize confusion with the yield sign. If the metering signal cannot be set back sufficiently, some countries (e.g., Australia) use a special changeable message sign that shows a yield sign but can be changed to read “Stop on Red Signal.”

An example of a simple metering system is shown in Exhibit 7-28.

Another method of metering is the use, with appropriate timing, of a nearby upstream signalized intersection on the subject approach road. Unlike pure entry metering, such controls may stop vehicles from entering and leaving the roundabout. Expected queue lengths on the roundabout exits between the metering signal and the circulatory roadway should be compared with the proposed queuing space.

Metering can be effective in managing peak-period flow patterns.

Roundabouts: An Informational Guide

Exhibit 7-28

Example Diagram Showing Metering Signal Operation in Clearwater, Florida

Nearby intersection signals can also meter traffic, but are not as effective as direct entrance metering.

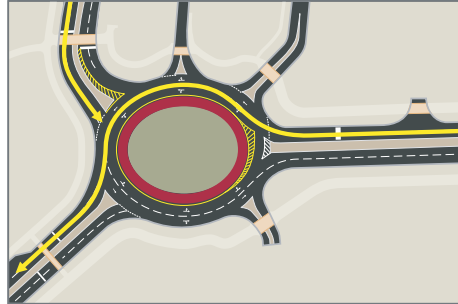

Without metering signal: At peak times traffic from the east flows continuously, blocking traffic entering from the north.

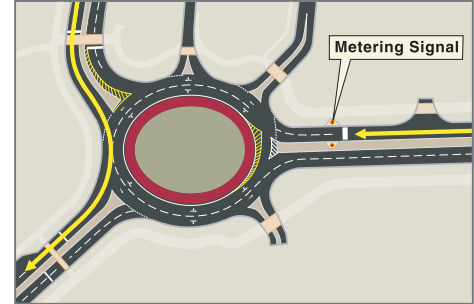

Metering signal briefly stops traffic from the east, which allows traffic from the north to enter the roundabout.

Because of additional objectives and constraints, metering by upstream signals is generally not as effective as direct entrance metering. More than one entrance can be metered, and the analyst needs to identify operational states and evaluate each one separately to provide a weighted aggregate performance measure.

Exhibit 7-29 gives examples of metering signals.

Exhibit 7-29

Examples of Metering Signals



(a) Approach metering signal
Clearwater, Florida



(b) Approach metering signal
Melbourne, Victoria, Australia



(c) Combination metering signal and changeable yield sign
Brisbane, Queensland, Australia

7.5.2 PEDESTRIAN SIGNALS AT ROUNDABOUTS

There are several situations where it may be beneficial to signalize pedestrian crossings at roundabouts. At first it may seem contradictory to add pedestrian signals at roundabouts since roundabouts are often used as a preferred alternative to signalized intersections. In addition, pedestrian signals add cost to the roundabout that is already implicit in the signalized intersection alternative. However, it is important to note that signalized pedestrian crossings at roundabouts are fairly simple when compared to signalization at the large signalized intersections, and in some cases they may provide critical accessibility for all users.

Signalized pedestrian crossings may be beneficial at roundabouts under at least the following conditions:

- *High vehicular volumes.* In areas with high vehicular volumes and moderate pedestrian activity, the number of available gaps for pedestrians to cross (assuming no vehicular yielding) may be insufficient for the volume of pedestrian traffic. In these cases, a pedestrian signal meeting the traditional MUTCD pedestrian signal warrants may be beneficial.
- *High pedestrian volumes.* In areas with high pedestrian volumes, continuous or frequent pedestrian crossing activity can have a significant negative impact on motor vehicle capacity. In these situations, it may be appropriate to install pedestrian signals to meter the flow of pedestrians, allowing motorists to clear the crosswalks to enter and exit the roundabout.
- *Accessibility at more complex crossing situations.* At most roundabouts, most pedestrians have little difficulty crossing the roadway due to the pedestrian features provided (as described in Chapter 6). However, as the number of lanes increase, the task of crossing becomes more complex for pedestrians and potentially impossible for pedestrians with vision impairments (see Chapter 2). Signalization of crosswalks is one possible treatment for improving the consistency of motorist yielding and the ability of all pedestrians to identify that it is safe to cross, particularly those with vision impairments. The current draft PROWAG includes a requirement to install accessible pedestrian signals at all crosswalks across any roundabout approach with two or more lanes in one direction. The PROWAG requirement does not specify the type of signal except that it must be accessible, including a locator tone at the pushbutton and audible and vibrotactile indications of the pedestrian walk interval.

7.5.2.1 Crossing Operation and Alignment Considerations

Perhaps the most important design consideration when considering a pedestrian signal is the advantage gained by operating the crossing in two stages. A traditional single-stage pedestrian signal can result in a significant amount of delay to vehicular traffic, potentially backing up exiting traffic into the roundabout. The provision of a two-stage pedestrian signal can significantly decrease delay to motorists while providing appropriate signalization for pedestrians, including those who are blind or have low vision. At a two-stage signalized pedestrian crossing, there are two separate pedestrian walk intervals, one for crossing the entry roadway and one for crossing the exit roadway.

Roundabouts: An Informational Guide

Where two-stage pedestrian crossings are used, care must be taken in the design and placement of the pedestrian signals. If two pedestrian signals for different walk intervals can be seen from the nearside, pedestrians might see the wrong signal and inadvertently cross at the inappropriate time. In addition, at most places where pedestrians push a button at a traffic signal, they receive a walk interval that takes them all the way across the street. At a two-stage crossing they only cross one half at a time; therefore, it is important to design the crossings and walkways in a way that reminds pedestrians that something different is occurring at these crossings. There are two methods to resolve these concerns.

First, as described in Section 6.8, one option for the crosswalk alignment at roundabouts is to place each leg of the crosswalk approximately perpendicular to the outside curb of the circulatory roadway for both the entry lane(s) and the exit lane(s). This creates an angle point in the walkway on the splitter island. However, if the splitter island is too narrow, the angle point may be too subtle to prevent pedestrians from mistakenly observing the wrong signal (see Exhibit 7-30). In addition, care is needed when locating accessible pedestrian signals within 10 ft (3 m) of each other on the splitter island to provide non-conflicting audible messages. A wider splitter island simplifies both display options and accessible messages.

Exhibit 7-30
Pedestrian Signal Placement
at Angled Crosswalk

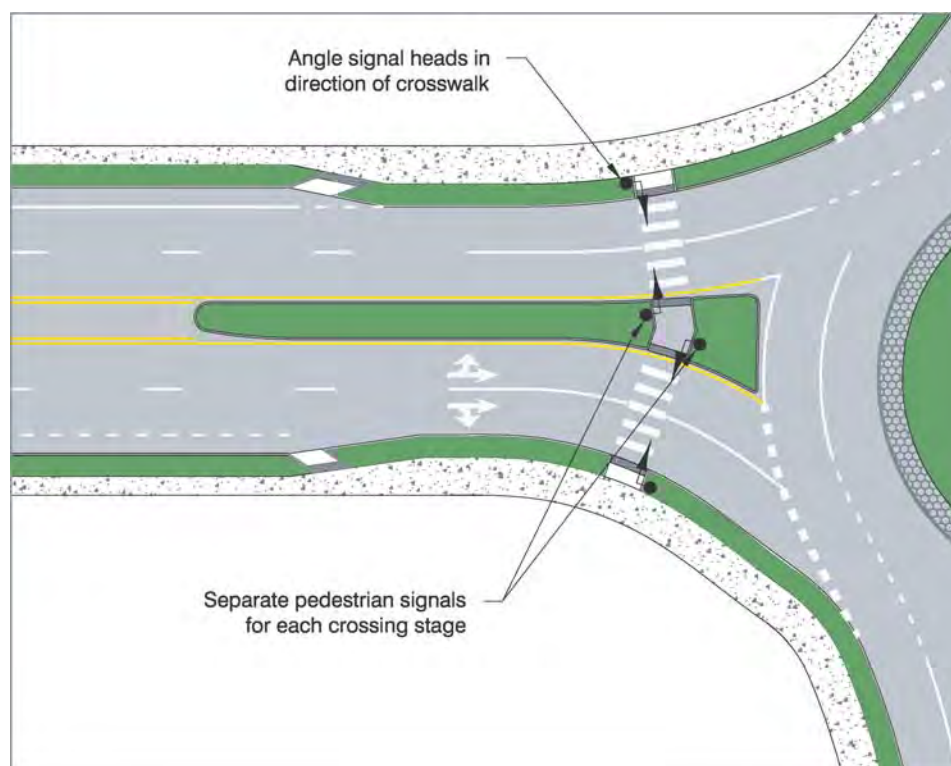

The second, more definitive method to resolve the concerns above is to offset the two crosswalks by providing a staggered walkway within the splitter island, as shown in Exhibit 7-31. The offset clearly indicates to pedestrians that there are two separate stages to the pedestrian signal, and it moves the pedestrian signal heads away from each other so that pedestrians will not be likely to observe the



(a) Overall perspective (Gatineau, Quebec, Canada)



(b) View of exit signal (Gatineau, Quebec, Canada)

Exhibit 7-31
Pedestrian Signal Placement
at Staggered Crosswalk

wrong signal. If an offset is provided, it is beneficial to provide landscaping or a railing in the splitter island to guide pedestrians to the crosswalks. At mid-block crossing locations with raised medians, it is normally preferred that the crosswalks be offset to the right; this forces pedestrians to look toward the approaching traffic in the lanes they will be crossing next. This could also be done at a roundabout pedestrian crossing. However, at a signalized pedestrian crosswalk at a roundabout, it can be beneficial to offset the crosswalks to the left, as shown in Exhibit 7-31, which moves the crosswalk for the exit lanes further away from the circulatory roadway. This provides more storage for stopped vehicles at the signal, reducing the likelihood that traffic will back up into the circulatory roadway.

7.5.2.2 Traditional Red-Yellow-Green Signals

Traditional red-yellow-green traffic signals can be used at roundabout crosswalks in a manner similar to a typical mid-block signalized pedestrian crossing.

The signal would rest in green for motorists entering and exiting the roundabout, and the pedestrian signal head would display the steady upraised hand symbolizing “don’t walk.” When the signal is actuated by a pedestrian, the vehicle signal would change to yellow and then red, after which the pedestrian signal head displays a walking person symbolizing the walk interval and then the flashing upraised hand symbolizing the pedestrian clearance interval.

The key design consideration when considering traditional red-yellow-green signals is the potential for motorist confusion between the green display at the crosswalk and the yield sign at the entry. For this reason, if traditional red-yellow-green signals are used, they should be located far enough away from the roundabout to minimize the likelihood of confusion. Other display types as discussed below may be preferable.

7.5.2.3 Pedestrian Hybrid Beacons (HAWK signals)

The 2009 MUTCD includes a new traffic control device called the pedestrian hybrid beacon (also commonly referred to as a HAWK signal). This device has a unique signal display that is intended to provide a red device to stop traffic to allow pedestrians to cross, while creating less delay to vehicular traffic than a normal red-yellow-green signal. The vehicular signal head is a three-section head with two red signal sections above a single yellow signal section. The display sequence provided in the MUTCD is shown in Exhibit 7-32. A normal pedestrian signal head is displayed to pedestrians at the crosswalk. When the beacon is actuated by a pedestrian, the vehicle signal goes from dark, to flashing yellow, steady yellow, then steady red during the pedestrian walk interval. The vehicle signal then displays alternating flashing red during the pedestrian clearance interval. As indicated in state vehicle codes, a flashing red signal has the same meaning as a stop sign, so drivers would be allowed to proceed through the crosswalk after stopping if the pedestrian has cleared their portion of the crosswalk. Because drivers can proceed once a pedestrian clears the crosswalk, the pedestrian hybrid beacon is likely to result in less delay to motorists than a traditional red-yellow-green signal, even with both operating in two-stage operation.

Section 4F.03 of the MUTCD provides additional provisions for the use of pedestrian hybrid beacons at roundabouts. In particular, the pedestrian signal heads may be dark (rather than displaying the upraised hand) while the pedestrian-actuated signal is also dark. This allows pedestrians to cross the roadway without

Exhibit 7-32
Display Sequence for a Pedestrian Hybrid Beacon

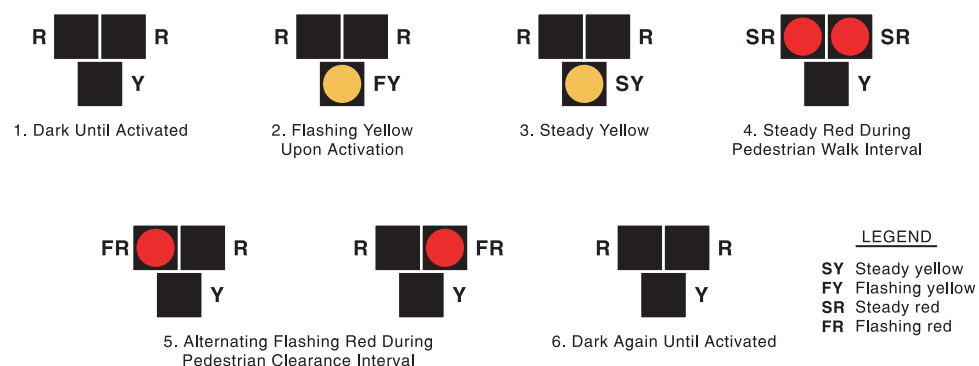

activating the pedestrian signal if they so desire, which can further reduce delay to motor vehicles.

7.5.2.4 Other Displays

There may be advantages to experimenting with other signal displays for pedestrian crossings at roundabouts to find the best solution. These types of signal displays not currently allowed by the MUTCD are subject to MUTCD Section 1A.10 “Interpretations, Experimentations, Changes, and Interim Approvals.”

7.5.2.5 Warning Beacons at Pedestrian Crossings

Yellow flashing warning beacons have been shown to increase the percentage of drivers who yield to pedestrians, which could potentially benefit pedestrians at roundabouts. Exhibit 7-33(a) gives one example of a pedestrian-activated warning beacon at a roundabout crosswalk. Current and future research will evaluate the potential for flashing beacons to improve accessibility for pedestrians who are blind or have low vision. For example, a beacon could be installed that starts flashing after being actuated by a pushbutton, and a speaker at the pushbutton transmits a verbal message that says “Flashing beacons are activated, but traffic may not stop.”

In addition to traditional round yellow flashing beacons, rectangular rapid flashing beacons, as shown in Exhibit 7-33(b), can be used at pedestrian crossings at roundabouts. Although not yet included in the MUTCD, rectangular rapid flashing beacons have been given interim approval by FHWA as they have been shown to be more effective in increasing yielding rates compared to traditional round yellow beacons.



(a) Traditional Yellow Round Beacon
Gatineau, Quebec, Canada



(b) Rectangular Rapid Flash Beacon
St. Petersburg, Florida

Exhibit 7-33
Examples of Warning
Beacons at Pedestrian
Crossings

7.5.3 SIGNAL MOUNTING LOCATION

While the MUTCD allows for both post-mounted signals and overhead signals, overhead signals are used at most signalized intersections because they have been shown to provide safer operation than post-mounted signals, especially at large intersections with high approach speeds and high volumes of traffic. However, because roundabouts are typically slow-speed environments by design and there is

no need for left- or right-turn signal heads, post-mounted signals have often been deemed to be sufficient where signals are used at roundabouts. This is especially true at two-lane approaches to roundabouts where approaching drivers will have a post-mounted signal immediately adjacent to their lane. On approaches with three or more lanes, overhead signals may provide better visibility, especially to the middle lane(s).

The use of post-mounted signals can significantly reduce the cost of installing pedestrian signals at roundabouts, and they may fit in better with the urban design goals where roundabouts are used in urban areas. Post-mounted signals may also be desirable because they keep drivers' focus near the roadway where they can easily see the queue of vehicles approaching the yield line; overhead signals may draw drivers' attention off of the roadway, possibly increasing the likelihood of rear-end crashes.

7.5.4 FULL SIGNALIZATION OF THE CIRCULATORY ROADWAY

Full signalization that includes control of circulating traffic at junctions with major entrances is possible at large-diameter multilane traffic circles or rotaries that have adequate storage space on the circulatory roadway. In these cases, the roundabout operates as a ring of coordinated signalized intersections and thus has operational characteristics that can be quite different from those described in this document.

A detailed discussion of full signalization is outside the scope of this document.

7.6 AT-GRADE RAIL CROSSINGS

Locating any intersection near an at-grade railroad crossing is generally discouraged. However, this is sometimes unavoidable and roundabouts are occasionally used near railroad-highway at-grade crossings. Rail transit, including stations, has also successfully been incorporated into the medians of approach roadways to a roundabout, with the tracks passing through the central island. In such situations, the roundabout either operates partially during train passage or is completely closed to allow the guided vehicles or trains to pass through. Where an at-grade rail crossing is provided at a roundabout, design consideration should include the provision of traffic control (such as crossing gates and flashing lights) at the grade crossing consistent with treatments at other highway-rail grade crossings. The treatment of at-grade rail crossings should primarily follow the recommendations of the MUTCD. Another relevant reference is the FHWA *Railroad-Highway Grade Crossing Handbook* (2).

Where roundabouts include or are in close proximity to a highway-rail grade crossing, a key consideration is the accommodation of vehicle queues to avoid queuing across the tracks. The MUTCD requires an engineering study to be conducted for any roundabout near a highway-rail grade crossing to determine queuing could affect the rail crossing and to develop provisions to clear the highway traffic from the highway-rail grade crossing prior to arrival of a train (1).

There are three common ways in which rails can interact with a roundabout:

1. Within the roadway median and through the center of the roundabout,
2. Diagonally through the center of the roundabout, or
3. Across one leg in close proximity to the roundabout.

Under any of the scenarios, highway traffic must not be forced to stop on the tracks. Where railroad gates are used to stop traffic, the gate placement and sequencing of the gates should be given careful consideration to allow all exiting traffic to clear the tracks prior to the train arriving.

A gated rail crossing through the center of a roundabout can be accommodated in two ways.

1. Provide gates across only the at-grade rail crossing or
2. Provide gates across the at-grade rail crossing and across all roundabout entries.

Issues to consider when designing such a crossing include but are not limited to the following:

- Location of the crossing relative to the roundabout.
- Traffic patterns and availability of queue storage.
- The use of railroad gates versus highway signals. Railroad signals fail-safe in that a loss of power drops the gate. Highway signals fail in flash or ultimately go dark.
- Preemption sequence and timing, including queue clearance, train speed, and other factors.

Three common scenarios occur in practice. The first and most likely is where rails run parallel to the highway and cross one leg of the intersection, discussed in Exhibit 7-34. A second scenario is where rails pass diagonally through the central island of the roundabout, discussed in Exhibit 7-35. A third scenario is where rails run down the median of a roadway and pass through the central island of the roundabout, discussed in Exhibit 7-36.

Other countries have considerable experience with the application of roundabouts near or incorporating at-grade rail crossings. While not inclusive of all international experiences, two examples are as follows:

- The city of Melbourne in Victoria, Australia, has several roundabouts with tram crossings running along the median through the center of the roundabout. These are either signalized or left uncontrolled.
- France also has considerable experience with at-grade rail crossings near roundabouts (3).

Caution is recommended when applying international at-grade rail crossing experience to the United States due to differing laws, regulations, standards, and user experience.

Roundabouts: An Informational Guide

Exhibit 7-34
 Rail Crossing One Leg of the
 Intersection

<p align="center">(a) Gates at all Entries</p>	<p align="center">(b) Gates on Rail Approach Only</p>
<ul style="list-style-type: none"> • Allows all exiting vehicles to clear roundabout prior to train arriving. • Introduces increases in delay, particularly where the predominant movement is through traffic parallel to the rail. • Preferred where the rail crossing is close to the roundabout and insufficient storage is available between the roundabout and rail. 	<ul style="list-style-type: none"> • Reduces delays at roundabout by allowing $\frac{3}{4}$ of the roundabout movements to continue to operate normally with train present. • Requires careful review of separation to rail line and available storage capacity.

<p>(a) Gates at all Entries</p>	<p>(b) Gates on the Circulatory Roadway</p>
<ul style="list-style-type: none"> • Maximizes safety by stopping all entering vehicles to prevent interaction with the rail. • Introduces minor increases in delay, particularly where there are heavy right turns. • Preferred at small-diameter roundabouts where queue storage on the circulatory roadway is limited. 	<ul style="list-style-type: none"> • Minor benefits from a delay standpoint where there are heavy right turns that can be accommodated while the train is present. • Most practical at larger diameter roundabouts where queue storage is available for through and left-turn vehicles.

Exhibit 7-35
 Rail Crossing through Center
 of Roundabout

Roundabouts: An Informational Guide

Exhibit 7-36
 Rail Running down
 Roadway Median

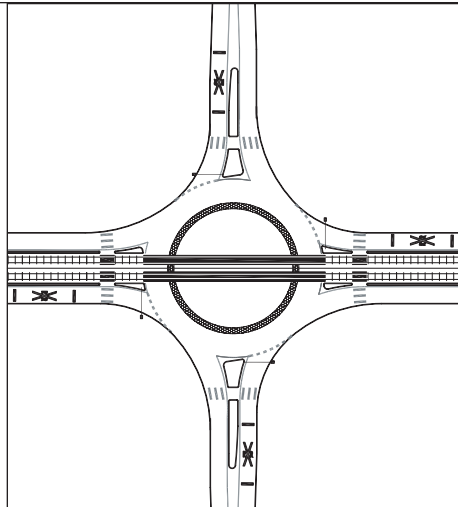
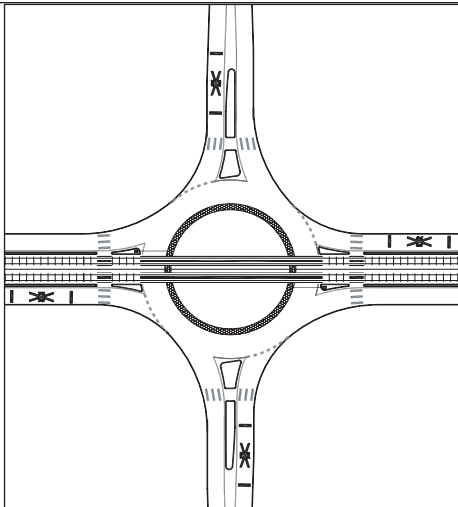
	
<p style="text-align: center;">Gates at all Entries</p>	<p style="text-align: center;">Gates on the Circulatory Roadway</p>
<ul style="list-style-type: none"> • Maximizes safety by stopping all entering vehicles to prevent interaction with the rail. • Introduces additional delay. 	<ul style="list-style-type: none"> • Consider use where: <ul style="list-style-type: none"> – Left-turn volume across tracks is low, – Large diameter present to store left-turn vehicles, – Multilane roundabout that allows through vehicles to bypass queues. • Provides reduced delay • Introduces simultaneous conflicts between rail, queued vehicles, and through traffic.

7.7 REFERENCES

1. *Manual on Uniform Traffic Control Devices for Streets and Highways*. FHWA, Washington, D.C., 2009.
2. *Railroad-Highway Grade Crossing Handbook*, 2nd ed. Publication No. FHWA-SA-07-010. FHWA, Washington, D.C., 2007.
3. *Safety at Level Crossings: Case of Proximity to a Roundabout*. Sétra (Service d'Études Techniques des Routes et Autoroutes), Bagnex, France, 2007 (translation).

**CHAPTER 8
ILLUMINATION**

CONTENTS

8.1 INTRODUCTION 8-3

8.2 GENERAL CONSIDERATIONS 8-3

8.3 LIGHTING LEVELS 8-5

8.4 EQUIPMENT TYPE AND LOCATION 8-6

 8.4.1 Equipment Type 8-6

 8.4.2 Pole Locations 8-6

 8.4.3 Example Illumination Layouts 8-9

8.5 REFERENCES 8-11

LIST OF EXHIBITS

Exhibit 8-1 Recommended Illuminance Levels for Roundabouts 8-5

Exhibit 8-2 Common Types of Illumination Equipment Used at Roundabouts .. 8-6

Exhibit 8-3 Styles of Lighting Assemblies 8-7

Exhibit 8-4 Summary of Advantages and Disadvantages of
Perimeter and Central Illumination 8-8

Exhibit 8-5 Photometric Illustration of Central and Perimeter
Illumination Design 8-8

Exhibit 8-6 Example of Illumination Using Cobra-Style Luminaires 8-9

Exhibit 8-7 Example of Illumination Using Pedestrian-Level Luminaires 8-10

Exhibit 8-8 Example of Illumination Using a Mix of Cobra-Style
and Pedestrian-Level Luminaires 8-10

8.1 INTRODUCTION

For a roundabout to operate satisfactorily, a driver must be able to enter the roundabout, move through the circulating traffic, and separate from the circulating stream in a safe and efficient manner. Pedestrians must also be able to safely use the crosswalks. To accomplish this, a driver must be able to perceive the general layout and operation of the intersection in time to make the appropriate maneuvers. Adequate lighting should therefore be provided at all roundabouts.

Adequate lighting should be provided at all roundabouts.

The *Design Guide for Roundabout Lighting*, published by the Illuminating Engineering Society (IES), is the primary resource that should be consulted in completing a lighting plan for a roundabout (1). The IES design guide provides recommendations for lighting of roundabouts, including light levels within the roundabout and vertical light levels at locations where pedestrians and bicycles are present. Other documents that could also provide assistance when completing a design include:

- *An Information Guide for Roadway Lighting* by AASHTO (2);
- *Standard Specifications for Structural Supports for Highway Signs, Luminaires and Traffic Signals* by AASHTO (3);
- *Roadway Lighting Design Guide* by AASHTO (4); and
- *American National Standard Practice for Roadway Lighting* by IES (5).

International references on lighting at roundabouts include the following:

- *Guide for the Design of Roadway Lighting* by the Transportation Association of Canada (6);
- *L'Éclairage des Carrefours à Sens Giratoire (The Illumination of Roundabout Intersections)* by CERTU (France) (7), and
- Australian/New Zealand Standard AS/NZS 1158.1.3:1997 (8).

8.2 GENERAL CONSIDERATIONS

Lighting of roundabouts serves two main purposes:

1. It provides visibility from a distance for users approaching the roundabout; and
2. It provides visibility of the key conflict areas to improve users' perception of the layout and visibility of other users within the roundabout. (1)

An important lighting consideration at roundabouts is that the roundabout introduces geometry and channelization that a driver may not expect unless it is visible at all times. In addition, the effectiveness of auto headlights is limited in a roundabout due to the constrained curve radius, making the roadway lighting system very important for nighttime visibility of obstructions and hazards (1).

Lighting from the central island causes vehicles to be backlit and thus less visible.

To improve the users' understanding of the roundabout's operations, the illumination should be designed to create a break in the linear path of the approaching roadway and emphasize the circular aspect of the roundabout (1). To achieve this, the following features are recommended:

- The overall illumination of the roundabout should be approximately equal to the sum of the illumination levels of the intersecting roadways. Local illumination standards should also be considered when establishing the illumination at the roundabout to ensure that the lighting is consistent.
- If continuous roadway lighting is not present, transition lighting should be provided for driver adaptation and should be extended along each approach to the roundabout.
- Adequate illumination should be provided on the approach nose of the splitter islands, at all conflict areas where traffic is entering the circulating stream, and at all places where the traffic streams separate to exit the roundabout.
- Adequate illumination should be provided for pedestrian crossing and bicycle merging areas.
- Consideration should be given to the impact of the lighting system in various ambient lighting zones and on adjacent properties. In addition, care should be taken to minimize glare and light trespass. The *IES Design Guide for Roundabout Lighting* provides more detail on these topics (1).

Illumination of a roundabout is particularly beneficial when:

- One or more approaches are illuminated;
- An illuminated area in the vicinity can distract the driver's view; and/or
- Heavy nighttime traffic, including pedestrians and bicycles, is anticipated.

Continuity of illumination is desirable between illuminated areas and the roundabout itself (9). A driver may not see a roundabout located in an unlit area immediately beyond the illuminated area due to the time it takes for the human eye to adjust to differing light levels.

Illumination is recommended for all roundabouts, including those in rural environments. However, it can be costly to provide if there is no power supply in the vicinity of the intersection. Where lighting is not provided, the intersection should be well signed and marked (including the possible use of reflective pavement markers) so that it can be correctly perceived by day and night, recognizing that signing and markings alone cannot correct for the limited view of headlights when circulating.

In areas where only the roundabout is illuminated (no lighting is provided on the approach roadways), the scope of illumination needs to be carefully considered. Any raised channelization or curbing should be illuminated. A gradual illumination transition zone should be provided beyond the final trajectory changes at each exit (9). This helps drivers adapt their vision from the illuminated environment of the roundabout back into the dark environment of the

exiting roadway, which takes approximately one to two seconds. In addition, it is preferable to avoid short-distance dark areas between two consecutive illuminated areas (9). The AASHTO *Roadway Lighting Design Guide* recommends that lighting be extended a minimum of 400 ft (120 m) along each road connecting to the roundabout (4).

8.3 LIGHTING LEVELS

Exhibit 8-1 summarizes the IES recommended street illumination levels for roundabouts located in continuously illuminated streets. This exhibit also presents the roadway and pedestrian area classifications used for determining the appropriate illumination levels. Although some other documents, zoning bylaws, and agencies may define these roadway and pedestrian areas differently, the descriptions shown in Exhibit 8-1 should be used to determine the roundabout lighting levels.

Vertical luminance recommendations have also been developed to ensure adequate visibility for drivers approaching crosswalks with pedestrians. Based on the IES *Design Guide for Roundabout Lighting*, it is recommended that the average vertical luminance for a series of points 5 ft (1.5 m) in height, along the centerline of the crosswalk extending to the edge of the roadway, spaced at 1.65 ft (0.5 m), for each driving direction be equal to the required horizontal illuminance and uniformity for the roundabout (1).

Functional Classification	Maintained Average Horizontal Illuminance on the Pavement Based on Pedestrian Area Classification			E_{avg}/E_{min}
	High	Medium	Low	
Major/Major	3.4 fc (34.0 lux)	2.6 fc (26.0 lux)	1.8 fc (18.0 lux)	3:1
Major/Collector	2.9 fc (29.0 lux)	2.2 fc (22.0 lux)	1.5 fc (15.0 lux)	3:1
Major/Local	2.6 fc (26.0 lux)	2.0 fc (20.0 lux)	1.3 fc (13.0 lux)	3:1
Collector/Collector	2.4 fc (24.0 lux)	1.8 fc (18.0 lux)	1.2 fc (12.0 lux)	4:1
Collector/Local	2.1 fc (21.0 lux)	1.6 fc (16.0 lux)	1.0 fc (10.0 lux)	4:1
Local/Local*	1.8 fc (18.0 lux)	1.4 fc (14.0 lux)	0.8 fc (8.0 lux)	6:1

Major = Roadway system that serves as the principal network for through traffic flow.

Collector = Roadway servicing traffic between major and local streets.

Local = Streets primarily for direct access to residential, commercial, industrial, and other abutting property.

High = Areas with significant numbers of pedestrians expected to be on the sidewalks or crossing the streets during the hours of darkness. Over 100 pedestrians during the average annual peak hour of darkness, typically 18:00 to 19:00 hours.

Medium = Areas where lesser numbers of pedestrians use the streets at night. Between 11 and 100 pedestrians during the average annual peak hour of darkness, typically 18:00 to 19:00 hours.

Low = Areas with low volumes of nighttime pedestrian usage. Less than 11 pedestrians during the average annual peak hour of darkness, typically 18:00 to 19:00 hours.

*Note: Use values for local/local functional classification if roundabout is located on roadway without continuous lighting.

Source: Adapted from IES *Design Guide for Roundabout Lighting* (1)

Exhibit 8-1
Recommended Illuminance
Levels for Roundabouts

8.4 EQUIPMENT TYPE AND LOCATION

To determine the appropriate lighting equipment and pole location, a photometric analysis is required. The number of fixed objects in the public right-of-way adjacent to a roundabout should be considered when identifying optimal locations for lighting poles; fewer poles with higher intensity light fixtures minimize the number of fixed objects. The type of area should also be considered when determining the equipment type and location. In an urban area with a high level of pedestrian activity, it may be more appropriate to install illumination at lower mounting heights. In these cases, the illumination at lower mounting heights may need to be supplemented with taller, cobra-style assemblies to ensure adequate lighting is provided within the key conflict areas.

8.4.1 EQUIPMENT TYPE

A sample of typical illumination equipment types used at roundabouts is shown in Exhibit 8-2. The illumination equipment shown in Exhibit 8-2 can vary depending on the project and the specific jurisdiction. The appropriate agency staff and the power company for a particular jurisdiction can likely provide additional guidance on the type of illumination equipment that is recommended or even required.

Exhibit 8-2
Common Types of
Illumination Equipment Used
at Roundabouts

Type of Lighting Assembly	Typical Wattage	Typical Distribution	Common Mounting Height
Cobra-style	75 W–400 W HPS	Type II or III (full or semi cutoff)	30 to 50 ft (9 to 15 m)
Ornamental	75 W–200 W HPS	Type V (360° spread)	14 to 20 ft (4 to 6 m)
High-Mast	400 W–1,000 W HPS	Type V (360° spread)	50 to 100 ft (15 to 30 m)

W = watts; HPS = High Pressure Sodium
Source: Kansas Roundabout Guide (9)

Exhibit 8-3 illustrates example photographs of a range of equipment types used at roundabouts. Exhibit 8-3(a) shows a roundabout lit only with cobra-style assemblies (pole, arm, and light fixture), and Exhibit 8-3(b) shows a roundabout with a mix of cobra-style assemblies and shorter, ornamental assemblies. As the proportion of lights with lower mounting heights increases, the visibility of the central island from a distance decreases.

8.4.2 POLE LOCATIONS

The ability to provide adequate visibility at a roundabout is highly dependent on the illumination pole locations. Roundabout lighting can be achieved by installing lighting within the central island or around the perimeter of the inter-



(a) Cobra-style (Loveland, Colorado)



(b) Mixed ornamental and cobra-style (Bend, Oregon)

Exhibit 8-3

Styles of Lighting Assemblies

section. The IES *Design Guide for Roundabout Lighting* recommends lighting be placed around the perimeter of the roundabout and at locations on the approach side of the crosswalks. Perimeter illumination provides the most optimal visibility within the key conflict areas and visibility of circulating vehicles to vehicles approaching the roundabout. In addition, the vertical lighting level in the crosswalks cannot be achieved unless approach lighting is used (1). Therefore, roundabouts with central island illumination may require additional approach lighting or may be combined with perimeter illumination to achieve vertical lighting levels. Exhibit 8-4 summarizes some of the key advantages and disadvantages for each type of illumination design.

Exhibit 8-5 shows the distinct differences in the illumination on the central island and circulatory roadway between central and perimeter illumination. Both illumination designs include approach lighting.

The position of lighting poles relative to the curbs at a roundabout should also be considered and is influenced by the speed environment and the potential

Roundabouts: An Informational Guide

Exhibit 8-4
Summary of Advantages and Disadvantages of Perimeter and Central Illumination

Illumination Type	Advantages	Disadvantages
Perimeter illumination	<ul style="list-style-type: none"> • Illumination can be strongest around critical bicycle and pedestrian areas. • Continuity of poles and luminaires is maintained for the illumination of the lanes, as well as good visual guidance on the circulatory roadway. • Approach signs typically appear in positive contrast and thus are clearly visible. • Maintenance of luminaires is easier due to curbside location. 	<ul style="list-style-type: none"> • Illumination is weakest in central island, which may limit visibility of roundabout from a distance. • More poles are required to achieve the same illumination level. • Poles may need to be located in critical conflict areas to achieve illumination levels and uniformity.
Central illumination	<ul style="list-style-type: none"> • Perception of the roundabout is assisted at a distance by illuminating the central island. • Fewer poles are required to achieve the same illumination. • Pole in central island is clear of critical conflict areas for all but the smallest of roundabouts. • Exit guide signs on the periphery appear in positive contrast (front lit) and thus are clearly visible. 	<ul style="list-style-type: none"> • Cannot achieve adequate vertical lighting levels without additional approach lighting. • Illumination is weakest in critical pedestrian and bicycle areas. • Signs on the approach are in negative contrast (back lit). • A path is needed to the base of the central pole for maintenance. • There is a greater risk of glare. • The central pole affects central island landscaping plan. • High mast lighting may be inappropriate in urban areas, especially residential areas.

Source: Adapted from Kansas Roundabout Guide (9)

Exhibit 8-5
Photometric Illustration of Central and Perimeter Illumination Design

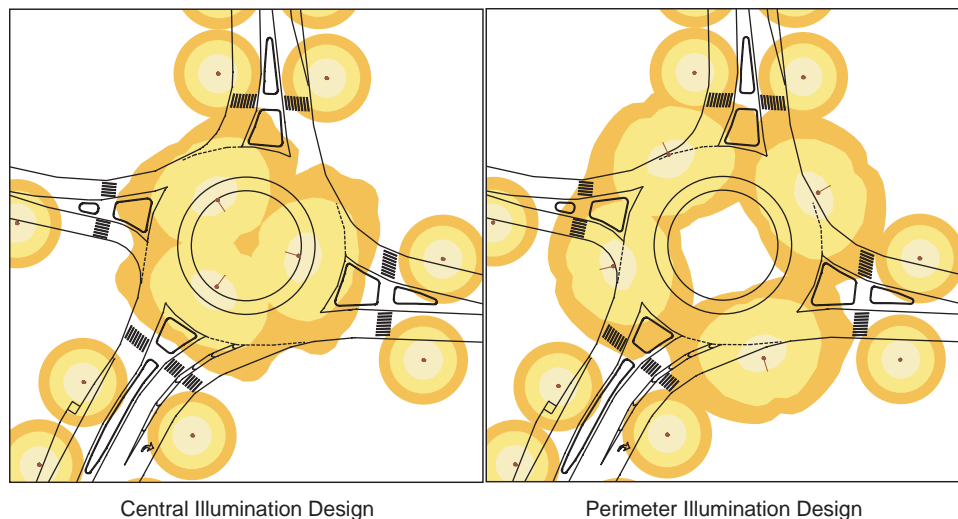

speeds of errant vehicles. In particular, care should be given to placement of poles along the exit leg of the roundabout to consider potential paths of errant vehicles that may not successfully navigate the exit curvature upon leaving the circulatory roadway. Single-vehicle crash rates involving out-of-control vehicles at roundabouts are high compared to other intersection types. Therefore, it is desirable to have adequate amounts of clear zone where there are no roadside hazards on each side of the roadway. The reader is encouraged to refer to the AASHTO *Roadside Design Guide (10)* and *Policy on Geometric Design of Highways and Streets (11)* for further discussion on clear-zone requirements.

8.4.3 EXAMPLE ILLUMINATION LAYOUTS

Exhibit 8-6 through Exhibit 8-8 present sample illumination plans demonstrating layouts using various types of lighting assemblies. Each illumination plan has been customized to the specific geometry of the roundabout, photometric requirements, equipment options, and site constraints. Caution is advised if attempting to adapt these plans to another location.

Inscribed Circle Diameter:	190 ft (58 m)
Equipment:	Luminaires over circulatory roadway: 400 W HPS, Type M-C-III, 37 ft (11.2 m) mounting height Remainder: 200 W HPS, Type M-C-III, 35 ft (10.7 m) mounting height
Photometric Requirements:	Avg. illuminance: 2.6 fc (26 lux) Avg./min. uniformity: 3:1
Layout:	

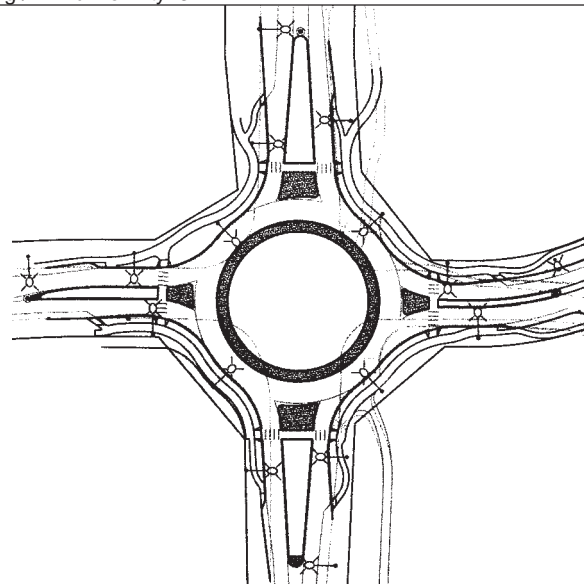

Source: Kansas Roundabout Guide (9)

Exhibit 8-6
Example of Illumination Using
Cobra-Style Luminaires

Roundabouts: An Informational Guide

Exhibit 8-7

Example of Illumination Using Pedestrian-Level Luminaires

Inscribed Circle Diameter:	120 ft (37 m)
Equipment:	Pedestrian-level luminaires: 250 W HPS, Type V, 18 ft (5.5 m) mounting height
Photometric Requirements:	Avg. illuminance: 2.7 fc (27 lux) Avg./min. uniformity: 3:1

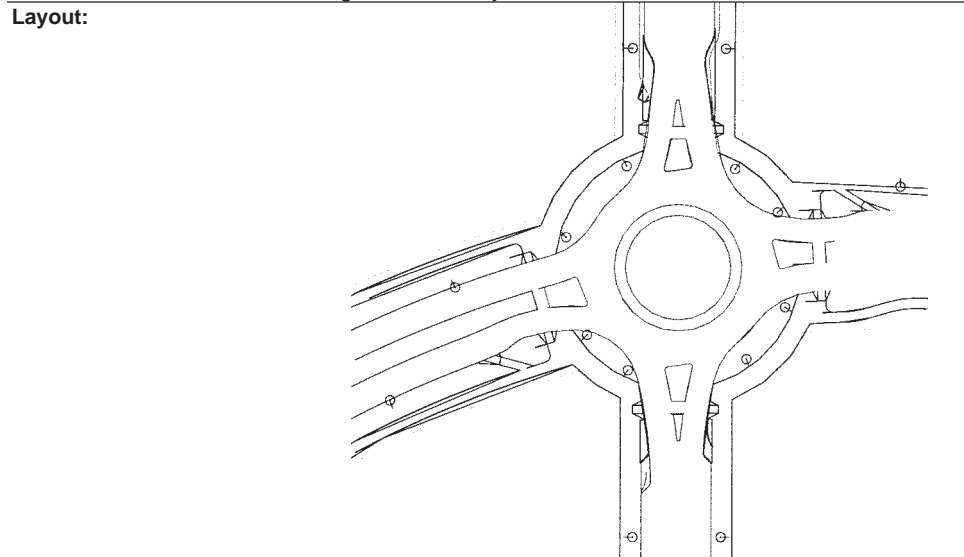

Source: Kansas Roundabout Guide (9)

Exhibit 8-8

Example of Illumination Using a Mix of Cobra-Style and Pedestrian-Level Luminaires

Inscribed Circle Diameter:	140 ft (43 m)
Equipment:	Cobras over circulatory roadway: 200 W HPS, Type M-C-III, 30 ft (9.1 m) mounting height Pedestrian-level luminaires: 200 W HPS, Type V, 14 ft (4.3 m) mounting height
Photometric Requirements:	Avg. illuminance: 2.0 fc (20 lux) Avg./min. uniformity: 3:1

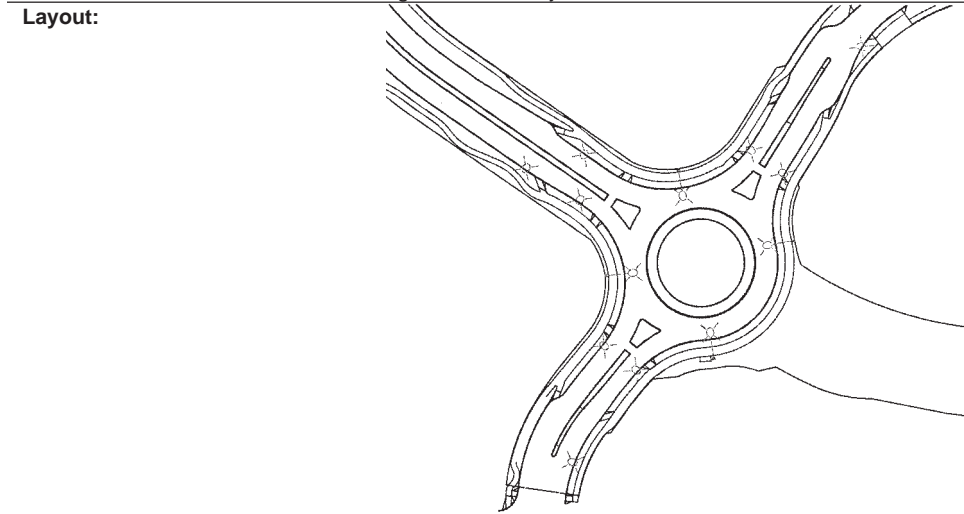

Source: Kansas Roundabout Guide (9)

8.5 REFERENCES

1. *Design Guide for Roundabout Lighting*. Publication IES DG-19-08. Illuminating Engineering Society of North America, New York, February 2008.
2. *An Information Guide for Roadway Lighting*. AASHTO, Washington, D.C., 1985.
3. *Standard Specifications for Structural Supports for Highway Signs, Luminaires and Traffic Signals*. AASHTO, Washington, D.C., 1994.
4. *Roadway Lighting Design Guide*. AASHTO, Washington, D.C., 2005.
5. *American National Standard Practice for Roadway Lighting*. Standard RP-8-00. Illuminating Engineering Society of North America, New York, 2005.
6. *Guide for the Design of Roadway Lighting*, 2006 ed. Transportation Association of Canada (TAC), Ottawa, Ontario, Canada, 2006.
7. *L'Éclairage des Carrefours à Sens Giratoire (The Illumination of Roundabout Intersections)*. Centre d'Études sur les Réseaux les Transports, l'Urbanisme et les constructions publiques (CERTU), Lyon, France, 1991.
8. *Road Lighting, Part 1.3: Vehicular Traffic (Category V) Lighting—Guide to Design, Installation, Operation and Maintenance*. Australian/New Zealand Standard AS/NZS 1158.1.3:1997. Standards Australia, Homebush, Australia, and Standards New Zealand, Wellington, New Zealand, 1997.
9. Kittelson & Associates, Inc., and TranSystems Corporation. *Kansas Roundabout Guide: A Supplement to FHWA's Roundabouts: An Informational Guide*. Kansas Department of Transportation, Topeka, Kansas, 2003.
10. *Roadside Design Guide*. AASHTO, Washington, D.C., 2006.
11. *A Policy on Geometric Design of Highways and Streets*. AASHTO, Washington, D.C., 2004.

**CHAPTER 9
LANDSCAPING**

CONTENTS

9.1 INTRODUCTION 9-3

9.2 PRINCIPLES 9-7

9.3 CENTRAL ISLAND LANDSCAPING 9-8

9.4 SPLITTER ISLAND AND APPROACH LANDSCAPING 9-13

9.5 MAINTENANCE 9-13

9.6 REFERENCES 9-15

LIST OF EXHIBITS

Exhibit 9-1 Examples of Landscaping 9-3

Exhibit 9-2 Summary of Roundabout Landscaping Zones 9-7

Exhibit 9-3 Landscaping Considerations as a Function of Diameter 9-8

Exhibit 9-4 Central Island Landscaping Profile 9-9

Exhibit 9-5 Example of Central Island Landscaping 9-9

Exhibit 9-6 Examples of Central Island Art 9-10

Exhibit 9-7 Landscaping Trade-Offs 9-12

Exhibit 9-8 Example of Splitter Island Landscaping Encroaching
on Sight Lines 9-13

Exhibit 9-9 Maintenance of Landscaping in Central Island 9-14

9.1 INTRODUCTION

Landscaping is one of the distinguishing features that give roundabouts an aesthetic advantage over traditional intersections. Landscaping in the central island, splitter islands (where appropriate), and along the approaches can benefit both public safety and community enhancement. In addition to landscaping, some agencies use the central island of a roundabout as an opportunity to display local art or other gateway features. To determine the type and quantity of landscaping or other material to incorporate into a roundabout design, maintenance, sight distance, and the available planting zones should all be considered. The primary objectives and considerations of incorporating landscaping or art into a roundabout design are to:

- Make the central island more conspicuous, thus improving safety;
- Improve the aesthetics of the area while complementing surrounding streetscapes as much as possible;
- Make decisions regarding placement of fixed objects (e.g., trees, poles, walls, guide rail, statues, or large rocks) that are sensitive to the speed environment in which the roundabout is located;
- Avoid obscuring the form of the roundabout or the signing to the driver;
- Maintain adequate sight distances, as discussed in Chapter 6;
- Clearly indicate to drivers that they cannot pass straight through the intersection;
- Discourage pedestrian traffic through the central island; and
- Help pedestrians who are visually impaired locate sidewalks and crosswalks.

Exhibit 9-1 provides a variety of landscaping examples.



(a) Carson City, Nevada

Maintenance, sighting distance, and available planting zones should be considered when designing landscaping.

Exhibit 9-1
Examples of Landscaping

Roundabouts: An Informational Guide

Exhibit 9-1 (cont.)
Examples of Landscaping



(b) Davis, California



(c) Monroe, Washington



(d) Denver, Colorado



(e) Coralville, Iowa



(f) Parkville, Missouri



(g) Perth, Western Australia, Australia

Exhibit 9-1 (cont.)
Examples of Landscaping

Roundabouts: An Informational Guide

Exhibit 9-1 (cont.)
Examples of Landscaping



(h) Towson, Maryland



(i) Reno, Nevada



(j) Anchorage, Alaska

9.2 PRINCIPLES

Landscaping should be designed to ensure that vehicles can observe the signing and shape of the roundabout as they approach and have adequate visibility for making decisions within the roundabout. As described in Chapter 6, the sight distance requirements at the roundabout dictate the size and types of landscaping materials appropriate for the various areas within and adjacent to the roundabout. Landscaping within the critical visibility areas must be limited to a height of 2 ft (0.6 m) to ensure adequate sight distance. The appropriate planting zones within a roundabout and the types of landscaping for each zone are described below.

The overall speed environment of the roadway is another important consideration when selecting plant material and other landscape features. Within lower-speed urban environments [typically 35 mph (55 km/h) or less], there is generally more flexibility than in higher-speed suburban and rural environments [typically 40 mph (65 km/h) or greater] where drivers are traveling at greater speeds upstream of the roundabout. Therefore, the types and location of landscape features are dependent on operating environment and the potential risk.

Exhibit 9-2 illustrates the typical landscaping zones within a roundabout.

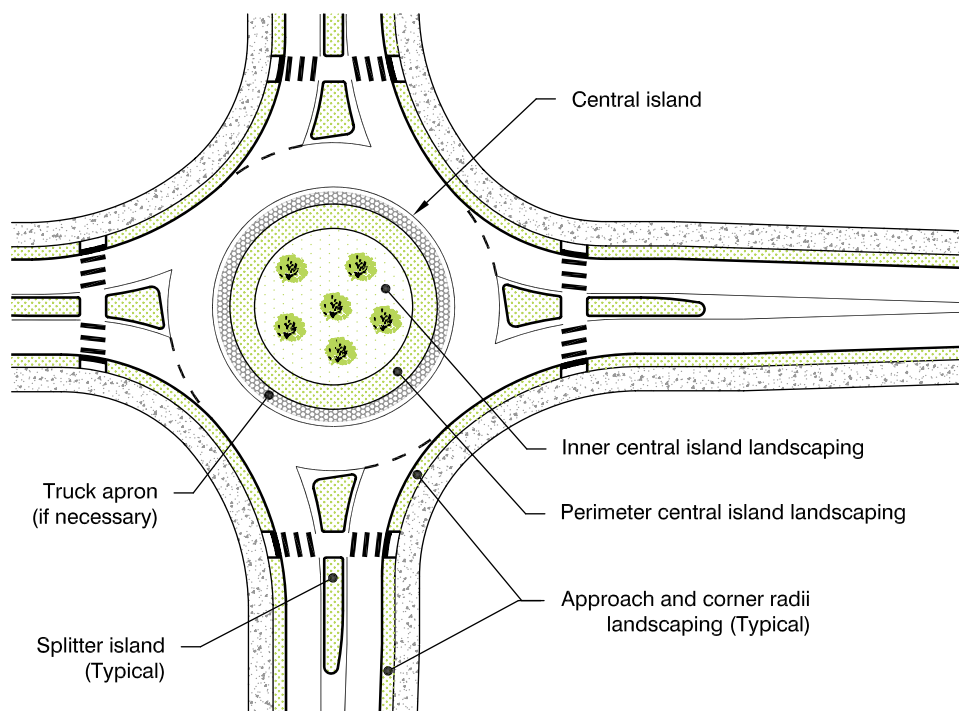

Exhibit 9-2
Summary of Roundabout
Landscaping Zones

9.3 CENTRAL ISLAND LANDSCAPING

The landscaping of the central island can enhance the safety of the intersection by making the intersection a focal point, by promoting lower speeds, and by breaking the headlight glare of oncoming vehicles. Landscaping elements should be selected so that sight distance (discussed in Chapter 6) is maintained where required. Conversely, the landscaping should also be strategically located to limit the amount of excess sight distance to help encourage slow speeds. This typically results in different types of landscaping being considered for the inner and outer portion of the central island, as described below. Landscaping plans must give consideration of future maintenance requirements to ensure adequate sight distance for the life of the project

It is desirable to create a domed or mounded central island to increase the visibility of the intersection on the approach. The Wisconsin Department of Transportation *Facilities Development Manual* recommends a minimum elevation of 3.5 ft (1.0 m) and a maximum elevation of 6 ft (1.8 m) for the domed area on the central island (1). In addition, the slope of the central island should not exceed a horizontal-to-vertical ratio of 6:1 in order to enable errant vehicles to recover (2). The size of the roundabout can influence the type and location of landscaping. Large and small diameter roundabouts have unique landscaping trade-offs that should be considered, as seen in Exhibit 9-3.

Exhibit 9-3
Landscaping Considerations
as a Function of Diameter

Large Diameter	Small Diameter
<ul style="list-style-type: none"> • There is more surface area for landscaping features. • A greater focal point for visibility is available as drivers approach the intersection. • There is greater opportunity to create a gateway feature for community enhancement. • A greater amount of landscaping is required, which requires initial installation cost and ongoing maintenance. • State and city agencies often cannot provide ongoing maintenance of roundabouts; therefore, an agreement with a local civic group and/or garden club may be necessary. • If limited maintenance is desired, hardscape features may be installed. • Central island landscaping features (trees, gateway features, hardscape) can create a potential fixed-object conflict, particularly for the high-speed approaching vehicles. 	<ul style="list-style-type: none"> • There is less surface area for landscaping features. • The limited surface area would likely require a lower initial installation cost and less ongoing maintenance. • Central island landscaping is likely not feasible, and the focus should be on the perimeter of the roundabout. • Perimeter landscaping does not typically provide the same visibility benefits to drivers approaching the roundabout. • A small central island provides less opportunity for gateway features in the center of the roundabout. • Less concern for fixed-object conflicts exists when trees and gateway features are not placed within the central island.

Care is needed when considering landscaping that introduces fixed objects within the central island, particularly in environments with higher approach speeds. While it is important to provide features that increase the visibility of the roundabout to approaching drivers, fixed objects such as trees, poles, walls, guide rail, statues, and large rocks can introduce potential safety concerns for errant vehicles. In most cases, fixed objects should be minimized, particularly in the

perimeter area of the central island. If used, fixed objects should preferably be placed in a location where the geometry of the roundabout deflects approaching vehicles away from the object.

In some cases, trees, shrubs, statues, and other larger items can be placed on the inner central island to help obscure the line of sight straight through the roundabout to provide drivers an indication that they cannot pass straight through the intersection. In addition, landscaping in this planting zone can make the roundabout more visible at night with the vehicle headlights illuminating the central island (3).

The perimeter portion of the central island can be landscaped with low-level shrubs, grass, or groundcover to ensure that stopping sight distance requirements are maintained for vehicles within the circulatory roadway and at the entrance line of the roundabout. The planting zone width around the perimeter of the central island will vary depending on the size of the roundabout and the required sight triangles. Exhibit 9-4 illustrates the two potential landscaping zones and possible landscape features within the central island. Exhibit 9-5 shows an example of proper landscaping within the central island.

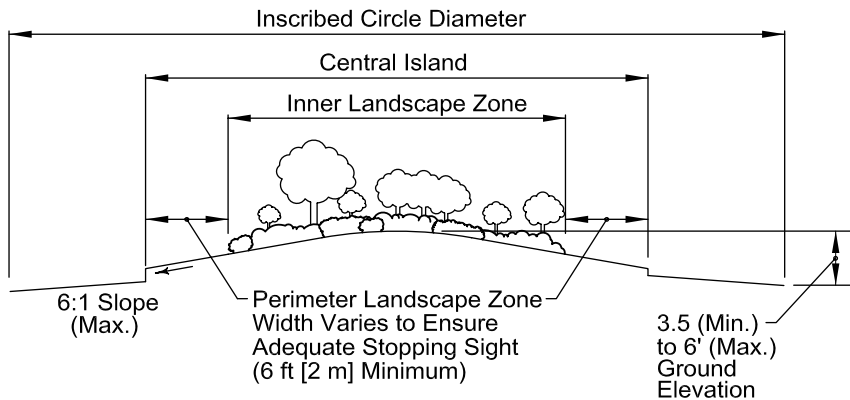

Exhibit 9-4
Central Island
Landscaping Profile



Avon, Colorado

Exhibit 9-5
Example of Central
Island Landscaping

Roundabouts: An Informational Guide

In northern climates, the salt tolerance of any plant material should be considered, as well as snow storage and removal practices. In addition, landscaping that requires watering may increase the likelihood of wet and potentially slippery pavement.

Landscaping within the central island should discourage pedestrian traffic to and through the central island. Street furniture that may attract pedestrian traffic to the central island, such as benches or monuments with small text, should be avoided.

Communities commonly desire to place public art or other large aesthetic objects within the central island, including statues, fountains, monuments, and other gateway features for community enhancement. This type of landscaping is acceptable provided that the objects are located outside the sight triangles and minimize the likelihood of a fixed-object conflict for errant vehicles. In addition, the central island features should not impact the vehicles circulating the roundabout. For example, fountains in windy areas can generate water spray that impacts drivers' visibility through the intersection.

In some areas, a roundabout design can help define a community, township, or region by displaying a piece of art that represents local heritage. This is particularly the case in European countries, where it is an honor for an artist to have art displayed in the central island of a roundabout, and communities look for ways to display their cultural characteristics through roundabout art (4). Exhibit 9-6 illustrates examples of central island art.

Exhibit 9-7 discusses the trade-offs of landscaping roundabouts.

Uplighting is an additional feature that some agencies use, particularly for trees or aesthetic features on the central island. While uplighting can provide an aesthetic nighttime feature by illuminating the trees or art, other agencies do not use uplighting due to its impact on the natural night sky.

Exhibit 9-6
Examples of Central
Island Art



(a) Federal Way, Washington



(b) Bend, Oregon



(c) Des Moines, Iowa



(d) Pemberton, British Columbia, Canada

Exhibit 9-6 (cont.)
Examples of Central
Island Art

Exhibit 9-7
Landscaping Trade-Offs

Example: Landscaping Trade-Offs

Scenario

A roundabout has been designed on a state highway on the eastern edge of a city. The east approach has a posted speed of 50 mph, and all other approaches have a posted speed of 35 mph. The state highway serves as the primary route through the city; therefore, the city would like the roundabout to serve as a community enhancement with aesthetic gateway features. The intersection has a crash history involving high-speed vehicles on the east approach; therefore, the city would like the roundabout to increase driver awareness and potentially reduce speeds of vehicles approaching the intersection.

Question

What are the trade-offs in installing landscaping?

Principles

The primary considerations for developing a landscaping plan for a roundabout include:

- Ensure visibility and sight distance for vehicles approaching and traveling through the roundabout,
- Identify potential speed-reduction measures for the east approach,
- Identify potential for fixed-object conflicts on the high-speed approach and review the recommended clear-zone and offset distances,
- Develop maintenance agreement with state and city agencies, and
- Create a gateway feature for the community.

Alternative 1: Install landscaping at the roundabout

- Creates opportunity for community enhancement through gateway features and aesthetics.
- Requires the development of a maintenance program.
- Requires additional construction cost to install landscaping.
- Provides visibility for drivers approaching the roundabout.
- Creates funneling effect at the roundabout entries.
- Encourages proper use of pedestrian walkways.
- Provides the opportunity for speed reduction and increased driver awareness on each approach by introducing changes in the roadway environment.

Alternative 2: Do not install landscaping at the roundabout

- Minimizes and even eliminates the need for maintenance.
- Reduces the construction costs.
- Provides less community enhancement.
- Does not provide as much visibility as drivers approach the roundabout.
- Creates the need for other visibility features to ensure that drivers do not pass straight through the intersection.
 - Additional approach signing.
 - Mounding the central island.
- Creates potential for improper pedestrian crossing.
- Reduces the concern for fixed-object conflicts.
- May require additional mitigation for high speeds on the east approach to reduce approach speeds.
 - Lengthen the splitter island.
 - Install speed-reduction treatments, such as rumble strips.
 - Dynamic warning signs.
 - Transverse pavement markings.

9.4 SPLITTER ISLAND AND APPROACH LANDSCAPING

When designing landscaping for the splitter islands and along the outside edges of the approach, care should be taken with the landscaping to avoid obstructing sight distance since the splitter islands are usually located within the critical sight triangles (see Chapter 6). Exhibit 9-8 gives an example where the vegetation in the splitter island is beginning to encroach on driver sight lines. In addition, landscaping should not obscure the form of the roundabout or signing to an approaching vehicle. Therefore, the size of the splitter islands and location of the roundabout are determining factors in assessing whether to provide landscaping within the splitter islands (1).



San Diego, California

Exhibit 9-8
Example of Splitter Island
Landscaping Encroaching on
Sight Lines

Landscaping on the approaches to the roundabout can enhance safety by making the intersection a focal point and by reducing the perception of a high-speed through-traffic movement. Plant material in the splitter islands (where appropriate) and on the right and left side of the approaches can help to create a funneling effect and induce drivers to slow down when approaching the roundabout. Landscaping between the sidewalk and the circulatory roadway will help to channelize pedestrians to the crosswalk areas and discourage pedestrian crossing to the central island.

Because a portion of the splitter island and the area between the sidewalk and the circulatory roadway are typically situated within the critical sight triangles, the landscaping in these areas may be constructed with low-growth plants or grass. Grass or low shrubs are also desirable due to their ability to blend well with nearby streetscapes and the fact that they require only limited maintenance. Splitter islands should generally not contain trees, planter boxes, or light poles. Hardscape treatments like a simple patterned concrete or paver surface may be used on splitter islands in lieu of landscaping.

9.5 MAINTENANCE

A realistic maintenance program should be considered in the design of the landscape features of a roundabout. Prior to developing a landscaping plan for a roundabout, the responsible party for future maintenance, water supply, drainage,

Roundabouts: An Informational Guide

and expected growth of the plantings should be addressed. Exhibit 9-9(a) shows an example of landscaping being maintained within the central island.

The agency or group responsible for maintaining the landscaping should be identified. It is generally necessary for local governments to assume maintenance responsibilities for the roundabout landscaping to provide enhancements to their communities. However, it may be unrealistic to expect a typical highway agency to maintain a complex planting plan. In these cases, formal agreements may be developed with local civic groups and garden clubs for maintenance. Liability issues should be considered in writing these agreements. Where there is no interest in maintaining the proposed enhancements, the landscape design should consist of simple plant materials or hardscape items that require little or no maintenance.

A water supply that is accessible to service vehicles should be provided on the central island or adjacent to the intersection. Landscaping that requires frequent watering may require installation of a sprinkler system. Proper drainage for the watering system should be provided and should minimize the water runoff onto the circulatory roadway. Watering systems with a mist-type spray should be avoided as water spray onto windshields could create safety concerns (1). In addition, proper access for maintenance vehicles to the central island and splitter islands should be considered. Potential stoppage or pullout areas for maintenance vehicles

Exhibit 9-9
Maintenance of Landscaping
in Central Island



(a) Central island maintenance (Decatur, Georgia)



(b) Maintenance pullout in central island (Bend, Oregon)

should be located such that visibility and access for vehicles and pedestrians is preserved (5). Exhibit 9-9(b) shows an example of a pullout area for maintenance vehicles.

It is important that the plants and trees within the roundabout do not interfere with the users' visibility within the roundabout. Therefore, the expected growth of specific plant and tree species included in a landscape plan should be considered. In addition, grass, trees, and shrubs should be regularly trimmed or pruned to prevent obstruction of the sight triangles and to maintain the aesthetics of the intersection (1).

9.6 REFERENCES

1. *Facilities Development Manual*. Wisconsin Department of Transportation, 2009.
2. *Roadside Design Guide*. AASHTO, Washington, D.C., 2006.
3. *Kansas Roundabout Guide*. Kansas Department of Transportation, 2005.
4. Institute of Transportation Engineers. *Enhancing Intersection Safety through Roundabouts: An ITE Informational Report*. Unpublished. July 2008 Draft.
5. *The Design of Interurban Intersections on Major Roads: At-Grade Intersections*. Sétra (Service d'Études Techniques des Routes et Autoroutes), Bagnaux, France, 1998.

CHAPTER 10

CONSTRUCTION AND MAINTENANCE

CONTENTS

10.1 INTRODUCTION	10-3
10.2 PUBLIC EDUCATION	10-3
10.3 CONSTRUCTION STAGING	10-4
10.3.1 Construction under No Traffic	10-4
10.3.2 Construction with Some Traffic Diverted	10-5
10.3.3 Construction under Full Traffic	10-8
10.4 WORK ZONE TRAFFIC CONTROL	10-10
10.4.1 Pavement Markings	10-10
10.4.2 Signing	10-11
10.4.3 Lighting	10-11
10.5 CONSTRUCTION PLANS	10-11
10.6 CONSTRUCTION COORDINATION	10-11
10.6.1 Contractor and Designer Coordination	10-12
10.6.2 Utility Coordination	10-12
10.7 MAINTENANCE	10-13
10.7.1 Landscaping Maintenance	10-13
10.7.2 Snow Removal	10-13
10.7.3 Pavement Maintenance and Rehabilitation	10-15
10.8 REFERENCES	10-16

LIST OF EXHIBITS

Exhibit 10-1 Example of Roundabout Informational Brochure 10-3
Exhibit 10-2 Example of Public Meeting Presentation Boards 10-4
Exhibit 10-3 Example of Construction under Partial Traffic 10-6
Exhibit 10-4 Examples of Construction 10-8
Exhibit 10-5 Temporary Traffic Control During Roundabout
Construction 10-10
Exhibit 10-6 Maintenance Vehicle Parking Pullout within
the Central Island 10-13
Exhibit 10-7 Example of Roundabout Plowed for Snow 10-14
Exhibit 10-8 Snow Accumulation in the Splitter Island 10-15
Exhibit 10-9 Example Maintenance Project Staging Plan 10-15

10.1 INTRODUCTION

This chapter focuses on issues related to the actual construction of a roundabout as well as issues related to ongoing maintenance.

10.2 PUBLIC EDUCATION

One of the most important aspects of planning a roundabout construction project is providing public education. The public needs to be notified and educated whenever there is a change in traffic patterns. It can be especially important for a roundabout because the first roundabout in a city or region will be new to many motorists. The public involvement techniques discussed in Chapter 3 can be applied during the construction period.

The following are some suggestions to help alleviate initial driver confusion:

- Hold public meetings prior to construction.
- Prepare news releases/handouts detailing what the motorist can expect before, during, and after construction.
- Install variable message signs before and during construction.
- Use travelers advisory radio immediately prior to and during construction to disseminate construction information and driving instructions.
- Use websites or other online social media to disseminate information on construction progress and on use of the roundabout.
- Install signing during and after construction warning of changed traffic patterns.

Exhibit 10-1 illustrates a roundabout brochure that was developed for the installation of a new multilane roundabout in Clackamas County, Oregon. This provides general information about roundabouts and provides all users instructions for navigating the new roundabout in their community.

Public education during construction is as important as the public education effort during the planning process.

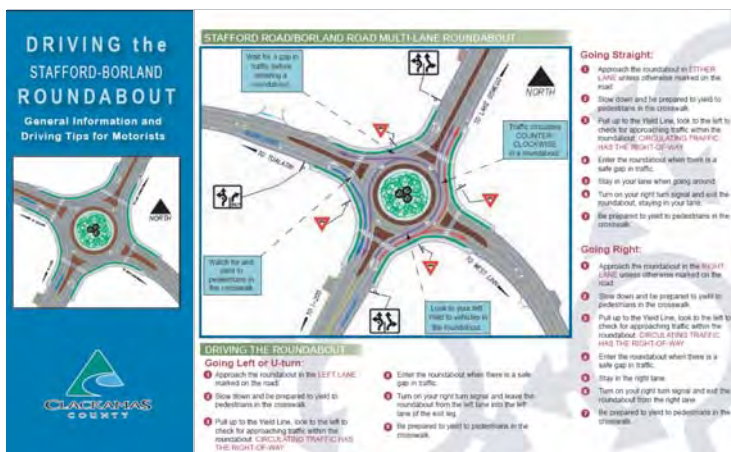

Clackamas County, Oregon

Exhibit 10-1
Example of Roundabout Informational Brochure

 Roundabouts: An Informational Guide

As part of the new roundabout installation in Clackamas County, a public information meeting was also held. Exhibit 10-2 provides two of the presentation boards that were used at the meeting to illustrate the proposed roundabout plan and expected project schedule.

Exhibit 10-2
Example of Public Meeting
Presentation Boards



Additional public education information and specific project examples are provided in Chapter 3.

10.3 CONSTRUCTION STAGING

Construction staging should be considered during the preliminary design of the roundabout, especially if it must be built under traffic.

Roundabouts can be constructed under three types of traffic conditions:

- With all traffic diverted away from the work area,
- With some traffic diverted, or
- Under full traffic.

The guiding principle is to minimize staging and to provide large sections of the project to construct during each construction stage. This will increase quality of construction, reduce driver confusion, reduce the construction time, and save construction costs. Generally, diverting or detouring as much traffic from the intersection as possible is the most desirable option. However, it is recognized that in many circumstances full (or even partial) detours are not feasible.

10.3.1 CONSTRUCTION UNDER NO TRAFFIC

It is highly desirable to construct a roundabout without traffic passing through the work zone. This will significantly reduce the construction time and cost and will increase the safety of the construction personnel. This is possible under two common scenarios: the roundabout is on a new roadway, or all traffic can be diverted away from the roundabout (even for a short period of time).

Anecdotal experience suggests that minimizing detour changes during construction is desirable to reduce public confusion through the time of construction. It is easier to communicate one or two different detours to the driving public through the course of a project versus constantly changing routes. Prior to detouring traffic, peripheral items (e.g., signing, illumination, and landscaping) outside the traveled way or with minimal effect on traffic can be completed to reduce the time the road is closed and the detour is in place.

10.3.2 CONSTRUCTION WITH SOME TRAFFIC DIVERTED

In some cases, if it is not possible to detour all of the traffic from the intersection, certain approaches may need to remain open to traffic. Construction under partial traffic commonly includes closing the minor roadway approaches, with the major street movements maintained either on the existing roadway or on temporary roadways implemented as part of the construction staging. The primary purpose of this technique is to eliminate intersection conflicts while still allowing some traffic to use the intersection.

Exhibit 10-3 provides a case study that illustrates an example of roundabout construction under partial traffic (1). The case study discusses construction staging at the Baldwin Road/Coats Road/Indianwood Road intersection in Oakland County, Michigan, where a single-lane roundabout was installed while maintaining traffic flow on the major roadway (Baldwin Road) through the use of temporary roadways. The majority of the roundabout construction occurred during Stage 2 due to the ability to close the minor approaches (Coats Road and Indianwood Road). Otherwise, the roundabout construction would have required additional staging, more complex traffic control, and an extended construction timeline.

Roundabouts: An Informational Guide

Exhibit 10-3
Example of Construction
under Partial Traffic

Baldwin Road/Coats Road/Indianwood Road

A single-lane roundabout was constructed at the intersection under partial traffic using four construction stages. Baldwin Road is the major roadway, which includes the west and south approaches of the intersection. The shaded portions of the plans represent the permanent pavement under construction, temporary pavement being placed for construction staging, or temporary pavement under traffic.

Stage I: Temporary Roadway Construction

- Construct a 12-ft (3.6-m) temporary roadway adjacent to the existing Baldwin Road for the east and south approaches of the intersection.
- Construct replacement culvert over the south approach.
- Maintain two-way traffic on the east, west, and north approaches.
- Maintain traffic on the south approach with partial lane closure controlled with flagging.

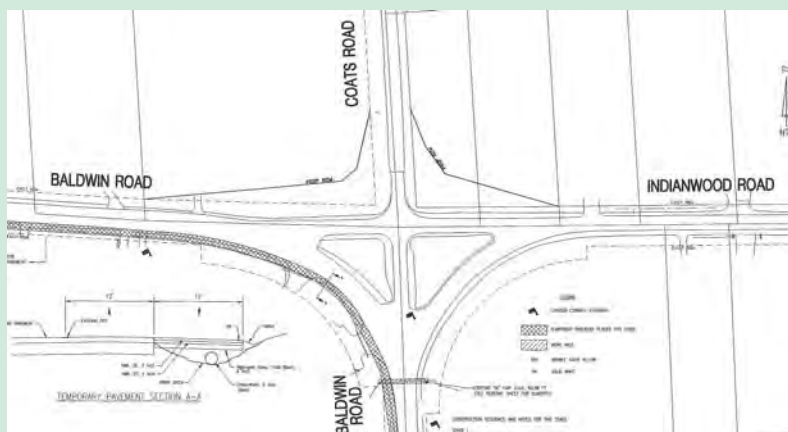

Stage II: Primary Roundabout Construction

- Close Coats Road and Indianwood Road to traffic.
- Shift traffic to temporary roadway on east and west approaches to maintain two-way traffic on Baldwin Road.
- Close southeast business driveway and restrict northwest business driveway to right-in/right-out only.
- Construct all roundabout improvements on the east and north approaches.
- Construct partial roundabout improvements on west and south approaches.
- Construct temporary pavement at the west and south approaches.

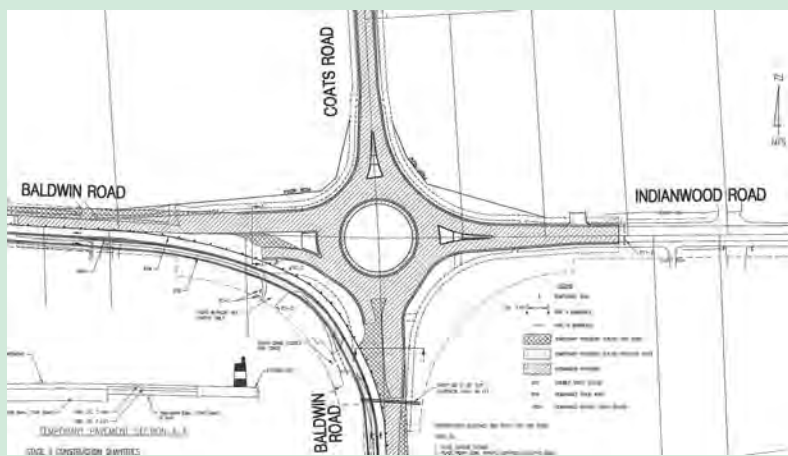

Stage III: West Approach Construction

- Complete roundabout improvements on west approach.
- Remove temporary pavement on south and west approaches.
- Shift traffic to temporary roadways on west approach to maintain two-way traffic on Baldwin Road.
- Close northwest business driveway and open southeast business driveway to right-in/right-out only movements.
- Install permanent signing on the north and east approaches and on the central island.
- Install signing and markings on the south and west approaches.
- Open Coats Road and Indianwood Road to traffic on permanent roadways.
- East, north, and south approaches operate as roundabout with two-way traffic.

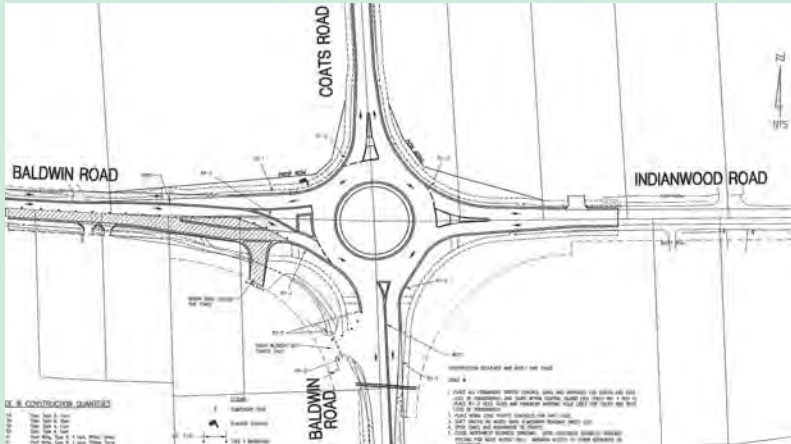

Stage IV: South Approach Construction

- Shift traffic to permanent roadway on west approach.
- Shift traffic to temporary roadway on south approach.
- Complete improvements on the south approach, including splitter island, completion of permanent roadway on the west side of the approach and removing temporary pavement.
- Complete improvements on the west approach, including splitter island and removing temporary pavement.
- Install remaining permanent signing and striping on all approaches.

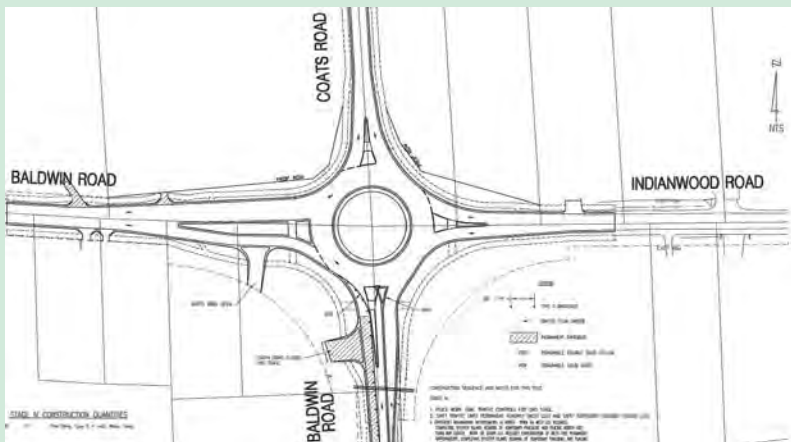

Exhibit 10-3 (cont.)
Example of Construction
under Partial Traffic

10.3.3 CONSTRUCTION UNDER FULL TRAFFIC

If it is not possible to detour all approaches, detour as many approaches as possible. This reduces the volume of traffic through the intersection and the number of turning movements available. However, when under full traffic, there are typically some intersection conflicts that should be carefully monitored and executed with the appropriate type of traffic control.

One possible sequence for staging construction under full traffic is as follows:

1. Install signing and lighting. (Signing should be initially covered.)
2. Construct outside widening if applicable.
3. Reconstruct or resurface approaches if applicable.
4. Construct splitter islands and delineate the central island. At this point the signs should be uncovered, and the intersection should operate as a roundabout. A recently completed splitter island is shown in Exhibit 10-4(a).
5. Finish construction of the central island.
6. Prepare final grade and apply final paving course for the circulating roadway and entry/exits. Grading of the circulatory roadway is shown in Exhibit 10-4(b).

Exhibit 10-4
Examples of Construction



(a) Splitter island construction (Portland, Oregon)



(b) Circulatory roadway sub-grade construction (Portland, Oregon)

Exhibit 10-4 (cont.)
Examples of Construction

Prior to the work that would change the traffic patterns to that of a roundabout, certain peripheral items may be completed. This would include permanent signing (covered), lighting, and some pavement markings. These items, if installed prior to the construction of the central island and splitter islands, would expedite the opening of the roundabout and provide additional safety during construction.

When work has commenced on the installation of the roundabout, it is desirable that it be completed as soon as possible to minimize the time the public is faced with an unfinished layout or where the traffic priority may not be obvious. If possible, all work, including the installation of splitter islands and striping, should be done before the roundabout is open to traffic.

If it is necessary to leave a roundabout in an uncompleted state overnight, the splitter islands should be constructed before the central island. Any portion of the roundabout that is not completed should be marked, delineated, and signed in such a way as to clearly outline the intended travel path. Pavement markings that do not conform to the intended travel path should be removed.

Other staging considerations are as follows:

- If projects must be constructed under traffic, night work is an option to reduce the impacts to traffic during peak hours.
- Flagging can be used on the approaches and exits to allow the contractors to work.
- Temporary signals can be used on the approaches under certain stages, if applicable.
- Temporary roadway construction may be necessary during certain stages of construction.
- The use of a temporary traffic pattern that is counter to normal roundabout operation (i.e., vehicles circulating clockwise instead of counterclockwise) is undesirable.

Roundabouts: An Informational Guide

Phasing should (to the extent possible) be aimed to train drivers in correct driving rules and habits once fully opened. This includes operating the intersection in a similar pattern to the final roundabout configuration. Exhibit 10-5 illustrates the use of cones and barrels to delineate the roundabout approaches and circulatory roadway while physical construction of the splitter island and central island is occurring.

Exhibit 10-5
Temporary Traffic Control
During Roundabout
Construction



Towson, Maryland

10.4 WORK ZONE TRAFFIC CONTROL

As is the case with any construction project, before any work can begin, all traffic control devices should be installed as indicated in the traffic control plan or recommended typical details. This traffic control should remain in place as long as it applies and then be removed when the message no longer applies to the condition.

During the construction of a roundabout it is essential that the intended travel path be clearly identified. This may be accomplished through pavement markings, signing, delineation, channelizing devices, and guidance from police and/or construction personnel, depending on the size and complexity of the roundabout. Care should be taken to minimize the channelizing devices so that motorists, bicyclists, and pedestrians have a clear indication of the required travel path. Each installation should be evaluated separately; a definitive guideline for the installation of roundabouts is beyond the scope of this guide. Refer to Part 6 of the MUTCD for requirements regarding work zone traffic control (2).

10.4.1 PAVEMENT MARKINGS

The pavement markings used in work zones should be the same layout and dimension as those used for the final installation. Because of the confusion of a work area and the change in traffic patterns, additional pavement markings may be used to clearly show the intended direction of travel. In some cases when pave-

ment markings cannot be placed, channelizing devices (i.e., cones, tubular markers, and/or drums) should be used to establish the travel path.

10.4.2 SIGNING

The signing in work zones should consist of all necessary signing for the efficient movement of traffic through the work area, pre-construction signing advising the public of the planned construction, and any regulatory and warning signs necessary for the movement of traffic outside of the immediate work area. The permanent roundabout signing should be installed where practical during the first construction stage so that it is available when the roundabout is operable. Permanent signing that cannot be installed initially should be placed on temporary supports in the proposed location until permanent installation can be completed.

10.4.3 LIGHTING

Temporary or permanent lighting, as described in Chapter 8, should be used to light the work area. A newly constructed or incomplete roundabout at night can be a surprise to drivers unless it is clearly visible when approaching the intersection. It is particularly important to provide lighting in construction areas for pedestrians and bicycles to ensure that drivers are aware of their presence and provide guidance for all users to navigate the intersection.

10.5 CONSTRUCTION PLANS

The requirements of every agency are different when it comes to construction plans and documents. However, plan sheets specifically important to roundabout construction are:

- Staging plan with detour routes (as appropriate),
- Staking plan with curve data (coordinates, radius),
- Paving plan and jointing plan (concrete pavement),
- Lighting plan,
- Signing plan, and
- Pavement marking plan.

Example construction plans can be found in the Kansas Department of Transportation's *Kansas Roundabout Guide* (3) and the Wisconsin Department of Transportation *Facilities Development Manual* (4).

10.6 CONSTRUCTION COORDINATION

As with all types of roadway construction projects, construction of a roundabout requires close coordination during the planning and implementation stages. The designer should remain engaged in the project through construction to ensure

that design details are properly executed and respond to contractor questions. The design and construction team should also coordinate closely with utilities to ensure that the existing equipment can be preserved, as needed, and new equipment can be integrated into the system. The following sections provide additional details regarding some of the coordination that should be considered during construction of a roundabout.

10.6.1 CONTRACTOR AND DESIGNER COORDINATION

Once a roundabout goes to construction it is important that any changes from the plan be discussed with the designer. Changes in lane widths, radii, grades, or other geometric parameters can affect safety and operational performance by impacting vehicle speeds, vehicle alignments, accommodation of trucks, and so forth.

For multilane roundabouts, it is particularly important that the engineer be notified and be on site to ensure that the contractor precisely lays the markings according to the plan. If the markings stray from the design, the roundabout may not operate as expected because the entering and receiving lanes need to line up appropriately and spiral markings should flow naturally. Similarly, where concrete pavement is used, the joint plans are an important design feature that must be carefully implemented by the contractor. Joint lines can be mistaken for lane lines and therefore it is important that additional joints or changes to the joint patterns be reviewed by the engineer.

Engineers should ensure that the contractor has a clear understanding of the design details for the truck apron. Contractors may build the truck apron flush to the circulatory roadway (which may lead to higher vehicle speeds) or may leave too much exposure on the face of the truck apron curb (which would discourage use by trucks or lead to truck load shifting). In either case, the accurate construction of the truck apron is important to achieving the intended intersection operations.

10.6.2 UTILITY COORDINATION

All roundabout construction should be closely coordinated with the local utility company. Existing utilities should be identified during the initial design stages of the roundabout to identify potential conflicts with utilities. This can be achieved through conducting a detailed field survey, reviewing existing intersection record drawings (as-built plans or as-constructed plans), and obtaining information from the utility company. If the roundabout construction will affect existing facilities, the utility company should be notified and integrated into the construction planning process to ensure proper relocation.

Installation of new equipment at the roundabout, such as illumination, conduit for future potential signalization, and drainage facilities should also be coordinated with the utility company to ensure that the new facilities can be adequately integrated into the existing system. Manhole placement should be included in the utility coordination. While the placement is specific to each site and may be dictated by the existing system, manholes should be located to allow

for safe access by maintenance crews and only minimal disruption to traffic at the roundabout.

10.7 MAINTENANCE

Maintenance of roundabouts is similar to that of any other intersection. A plan is necessary to carry out the maintenance operation, be it trimming the shrubs, snow removal, or routine pavement maintenance.

10.7.1 LANDSCAPING MAINTENANCE

As discussed in Chapter 9, choosing landscaping objects that require only periodic maintenance is preferred, particularly within the central island and splitter islands. One option for improving maintenance access to the central island is to provide an inset for a maintenance vehicle, as illustrated in Exhibit 10-6. This option is not necessary for most roundabouts, but may be desirable where more regular maintenance is required or where high traffic volumes may make it difficult or unsafe to access the central island.



Bend, Oregon

Exhibit 10-6
Maintenance Vehicle
Parking Pullout within the
Central Island

10.7.2 SNOW REMOVAL

Each agency in cold climates has its own technique and routine for plowing snow. For the first roundabout in a jurisdiction, it may be helpful to develop a plowing sequence plan until the plow operators become familiar and more efficient with plowing the roundabouts. Many jurisdictions have standard widths for snowplows within their fleet. In areas where snow removal is anticipated to be a regular occurrence, the geometric design of the roundabout may need to be tailored to accommodate the width of the plow blade. Some maintenance crews have noted that roundabouts make it easier to turn around snowplows as well. Exhibit 10-7 shows an example of a roundabout plowed for snow.

*Roundabouts: An Informational Guide***Exhibit 10-7**
Example of Roundabout
Plowed for Snow

Cle Elum, Washington

One common method for snow removal is for the snowplow to start on the innermost section of the circulatory roadway, often on the truck apron, and keep circulating while spiraling outward with each revolution clearing the snow from the circulatory roadway. At the same time, a second plow operator will clear the entries and exits, or the same plow operator will clear the approaches once the circulatory roadway is clear. The crown of the circulating roadway, if present, will also help dictate the plowing sequence of a roundabout.

One of the biggest pitfalls with plowing snow from the roundabout is identifying the location of the raised truck apron and other curb locations after heavy snowfall has occurred. Damage to the apron or to the curbs may occur if care is not taken by the operator in identifying the curb locations.

Snow storage should also be considered when plowing at a roundabout. Storage should not create a sight obstruction for drivers approaching or circulating the roundabout and should not affect pedestrian access through a roundabout. Exhibit 10-8 illustrates the limited sight-distance that can occur due to snow accumulation along the outside edge of the roundabout. Knocking down the height of the snow piles or removing snow from the islands may be necessary after prolonged periods of snowfall. It is also important that snow not be stored such that it will thaw and then freeze as ice on the circulatory roadway. Snow plowed from the roadway may contain road salts and other automobile waste that could impact vegetation if placed in sensitive landscaped areas.



View looking left from the entry (New York)

Exhibit 10-8
Snow Accumulation in the Splitter Island

10.7.3 PAVEMENT MAINTENANCE AND REHABILITATION

Pavement maintenance and rehabilitation projects are similar to new construction as far as construction staging. It is preferred that maintenance be conducted under as little traffic as possible; however, it can be done under traffic using the techniques described earlier in this chapter. Exhibit 10-9 provides an example of flagging operation for conducting maintenance work on one quadrant of an existing roundabout. The work was completed under full traffic with four flaggers (one at each approach) to guide traffic flow. In addition, it may be necessary to include another flagger on the central island to assist with movement through the roundabout.

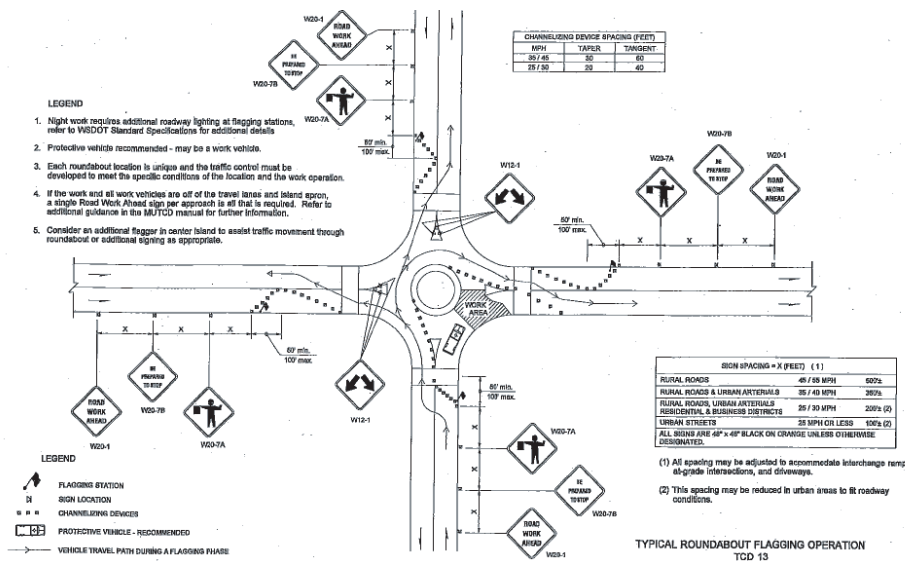

Exhibit 10-9
Example Maintenance Project Staging Plan

Source: Washington State Department of Transportation (5)

10.8 REFERENCES

1. Orchard Hiltz & McCliment, Inc., and Hampton Engineering Associates, Inc. "Staging Construction." Construction plans for Baldwin/Indianwood/Coats Road Roundabout, Oakland County, Michigan, 2003.
2. *Manual on Uniform Traffic Control Devices*. FHWA, Washington, D.C., 2003.
3. Kittelson & Associates, Inc., and TranSystems Corporation. *Kansas Roundabout Guide: A Supplement to FHWA's Roundabouts: An Informational Guide*. Kansas Department of Transportation, Topeka, Kansas, 2003.
4. Wisconsin Department of Transportation. *Facilities Development Manual*. <http://roadwaystandards.dot.wi.gov/standards/fdm/Forms/11-26-050p01.pdf>. Accessed March 2010.
5. Washington State Department of Transportation. Work Zone Traffic Control Plans. www.wsdot.wa.gov/Design/Standards/PlanSheet/WZ-1.htm. Accessed August 2009.

GLOSSARY

85th-percentile speed—a speed value obtained from a set of field-measured speeds where only 15% of the observed speeds are greater (source: HCM).

A

AADT—see **average annual daily traffic**.

AASHO—American Association of State Highway Officials. Predecessor to AASHTO.

AASHTO—American Association of State Highway and Transportation Officials.

accessible—describes a site, building, facility, or portion thereof that complies with the Americans with Disabilities Act Accessibility Guidelines (source: ADAAG).

accessible route—a continuous, unobstructed path connecting all accessible elements and spaces of a building or facility. Exterior accessible routes may include parking access aisles, curb ramps, crosswalks at vehicular ways, walks, ramps, and lifts (source: ADAAG).

accident—see **crash**.

ADA—Americans with Disabilities Act.

ADAAG—Americans with Disabilities Act Accessibility Guidelines.

all-way stop control—all approaches at the intersections have stop signs where all drivers must come to a complete stop. The decision to proceed is based in part of the rules of the road, which suggest that the driver on the right has the right-of-way, and also on the traffic conditions on the other approaches (source: HCM).

angle, entry—see **entry angle**.

approach—the portion of a roadway leading into a roundabout.

approach capacity—the capacity provided at the yield line during a specified period of time.

approach curvature—a series of progressively sharper curves used on an approach to slow traffic to a safe speed prior to reaching the yield line.

approach road half width—term used in the United Kingdom regression models. The approach half width is measured at a point in the approach upstream from any entry flare, from the median line or median curb to the nearside curb along a line perpendicular to the curb. See also **approach width**. (source: UK Geometric Design of Roundabouts)

approach speed—the posted or 85th-percentile speed on an approach prior to any geometric or signing treatments designed to slow speeds.

approach width—the width of the roadway used by approaching traffic upstream of any changes in width associated with the roundabout. The approach width is typically no more than half the total roadway width.

apron—the mountable portion of the central island adjacent to the circulatory roadway. Used in some roundabouts to accommodate the wheel tracking of large vehicles.

average annual daily traffic—the total volume passing a point or segment of a highway facility in both directions for one year divided by the number of days in the year (source: HCM).

average effective flare length—term used in the United Kingdom regression models. Defined by a geometric construct and is approximately equivalent to the length of flare that can be effectively used by vehicles. (source: UK Geometric Design of Roundabouts)

AWSC—see **all-way stop control**.

B

back of queue—the distance between the yield line of a roundabout and the farthest reach of an upstream queue, expressed as a number of vehicles. The vehicles previously stopped at the front of the queue may be moving (adapted from HCM).

benefit–cost analysis—a method of economic evaluation that uses the benefit–cost ratio as the measure of effectiveness.

benefit–cost ratio—the difference in benefits between an alternative and the no-build scenario, divided by the difference in costs between the alternative and the no-build scenario. See also **incremental benefit–cost ratio**.

bulb-out—see **curb extension**.

C

capacity—the maximum sustainable flow rate at which persons or vehicles can be reasonably expected to traverse a point or uniform segment of a lane or roadway during a specified time period under a given roadway and geometric, traffic, environmental, and control conditions. Usually expressed as vehicles per hour, passenger cars per hour, or persons per hour (source: HCM).

capacity, approach—see **approach capacity**.

capacity, roundabout—see **roundabout capacity**.

capital recovery factor—a factor that converts a present value cost into an annualized cost over a period of n years using an assumed discount rate of i percent.

central island—the raised area in the center of a roundabout around which traffic circulates.

CFR—Code of Federal Regulations.

channelization—the separation or regulation of conflicting traffic movements into definite paths of travel by traffic islands or pavement marking to facilitate the

safe and orderly movements of both vehicles and pedestrians (source: AASHTO Green Book).

circle, inscribed—see **inscribed circle**.

circular intersection—an intersection that vehicles traverse by circulating around a central island.

circulating flow rate—the total volume in a given period of time on the circulatory roadway immediately prior to an entrance, expressed as vehicles per hour.

circulating path radius—the minimum radius on the fastest through path around the central island.

circulating traffic—vehicles located on the circulatory roadway.

circulating volume—the total volume in a given period of time on the circulatory roadway immediately prior to an entrance.

circulatory roadway—the curved path used by vehicles to travel in a counter-clockwise fashion around the central island.

circulatory roadway width—the width between the outer edge of the circulatory roadway and the central island, not including the width of any apron.

circulating speed—the speed vehicles travel at while on the circulatory roadway.

conflict point—a location where the paths of two vehicles, or a vehicle and a bicycle or pedestrian, merge, diverge, cross, or queue behind each other.

conflict, crossing—see **crossing conflict**.

conflict, diverge—see **diverge conflict**.

conflict, merge—see **merge conflict**.

conflict, queuing—see **queuing conflict**.

conflicting flows—the two paths that merge, diverge, cross, or queue behind each other at a conflict point.

control delay—delay experienced by vehicles at an intersection due to movements at slower speeds and stops on approaches as vehicles move up in the queue.

crash—a collision between a vehicle and another vehicle, a pedestrian, a bicycle, or a fixed object.

crash frequency—the average number of crashes at a location per period of time.

crash rate—the number of crashes at a location or on a roadway segment, divided by the number of vehicles entering the location or by the length of the segment.

CRF—see **capital recovery factor**.

crossing conflict—the intersection of two traffic streams, including pedestrians. Crossing conflicts are the most severe type of conflict.

curb extension—the construction of curbing such that the width of a street is reduced. Often used to provide space for parking or a bus stop or to reduce pedestrian crossing distances.

curb ramp—a short ramp cutting through a curb or built up to it (source: ADAAG).

curvature, approach—see **approach curvature**.

D

D factor—the proportion of the two-way traffic assigned to the peak direction.

deflection—the change in trajectory of a vehicle imposed by geometric features of the roadway.

degree of saturation—see **volume-to-capacity ratio**.

delay—additional travel time experienced by a driver, passenger, or pedestrian beyond what would reasonably be desired for a given trip.

delay, control—see **control delay**.

delay, geometric—see **geometric delay**.

demand flow—the number of vehicles or persons that would like to use a roadway facility during a specified period of time.

departure width—the width of the roadway used by departing traffic downstream of any changes in width associated with the roundabout. The departure width is typically no more than half the total roadway width.

design user—any user (motorized or non-motorized) that can reasonably be anticipated to use a facility.

design vehicle—the largest vehicle that can reasonably be anticipated to use a facility.

detectable warning surface—a standardized surface feature built in or applied to walking surfaces or other elements to warn visually impaired people of hazards on a circulation path (source: ADAAG).

diameter, inscribed circle—see **inscribed circle diameter**.

distance, set-back—see **set-back distance**.

diverge conflict—the separation of two traffic streams, typically the least severe of all conflicts.

divisional island—see **splitter island**

double-lane roundabout—a roundabout that has at least one entry with two lanes, and a circulatory roadway that can accommodate more than one vehicle traveling side-by-side.

downstream—the direction toward which traffic is flowing (source: HCM).

E

entering traffic—vehicles located on a roundabout entrance.

entering volume—the total volume in a given period of time on an entrance to a roundabout.

entrance line—a pavement marking used to mark the point of entry from an approach into the circulatory roadway and generally marked along the inscribed circle. If necessary, entering traffic must yield to circulating traffic before crossing this line into the circulatory roadway.

entry angle—term used in the United Kingdom regression models. It serves as a geometric proxy for the conflict angle between entering and circulating streams and is determined through a geometric construct. (source: UK Geometric Design of Roundabouts)

entry flare—the widening of an approach to multiple lanes to provide additional capacity at the yield line and storage.

entry flow—see entering volume.

entry path curvature—term used in the United Kingdom to describe a measure of the amount of entry deflection to the right imposed on vehicles at the entry to a roundabout. (source: UK Geometric Design of Roundabouts)

entry path radius—the minimum radius on the fastest through path prior to the yield line.

entry radius—the minimum radius of curvature of the outside curb at the entry.

entry speed—the speed a vehicle is traveling at as it crosses the yield line.

entry width—the width of the entry where it meets the inscribed circle, measured perpendicularly from the right edge of the entry to the intersection point of the left edge line and the inscribed circle.

entry, perpendicular—see **perpendicular entry**.

exit path radius—the minimum radius on the fastest through path into the exit.

exit radius—the minimum radius of curvature of the outside curb at the exit.

exit width—the width of the exit where it meets the inscribed circle, measured perpendicularly from the right edge of the exit to the intersection point of the left edge line and the inscribed circle.

exiting traffic—vehicles departing a roundabout by a particular exit.

extended splitter island—see **splitter island, extended**.

F

FHWA—Federal Highway Administration.

flare—see **entry flare**.

flare, entry—see **entry flare**.

flow, circulating—see **circulating volume**.

flow, demand—see **demand flow**.

flow, entry—see **entering volume**.

flows, conflicting—see **conflicting flows**.

G

geometric delay—the delay caused by the alignment of the lane or the path taken by the vehicle on a roadway or through an intersection.

geometric design—a term used in this document to describe the design of horizontal and vertical alignment and cross-sectional elements of a roadway.

give way—term used in the United Kingdom and Australia for yield.

give way rule—rule adopted in the United Kingdom in November 1966 that required that all vehicles entering a roundabout give way, or yield, to circulating vehicles.

H

HCM—Highway Capacity Manual.

I

IES—Illuminating Engineers Society.

incremental benefit–cost ratio—the difference in benefits between two alternatives divided by the difference in costs between the two alternatives. See also **benefit–cost ratio**.

inscribed circle—the circle forming the outer edge of the circulatory roadway.

inscribed circle diameter—the basic parameter used to define the size of a roundabout, measured between the outer edges of the circulatory roadway. It is the diameter of the largest circle that can be inscribed within the outline of the intersection.

interchange—a grade-separated junction of two roadways where movement from one roadway to the other is provided for.

intersection—an at-grade junction of two or more roadways.

intersection sight distance—the distance required for a driver without the right-of-way to perceive and react to the presence of conflicting vehicles.

island, central—see **central island**.

island, median—see **splitter island**.

island, separator—see **splitter island**.

island, splitter—see **splitter island**.

ITE—Institute of Transportation Engineers.

K

KABCO—a severity scale used by the investigating police officer on the scene to classify injury severity for occupants with five categories: K, killed; A, disabling injury; B, evident injury; C, possible injury; O, no apparent injury. These definitions may vary slightly for different police agencies. (Source: National Safety Council, 1990)

K factor—the proportion of the AADT assigned to the design hour.

L

left-turn path radius—the minimum radius on the fastest path of the conflicting left-turn movement.

level of service—a qualitative measure describing operational conditions within a traffic stream, generally described in terms of service measures such as speed and travel time, freedom to maneuver, traffic interruptions, comfort, and convenience.

line, entrance—see **entrance line**.

line, yield—see **yield line**.

locking—stoppage of traffic on the circulatory roadway caused by queuing backing into the roundabout from one of the exits, resulting in traffic being unable to enter or circulate.

LOS—see **level of service**.

M

maximum service volume—the maximum hourly rate at which vehicles, bicycles, or persons can be reasonably expected to traverse a point or uniform section of a roadway during an hour under specific assumed conditions while maintaining a designated level of service. (source: HCM)

measures of effectiveness—a quantitative parameter whose value is an indicator of the performance of a transportation facility or service from the perspective of the users of the facility or service.

median island—see **splitter island**.

merge conflict—the joining of two traffic streams.

mini-roundabout—small roundabouts used in low-speed urban environments. The central island is fully mountable, and the splitter islands are either painted or mountable.

modern roundabout—a term used to distinguish newer circular intersections conforming to the characteristics of roundabouts from older-style rotaries and traffic circles.

mountable—used to describe geometric features that can be driven upon by vehicles without damage, but not intended to be in the normal path of traffic.

multilane roundabout—a roundabout that has at least one entry with two or more lanes, and a circulatory roadway that can accommodate more than one vehicle traveling side-by-side.

MUTCD—Manual on Uniform Traffic Control Devices.

N

NCUTCD—National Committee on Uniform Traffic Control Devices.

neighborhood traffic circle—a circular intersection constructed at the intersection of two local streets for traffic calming and/or aesthetic purposes. They are generally not channelized, may be uncontrolled or stop-controlled, and may allow left turns to occur left (clockwise) of the central island.

non-conforming traffic circle—see **traffic circle**.

non-traversable—see **raised**.

O

O&M costs—operations and maintenance costs.

P

peak hour factor—the hourly volume during the maximum volume hour of the day divided by the peak 15-minute flow rate within the peak hour; a measure of traffic demand fluctuation within the peak hour.

pedestrian refuge—an at-grade opening within a median island that allows pedestrians to safely wait for an acceptable gap in traffic.

perpendicular entry—an entry angle of 70 degrees or more.

PHF—see **peak hour factor**.

platoon—a group of vehicles or pedestrians traveling together as a group, either voluntarily or involuntarily because of signal control, geometrics, or other factors.

point, conflict—see **conflict point**.

priority—the assignment of right-of-way to a particular traffic stream or movement.

progression, signal—see **signal progression**.

Q

queue—a line of vehicles, bicycles, or persons waiting to be served by the system in which the flow rate from the front of the queue determines the average speed within the queue. Slowly moving vehicles or persons joining the rear of the queue are usually considered a part of the queue. The internal queue dynamics may involve a series of starts and stops. (source: HCM)

queuing conflict—a conflict that arises within a traffic stream between a lead vehicle and a following vehicle, when the lead vehicle must come to a stop.

R

radius, circulating path—see **circulating path radius**.

radius, entry—see **entry radius**.

radius, entry path—see **entry path radius**.

radius, exit—see **exit radius**.

radius, exit path—see **exit path radius**.

radius, left-turn path—see **left-turn path radius**.

radius, right-turn path—see **right-turn path radius**.

raised—used to describe geometric features with a sharp elevation change that are not intended to be driven upon by vehicles at any time.

ramp, wheelchair—see **curb ramp**.

refuge, pedestrian—see **pedestrian refuge**.

right-of-way—(1) an intersection user that has priority over other users.
(2) Land owned by a public agency for transportation uses.

right-turn bypass lane—a lane provided adjacent to, but separated from, the circulatory roadway, that allows right-turning movements to bypass the roundabout. Also known as a **right-turn slip lane**.

right-turn path radius—the minimum radius on the fastest path of a right-turning vehicle.

right-turn slip lane—see **right-turn bypass lane**.

roadway, circulatory—see **circulatory roadway**.

rotary—a term used particularly in the Eastern United States to describe an older-style circular intersection that does not have one or more of the characteristics of a roundabout. They often have large diameters, often in excess of 300 ft (100 m), allowing high travel speeds on the circulatory roadway. Also known as a **traffic circle**.

roundabout—an intersection with a generally circular shape, yield control of all entering traffic, and geometric curvature and features to induce desirable vehicular speeds.

roundabout capacity—the maximum number of entering vehicles that can be reasonably expected to be served by a roundabout during a specified period of time.

roundabout, modern—see **modern roundabout**.

roundabout, multilane—see **multilane roundabout**.

roundabout, single lane—see **single-lane roundabout**.

S

separator island—see **splitter island**.

service volume—the hourly rate at which vehicles, bicycles, or persons can be reasonably expected to traverse a point or uniform section of a roadway during an

hour under specific assumed conditions. See also **maximum service volume**.
(Adapted from HCM)

set-back distance—the distance between the edge of the circulatory roadway and the sidewalk.

sharpness of flare—a measure of the rate at which extra width is developed in the entry flare. (source: UK Geometric Design of Roundabouts)

sight distance, intersection—see **intersection sight distance**.

sight distance, stopping—see **stopping sight distance**.

sight triangle—an area required to be free of obstructions to enable visibility between conflicting movements.

signal progression—the use of coordinated traffic signals along a roadway in order to minimize stops and delay to through traffic on the major road.

single-lane roundabout—a roundabout that has single lanes on all entries and one circulatory lane.

speed table—an extended, flat-top road hump sometimes used at pedestrian crossings to slow traffic and to provide a better visual indication of the crosswalk location.

speed, approach—see **approach speed**.

speed, circulating—see **circulating speed**.

speed, entry—see **entry speed**.

splitter island—a raised or painted area on an approach used to separate entering from exiting traffic, deflect and slow entering traffic, and provide storage space for pedestrians crossing that intersection approach in two stages. Also known as a **median island** or a **separator island**.

splitter island, extended—a raised splitter island that begins some distance upstream of the pedestrian crossing to separate entering and exiting traffic. A design feature of rural single-lane roundabouts.

stopping sight distance—the distance along a roadway required for a driver to perceive and react to an object in the roadway and to brake to a complete stop before reaching that object.

T

traffic calming—geometric treatments used to slow traffic speeds or to discourage the use of a roadway by non-local traffic.

traffic circle—a circular intersection that does not have one or more of the characteristics of a roundabout. Also known as a **rotary**.

traffic circle, neighborhood—see **neighborhood traffic circle**.

traffic circle, non-conforming—see **traffic circle**.

traffic, circulating—see **circulating traffic**.

traffic, entering—see **entering traffic**.

truck apron—see **apron**.

two-stage crossing—a process in which pedestrians cross a roadway by crossing one direction of traffic at a time, waiting in a pedestrian refuge between the two traffic streams if necessary before completing the crossing.

two-way stop-control—stop signs are present on the approach(es) of the minor street, and drivers on the minor street or a driver turning left from the major street wait for a gap in the major street traffic to complete a maneuver.

TWSC—see **two-way stop control**.

U

U-turn—a turning movement at an intersection in which a vehicle departs the intersection using the same roadway it used to enter the intersection.

upstream—the direction from which traffic is flowing (source: HCM).

UVC—Uniform Vehicle Code.

V

vehicle, design—see **design vehicle**.

volume, circulating—see **circulating volume**.

volume, entering—see **entering volume**.

volume, service—see **service volume**.

volume-to-capacity ratio—the ratio of flow rate to capacity for a transportation facility.

W

wheelchair ramp—see **curb ramp**.

width, approach—see **approach width**.

width, circulatory roadway—see **circulatory roadway width**.

width, departure—see **departure width**.

width, entry—see **entry width**.

width, exit—see **exit width**.

Y

yield—an intersection control in which controlled traffic must stop only if higher priority traffic is present.

yield line—a pavement marking used to mark the point of yielding at a roundabout entry. See also **entrance line**.

Z

zebra crossing—a crossing marked by transverse white stripes where vehicles are required to yield to pedestrians.

BIBLIOGRAPHY

BOOKS, REPORTS, AND GUIDES

UNITED STATES

- AASHTO. *A Policy on Design of Urban Highways and Arterial Streets*. Washington, D.C.: AASHTO, 1973.
- AASHTO. *Guide for Development of Bicycle Facilities*. Washington, D.C.: AASHTO, 1991.
- AASHTO. *An Information Guide for Roadway Lighting*. Washington, D.C.: AASHTO, 1985.
- AASHTO. *A Manual on User Benefit Analysis of Highway and Bus Transit Improvements*. Washington, D.C.: AASHTO, 1977.
- AASHTO. *Standard Specifications for Structural Supports for Highway Signs, Luminaires and Traffic Signals*. Washington, D.C.: AASHTO, 1994.
- AASHTO. *A Policy on Geometric Design of Highways and Streets*. Washington, D.C.: AASHTO, 2004.
- AASHTO. *Roadside Design Guide*. Washington, D.C.: AASHTO, 2006.
- Americans with Disabilities Act Accessibility Guidelines for Buildings and Facilities*. 36 CFR Part 1191. <http://ada.gov/pubs/ada.htm>.
- Antonucci, N. D., K. K. Hardy, K. L. Slack, R. Pfefer, and T. R. Neuman. *NCHRP Report 500: Guidance for the Implementation of the AASHTO Strategic Highway Safety Plan. Volume 12: A Guide for Reducing Collisions at Signalized Intersections*. Washington, D.C.: Transportation Research Board of the National Academies, 2004.
- Baker, M. *Guide to Modern Roundabouts*, PENNDOT Publication Number 414, Pennsylvania Department of Transportation, May 2001.
- Bared, J. G. and K. Kennedy. "Safety Impacts of Modern Roundabouts." In *ITE Safety Toolbox*, Institute of Transportation Engineers, 1999.
- Bauer, K. M. and D. W. Harwood. *Statistical Models of At-Grade Intersection Crashes*. Report No FHWA-RD-99-094. Washington, D.C.: Federal Highway Administration, 1999.
- Brilon, W., R. Troutbeck, and M. Tracz. *Transportation Research Circular 468: Review of International Practices Used to Evaluate Unsignalized Intersections*. Washington, D.C.: TRB, National Research Council, April 1997.
- Carter, D., W. Hunter, C. Zegeer, J. Stewart, and H. Huang. *Pedestrian and Bicyclist Intersection Safety Indices: Research Report. Draft Final Report*. U.S. Department of Transportation, FHWA, February 2006.
- Duncan, G. *Paramics Technical Report: Car-Following, Lane-Changing and Junction Modelling*. Edinburgh, Scotland: Quadstone, Ltd., 1997.

- Fambro, D. B., K. Fitzpatrick, and R. J. Koppa. *NCHRP Report 400: Determination of Stopping Sight Distances*. Washington, D.C.: TRB, National Research Council, 1997.
- FHWA. "INFORMATION: Public Rights-of-Way Access Advisory." Letter from Frederick D. Isler, Associate Administrator for Civil Rights to Division Administrators, Resource Center Directors, and Federal Lands Highway Division Engineers. January 23, 2006. <http://www.fhwa.dot.gov/environment/bikeped/prwaa.htm>. Accessed January 19, 2009.
- FHWA. *Manual on Uniform Traffic Control Devices*. Washington, D.C.: FHWA, 2003.
- FHWA. Notice of Proposed Amendments for the Manual on Uniform Traffic Control Devices. FHWA, Washington, D.C., December 2007.
- FHWA. *Older Driver Highway Design Handbook*. Publication No. FHWA-RD-97-135. Washington, D.C.: FHWA, January 1998.
- FHWA. *Railroad-Highway Grade Crossing Handbook*, 2nd ed. Publication No. FHWA-SA-07-010. Washington, D.C.: FHWA, August 2007.
- FHWA. *SafetyAnalyst*. <http://www.safetyanalyst.org/>. Accessed August 2009.
- FHWA. *Standard Highway Signs*. Washington, D.C.: FHWA, 2004.
- FHWA. *Traffic Analysis Toolbox*. <http://ops.fhwa.dot.gov/trafficanalysistools/index.htm>. Accessed August 2009.
- FHWA. *Traffic Maneuver Problems of Older Drivers: Final Technical Report*. Publication No. FHWA-RD-92-092. Washington, D.C.: FHWA, 1993.
- Fitzpatrick, K., S. Turner, M. Brewer, P. Carlson, B. Ullman, N. Trout, E. S. Park, J. Whitacre, N. Lalani, and D. Lord. *TCRP Report 112/NCHRP Report 562: Improving Pedestrian Safety at Unsignalized Crossings*, Washington, D.C.: Transportation Research Board of the National Academies, 2006.
- Florida Department of Transportation. *Florida Roundabout Guide*. Florida Department of Transportation, March 1996.
- Garder, P. *The Modern Roundabouts: The Sensible Alternative for Maine*. Maine Department of Transportation, Bureau of Planning, Research and Community Services, Transportation Research Division, 1998.
- Glauz, W. D. and D. J. Migletz. *NCHRP Report 219: Application of Traffic Conflict Analysis at Intersections*. Washington, D.C.: TRB, National Research Council, 1980.
- Harwood, D. W., J. M. Mason, R. E. Brydia, M. T. Pietrucha, and G. L. Gittings. *NCHRP Report 383: Intersection Sight Distances*. Washington, D.C.: TRB, National Research Council, 1996.
- IES. *American National Standard Practice for Roadway Lighting*. Standard RP-8. December 1982.
- Innovative Transportation Concepts, LLC. *VISSIM: User Manual*. Program Version 2.32–2.36. November 10, 1997.

- Institute of Transportation Engineers. *Transportation Planning Handbook*, 3rd ed. Washington, D.C.: ITE, 2009.
- Institute of Transportation Engineers. *Enhancing Intersection Safety through Roundabouts: An ITE Informational Report*. Washington, D.C.: ITE, 2008.
- Institute of Transportation Engineers. *Manual of Transportation Engineering Studies*. (H. D. Robertson, J. E. Hummer, and D. C. Nelson, eds.). Englewood Cliffs, N.J.: Prentice-Hall, 2000.
- Institute of Transportation Engineers. *Use of Roundabouts*. Prepared by ITE Technical Council Committee 5B-17, February 1992.
- Jacquemart, G. *NCHRP Synthesis of Highway Practice 264: Modern Roundabout Practice in the United States*. Washington, D.C.: TRB, National Research Council, 1998.
- Joerger, M. *Adjustment of Driver Behavior to an Urban Multi-Lane Roundabout*. Final Report SPR 041. Oregon Department of Transportation and Federal Highway Administration, 2007.
- Kittelson & Associates, Inc., and TranSystems Corporation. *Kansas Roundabout Guide: A Supplement to FHWA's Roundabouts: An Informational Guide*. Topeka, Kansas: Kansas Department of Transportation, October 2003.
- Krammes, R., et al. *Horizontal Alignment Design Consistency for Rural Two-Lane Highways*. Publication No. FHWA-RD-94-034. Washington, D.C.: FHWA, January 1995.
- Leaf, W. A. and D. F. Preusser. *Literature Review on Vehicle Travel Speeds and Pedestrian Injuries*. Final Report DOT HS 809 021. Washington, D.C.: National Highway Traffic Safety Administration, Department of Transportation, October 1999.
- Lee, J., B. Kidd, B. Robinson, and W. Scarbrough. *Roundabouts: An Arizona Case Study and Design Guidelines. Final Report 545*. Arizona Department of Transportation. Phoenix, Arizona. July 2003.
- Lord, D., I. van Schalkwyk, L. Staplin, and S. Chrysler. *Reducing Older Driver Injuries at Intersections Using More Accommodating Roundabout Design Practices*. College Station, Texas: Texas Transportation Institute, 2005.
- Mandavilli, S., A. McCartt, and R. Retting. *Crash Patterns and Potential Engineering Countermeasures at Maryland Roundabouts*. Arlington, Virginia: Insurance Institute for Highway Safety, May 2008.
- Maryland Department of Transportation. *Maryland's Roundabouts: Accident Experience and Economic Evaluation*. Office of Traffic and Safety, State Highway Administration, Maryland Department of Transportation, 2007.
- Maryland Department of Transportation. *Roundabout Design Guidelines*. State of Maryland Department of Transportation, State Highway Administration, 1995.
- Matthias, J., M. De Nicholas, and G. Thomas. *A Study of the Relationship between Left-Turn Accidents and Driver Age in Arizona*. Report No. AZ-SP-9603. Arizona Department of Transportation, Phoenix, Arizona, 1996.

- Migletz, D. J., W. D. Glauz, and K. M. Bauer. *Relationships between Traffic Conflicts and Crashes*. Report No. FHWA-RD-84-042. Washington, D.C.: FHWA, 1985.
- Minnesota Department of Transportation. *Minnesota State Aid Roundabout Guide. Technical Memorandum 02-SA-02*. St. Paul, Minnesota, August 30, 2002.
- National Committee on Uniform Traffic Laws and Ordinances (NCUTLO). *Uniform Vehicle Code and Model Traffic Ordinance*. Evanston, Illinois: NCUTLO, 1992.
- National Safety Council. *Average Comprehensive Cost by Injury Severity, 2007*. <http://www.nsc.org/resources/issues/estcost.aspx>. Accessed March 2009.
- Neuman, T. R., R. Pfefer, K. L. Slack, K. K. Hardy, D. W. Harwood, I. B. Potts, D. J. Torbic, and E. R. K. Rabbani. *NCHRP Report 500: Guidance for the Implementation of the AASHTO Strategic Highway Safety Plan. Volume 5: A Guide for Addressing Unsignalized Intersection Collisions*. Washington, D.C.: Transportation Research Board of the National Academies, 2003.
- New York State Department of Transportation. *Highway Design Manual*, Chapter 5, Basic Design, Section 5.9—Intersections at Grade, page 5-95. August 23, 2006. <https://www.nysdot.gov/portal/page/portal/divisions/engineering/design/dqab/hdm>. Accessed May 2007.
- New York State Department of Transportation. *Roundabouts: Interim Requirements and Guidance*. Albany, NY. June 30, 2000.
- Ourston & Doctors, Inc. *Designs of Modern American Roundabouts*. 1996.
- Ourston & Doctors, Inc. *Roundabout Design Guidelines*. 1995.
- Pein, W. E. *Trail Intersection Design Guidelines*. Prepared for State Bicycle/Pedestrian Program, State Safety Office, Florida Department of Transportation. Highway Safety Research Center, University of North Carolina. September 1996.
- Prince George's County, Maryland. *Neighborhood Traffic Management Program*. Prince George's County (Maryland), Department of Public Works and Transportation, November 1995.
- Rodegerdts, L., M. Blogg, E. Wemple, E. Myers, M. Kyte, M. Dixon, G. List, A. Flannery, R. Troutbeck, W. Brilon, N. Wu, B. Persaud, C. Lyon, D. Harkey, and D. Carter. *NCHRP Report 572: Roundabouts in the United States*. Washington, D.C.: Transportation Research Board of the National Academies, 2007.
- Russell, E., S. Mandavilli, and M. Rys. *Operational Performance of Kansas Roundabouts: Phase II*. Report No. K-TRAN: KSU-02-4. Topeka, Kansas: Kansas Department of Transportation, 2005.
- Staplin, L., K. Lococo, S. Byington, and D. Harkey. *Highway Design Handbook for Older Drivers and Pedestrians*. Report No. FHWA-RD-01-103. Washington, D.C.: FHWA, 2001.
- Stutts, J. *Improving the Safety of Older Road Users*. NCHRP Synthesis 378. Washington, D.C.: Transportation Research Board of the National Academies, 2005.

- Tian, Z. Z., F. Xu, L. A. Rodegerdts, W. E. Scarbrough, B. L. Ray, W. E. Bishop, T. C. Ferrara, and S. Mam. *Roundabout Geometric Design Guidance*. Report No. F/CA/RI-2006/13, Division of Research and Innovation, California Department of Transportation, Sacramento, Calif., June 2007.
- Transportation Research Board. *Highway Capacity Manual 2000*. Washington, D.C.: TRB, National Research Council, 2000.
- Transportation Research Board. *2010 Highway Capacity Manual*. Washington, D.C.: Transportation Research Board of the National Academies. Forthcoming.
- United States Access Board. *Draft Guidelines for Accessible Public Rights-of-Way*. Washington, D.C.: U.S. Architectural and Transportation Barriers Compliance Board, 2005.
- United States Access Board. *Building a True Community: Report of the Public Rights-of-Way Access Advisory Committee*. Washington, D.C.: U.S. Architectural and Transportation Barriers Compliance Board, 2001.
- United States Access Board. *Americans with Disabilities Act Accessibility Guidelines*. <http://www.access-board.gov/adaag/html/adaag.htm>.
- Washington Department of Transportation. *Design Manual*. Chapter 915. Olympia, WA: Washington Department of Transportation, May 2004, pp. 915-1 to 915-29.
- Wisconsin Department of Transportation. *Facilities Development Manual*. 2009.
- Wisconsin Department of Transportation. *Facilities Development Manual*, Chapter 11—Design, Section 11-26-1, Page 5. July 29, 2004. <http://roadwaystandards.dot.wi.gov/standards/fdm/main/fdm2006pg2.htm>. Accessed May 2007.
- Wisconsin Department of Transportation. *Roundabout Guide*. April 2008.
- Zegeer, C. V., J. Stutts, H. Huang, M. J. Cynecki, R. van Houten, B. Alberson, R. Pfefer, T. R. Neuman, K. L. Slack, and K. K. Hardy. *NCHRP Report 500: Guidance for the Implementation of the AASHTO Strategic Highway Safety Plan. Volume 10: A Guide for Reducing Collisions Involving Pedestrians*. Washington, D.C.: Transportation Research Board of the National Academies, 2004.

AUSTRALIA/NEW ZEALAND

- Akçelik, R. and M. Besley. *SIDRA 5 User Guide*. Melbourne, Australia: Australian Road Research Board Transport Research Ltd., January 1999.
- Australia. *Traffic Act*, Part 6A, 1962.
- Australia/New Zealand Standard. Road lighting. Part 1.3: Vehicular traffic (Category V) lighting—Guide to design, installation, operation and maintenance. Report no. AS/NZS 1158.1.3:1997. Published jointly by Homebush, New South Wales (Australia): Standards Australia and Wellington (New Zealand): Standards New Zealand. 1997.

Austroroads. *Guide to Traffic Engineering Practice, Part 6: Roundabouts*. Sydney, Australia, 1993.

National Association of Australian State Road Authorities. *Roundabouts: A Design Guide*. National Association of Australian State Road Authorities, 1986.

Queensland Department of Main Roads (QDMR). "Chapter 14: Roundabouts." *Queensland Road Planning and Design Manual*. Queensland, Australia: QDMR, January 2006.

Queensland Department of Main Roads (QDMR). *Relationships between Roundabout Geometry and Accident Rates*. Queensland, Australia: Infrastructure Design of the Technology Division of QDMR, April 1998.

Roads and Traffic Authority (RTA), New South Wales (Australia). *Roundabouts: Geometric Design Method*. January 1997.

Troutbeck, R. J. *Evaluating the Performance of a Roundabout*. SR 45. Australian Road Research Board, August 1989.

Turner, S., A. Roozenburg, and T. Francis. *Predicting Accident Rates for Cyclists and Pedestrians*. Land Transport NZ Research Report 289. Wellington, NZ: Land Transport NZ, 2006.

VicRoads. *Victorian Traffic Handbook*, 4th ed. Melbourne, Australia: Roads Corporation, 1998.

CANADA

Quebec Ministere des Transports. *Roundabouts: A Different Type of Management Approach*. 2005.

Transportation Association of Canada. *Guide for the Design of Roadway Lighting*. Ottawa, Ontario, Canada: Transportation Association of Canada, 2006.

Transportation Association of Canada. *Synthesis of North American Roundabout Practice*. Ottawa, Ontario, Canada: Transportation Association of Canada, December 2008.

GERMANY

Brilon, W., B. Stuwe, and O. Drews. *Sicherheit und Leistungsfähigkeit von Kreisverkehrsplätzen (Safety and Capacity of Roundabouts)*. Research Report. Ruhr-University Bochum, 1993.

Department of Transport of Northrhine-Westfalia, Germany. *Empfehlungen zum Einsatz und zur Gestaltung von Mini-Kreisverkehrsplaetzen (Guidelines for the Use and Design of Mini-Roundabouts)*. Dusseldorf, Germany, 1999.

Empfehlungen zum Einsatz und zur Gestaltung kleiner Kreisverkehrsplatze, Freistaat Sachsen Einsatz-Und Gestaltung von Kreisverkehrsplatzen an Bunderstrassen Ausserhalb Bebauter Gebiete. Brilon, W. and L. Bondzio, Ruhr-Universitat Bochum (June 1995)

Haller, et al. Merkblatt für die Anlage von kleinen Kreisverkehrsplätzen (Guideline for the Construction of Small Roundabouts). Cologne, Germany: Forschungsgesellschaft für Straßen- und Verkehrswesen. V., August 1998.

Small Roundabouts: Recommendations for Application and Design, Nordrhein-Westfalen Department of City Development and Traffic (MSV), prepared by Werner Brilon, Ruhr-University Bochum; translated from German by Daniel J. Parrish, 1993.

FRANCE

Acts Du Seminaire: "Giratoires 92." Sétra, CETUR

Service d'Études Techniques des Routes et Autoroutes (Sétra—Center for Technical Studies of Roads and Highways). *Aménagement des Carrefours Interurbains sur les Routes Principales (Design of Rural Intersections on Major Roads)*. Bagnaux, France: Ministry of Transport and Housing, December, 1998.

Service d'Études Techniques des Routes et Autoroutes (Sétra—Center for Technical Studies of Roads and Highways). Safety with the Level Crossings: Case of the Proximity of a Roundabout. Bagnaux, France. (Translation 2007).

Centre d'Études sur les Réseaux les Transports, l'Urbanisme et les constructions publiques (CERTU). *L'Éclairage des Carrefours à Sens Giratoire (The Illumination of Roundabout Intersections)*. Lyon, France: CERTU, 1991.

Centre d'Études sur les Réseaux les Transports, l'Urbanisme et les constructions publiques (CERTU). *Carrefours Urbains (Urban Intersections) Guide*. Lyon, France: CERTU, January 1999.

THE NETHERLANDS

CROW. *Eenheid in rotondes (Uniformity in roundabouts)*. Publication 126. Ede, Netherlands: CROW, March 1998.

Centrum voor Regelgeving en Onderzoek in de Grond-, Water- en Wegenbouw en de Verkeerstechniek (CROW). *Rotondes (Roundabouts)*. Ede, Netherlands: CROW. December, 1993.

Schoon, C. C. and J. van Minnen. Accidents on Roundabouts: II. Second study into the road hazard presented by roundabouts, particularly with regard to cyclists and moped riders. R-93-16. Netherlands: SWOV Institute for Road Safety Research, 1993.

SPAIN

Ministerio de Fomento. *Recomendaciones sobre glorietas (Recommendations on Roundabouts)*. Ministerio de Fomento, Dirección General de Carreteras, 1996.

UNITED KINGDOM

- Binning, J. C. *ARCADY 6 (International) User Guide*. Application Guide AG 50. Crowthorne: TRL Limited. 2004.
- Brown, M. *TRL State of the Art Review: The Design of Roundabouts*. London: HMSO, 1995.
- Department for Transport. "TD 54/07, Design of Mini-Roundabouts." *Design Manual for Roads and Bridges*, Volume 6, Road Geometry; Section 2, Junctions, Part 2. Department for Transport, United Kingdom, August 2007.
- Department for Transport. *Geometric Design of Roundabouts*. TD 16/07. August 2007.
- Department for Transport. *Traffic Signs Manual*. Chapter 7: The Design of Traffic Signs. U.K. Department for Transport. 2003.
- Department for Transport. *The Highway Code*. Department of Transport and the Central Office of Information for Her Majesty's Stationery Office, 1996.
- Department for Transport and the County Surveyors Society. *Mini Roundabouts, Good Practice Guidance*. Department for Transport, United Kingdom, November 27, 2006. <http://www.dft.gov.uk/pgr/roads/tss/gpg/miniroundaboutsgoodpractice.pdf>. Accessed July 23, 2009.
- Kimber, R. M. *The Traffic Capacity of Roundabouts*. TRRL Laboratory Report LR 942. Crowthorne, England: Transport and Road Research Laboratory, 1980.
- Kimber, R. M. and E. M. Hollis. *Traffic Queues and Delays at Road Junctions*. TRRL Laboratory Report LR 909. Crowthorne, England: Transport and Road Research Laboratory, 1979.
- Lawton, B. J., P. J. Webb, G. T. Wall, and D. G. Davies. *Cyclists at "Continental" Style Roundabouts: Report on Four Trial Sites*. TRL Report TRL584. Crowthorne, England: TRL Limited. 2003.
- Maycock, G. and R. D. Hall *Crashes at Four-Arm Roundabouts*. TRRL Laboratory Report LR 1120. Crowthorne, England: Transport and Road Research Laboratory, 1984
- Sawers, C. *Mini-Roundabouts: A Definitive Guide for Small and Mini-Roundabouts (Right Hand Drive Version)*. Moor Value Ltd. (UK), 2007.
- Sawers, C. *Mini-Roundabouts: Getting Them Right!* Canterbury, Kent, United Kingdom: Euro-Marketing Communications, 1996.

ARTICLES, PROCEEDINGS, AND WEBSITES

- Abelard, P. Roundabout Art of Les Landes. http://www.abelard.org/france/les_landes_roundabout_art.php#roundabouts. Accessed September 2008.

- Akçelik, R., "Lane-by-Lane Modeling of Unequal Lane Use and Flares at Roundabouts and Signalized Intersection: The Sidra Solution," *Traffic Engineering & Control*, Vol. 38, No. 7/8, July / August 1997.
- Akçelik, R. and R. J. Troutbeck. "Implementation of the Australian Roundabout Analysis Method in SIDRA." In *Highway Capacity and Level of Service: Proceedings of the International Symposium on Highway Capacity* (U. Brannolte, ed.), Karlsruhe, Germany: Balkema Publisher, 1991, pp. 17–34.
- Akçelik, R., E. Chung, and M. Besley. "Getting around Better." *PC-Trans*, winter quarter 1997, pp. 14–19.
- Akçelik, R., E. Chung, and M. Besley. "Performance of Roundabouts under Heavy Demand Conditions." *Road & Transport Research*, Vol. 5, No. 2, June 1996, pp. 36–50.
- Alphand, F., U. Noelle, and B. Guichet. "Evolution of Design Rules for Urban Roundabouts in France." In *Intersections without Traffic Signals II*, Springer-Verlag, W. Brilon, ed., 1991, pp. 126–140.
- Alphand, F., U. Noelle, and B. Guichet. "Roundabouts and Road Safety: State of the Art in France." In *Intersections without Traffic Signals II*, Springer-Verlag, W. Brilon, ed., 1991, pp. 107–125.
- van Arem, B. "Capacities and Delays at Roundabouts in the Netherlands." Proceedings of Seminar H Held at the PTRC Transport, Highways and Planning Summer Annual Meeting, University of Manchester Institute of Science and Technology, England, from 14–18 September 1992, pp. 257–267.
- Armitage, D. J. and M. McDonald. "Roundabout Capacity." *Traffic Engineering & Control*, October 1974.
- Arndt, O. "Road Design Incorporating Three Fundamental Safety Parameters," *Technology Transfer Forum 5 & 6*, Transport Technology Division, Main Roads Department, Queensland, Australia, August 1998.
- Ashmead, D., D. Guth, R. Wall, R. Long, and P. Ponchillia. "Street Crossing by Sighted and Blind Pedestrians at a Modern Roundabout." *ASCE Journal of Transportation Engineering*, Vol. 131, 2005, p. 812.
- Avent, A. M. and R. A. Taylor. "Roundabouts: Aspects of their Design and Operations." *Queensland Division Technical Papers*, Vol. 20, No. 17, 1979, pp. 1–10.
- Bared, J. G. and P. K. Edara. "Simulated Capacity of Roundabouts and Impacts of the Roundabouts within a Progressed Signalized Road." *National Roundabout Conference: 2005 Proceedings*, Washington, D.C.: Transportation Research Board of the National Academies, May 2005.
- Bared, J. G., W. Prosser, and C. T. Essee. "State-of-the-Art Design of Roundabouts," In *Transportation Research Record 1579*. Washington, D.C.: TRB, National Research Council, 1997.
- Barnet, B. F. and city of Springfield, Oregon. "Anatomy of Education and Outreach to Inform Elected Officials, Community Leaders, and Citizens." Poster

- from Transportation Research Board National Roundabout Conference, Kansas City, Missouri, 2008.
- Bentzen, B., J. Barlow, and L. Franck. "Addressing Barriers to Blind Pedestrians at Signalized Intersections," *ITE Journal*, Vol. 70, No. 9, September 2000.
- Bergh, T., "Intersections without Traffic Signals: Swedish Experience on Capacity and Traffic Safety," *Intersections without Traffic Signals II*, Springer-Verlag, W. Brilon, ed., 1991, pp. 192–213
- Brilon, W. "Traffic Engineering and the New German Highway Capacity Manual." *Transportation Research A*, Vol. 28A, No. 6, 1994, pp. 469–481.
- Brilon, W. and L. Bondzio. *Untersuchung von Mini-Kreisverkehrsplaetzen (Investigation of Mini-Roundabouts)*. Ruhr-University Bochum, Germany, 1999.
- Brilon, W. and L. Bondzio. *White Paper: Summary of International Statistics on Roundabout Safety* (unpublished), July 1998.
- Brilon, W., M. Grossmann, and B. Stuwe. "Toward a New German Guideline for Capacity of Unsignalized Intersections," *Transportation Research Record 1320*. Washington, D.C.: TRB, National Research Council, 1991, pp. 168–174.
- Brilon, W. and B. Stuwe. "Capacity and Design of Traffic Circles in Germany." In *Transportation Research Record 1398*. Washington, D.C.: TRB, National Research Council, 1993.
- Brilon, W. and B. Stuwe. "Capacity and Safety of Roundabouts in West Germany." *Proceedings 15th ARRB Conference*, Vol. 15, Part 5, 1990, pp. 275–281.
- Brilon, W. and M. Vandehey. "Roundabouts: The State of the Art in Germany." In *ITE Journal*, November 1998.
- Brilon, W., N. Wu, and L. Bondzio. "Unsignalized Intersections in Germany—A State of the Art 1997." In *Proceedings of the Third International Symposium on Intersections without Traffic Signals*, M. Kyte, ed., Moscow, Idaho: University of Idaho, 1997.
- Brude, U. and J. Larsson. *What Roundabout Design Provides the Highest Possible Safety from a Traffic Safety Point of View?* Swedish National Road and Transport Research Institute (VTI). *Nordic Road and Transport Research*, No. 2, 2000.
- Brude, U. and J. Larsson. *The Safety of Cyclists at Roundabouts: A Comparison between Swedish, Danish and Dutch Results*. Swedish National Road and Transport Research Institute (VTI), *Nordic Road & Transport Research*, No. 1, 1997.
- Cassidy, M. J., M. Samer, M.-H. Wang, and F. Yang. "Unsignalized Intersection Capacity and Level of Service: Revisiting Critical Gap," *Transportation Research Record 1484*, Washington, D.C.: TRB, National Research Council, 1995, pp. 16–23.
- Cedersund, H. A. "Traffic Safety at Roundabouts." *Intersections without Traffic Signals I*, Springer-Verlag, W. Brilon, ed., 1991, pp. 305–318.

- Center for Research and Standardization in Civil Engineering. *Sign Up for the Bike: Design Manual for a Cycle-Friendly Infrastructure*. Netherlands: Center for Research and Standardization in Civil Engineering (CROW), 1993.
- Centre d'Etude des Transports Urbains (CETUR). "Safety of Roundabouts in Urban and Suburban Areas." Paris, 1992.
- Chandraratna, S., L. Mitchell, and N. Stamatiadis. *Evaluation of the Transportation Safety Needs of Older Drivers*. Lexington, Kentucky: Department of Civil Engineering, University of Kentucky, 2002.
- Chang, S. H. "Overcoming Unbalanced Flow Problems at a Roundabouts by Use of Part-Time Metering Signals." Master's Thesis of Monash University (January 1994).
- Chapman, J. and R. Benekohal. *Roundabout Warrants: Proposed Framework for Future Development*. *Transportation Research Record: Journal of the Transportation Research Board*, No. 1801. Washington, D.C.: Transportation Research Board of the National Academies, 2002, pp 39–45.
- Chin, H. C. "SIMRO: A Model to Simulate Traffic at Roundabouts." *Traffic Engineering & Controls*.
- Chung, E. "Comparison of Roundabout Capacity and Delay Estimates from Analytical and Simulation Models." *Proceedings 16th ARRB Conference*, Vol. 16, Part 5, 1992.
- Council, F., E. Zaloshnja, T. Miller, and B. Persaud. *Crash Cost Estimates by Maximum Police-Reported Injury Severity within Selected Crash Geometries*. Report No. FHWA-HRT-05-051. Washington, D.C.: FHWA, October 2005.
- Courage, K. G. "Roundabout Modeling in CORSIM." The Third International Symposium on Intersections without Traffic Signals, July 21–23, 1997, Portland, Oregon, USA.
- Crown, B. *An Introduction to Some Basic Principles of U.K. Roundabout Design*. Presented at the ITE District 6 Conference on Roundabouts, Loveland, Colorado, October 1998.
- Department of Transport (United Kingdom). "Killing Speed and Saving Lives." As reported in Oregon Department of Transportation, *Oregon Bicycle and Pedestrian Plan*, 1995.
- Department of Transport, "Determination of Size of Roundabouts at Major/Minor Junctions," Departmental Advice Note TA 23/81, 1981.
- Dinwoodie, J. "Surveying Traffic Delays at a Roundabout near Plymouth," *Mathematics in Transport Planning and Control*, J. D. Criffiths, ed., 1992, pp. 227–286.
- Dixon, M., A. Abdel-Rahim, M. Kyte, P. Rust, H. Cooley, and L. Rodegerdts. "Field Evaluation of Roundabout Turning Movement Estimation Procedures." *ASCE Journal of Transportation Engineering*, Vol. 133, 2007, p. 138.
- Drakopoulos, A. and R. W. Lyles. "Driver Age as a Factor in Comprehension of Left-Turn Signals." *Transportation Research Record 1573*. Washington, D.C.: TRB, National Research Council, 1997, pp. 76–85.

- Easa, S. and A. Mehmood. "Optimizing Geometric Design of Single-lane Roundabouts: Consistency Analysis." *Canadian Journal of Civil Engineering*, Vol. 31, 2004, pp. 1024–1038.
- Eisenman, S., J. Josselyn, and G. List. Findings from a Survey of Roundabouts in the United States. Presented at the 83rd Annual Meeting of the Transportation Research Board, Washington, D.C., January 2004.
- European Commission and Directorate-General Transport and Energy. "Older Drivers." www.erso.eu/knowledge/Fixed/06_drivers/20_old/olderdrivers.pdf. Accessed January 2007.
- Fisk, C. S. "Traffic Performance Analysis at Roundabouts," *Transportation Research B*, Vol. 25B, Bi. 2/3, 1991, pp. 89–102.
- Flannery, A. "Geometric Design and Safety Aspects of Roundabouts." *Transportation Research Record: Journal of the Transportation Research Board*, No. 1751, Washington, D.C.: TRB, National Research Council, 2001, pp 76–81.
- Flannery, A. and T. K. Datta. "Modern Roundabouts and Traffic Crash Experience in the United States." In *Transportation Research Record 1553*. Washington, D.C.: TRB, National Research Council, 1996.
- Flannery, A. and T. K. Datta. "Operational Performance Measures of American Roundabouts." Presented at the 76th Annual Meeting of the Transportation Research Board, Washington, D.C., January 1997.
- Flannery A., L. Elefteriadou, P. Koza, and J. McFadden. "Safety, Delay and Capacity of Single-Lane Roundabouts in the United States." In *Transportation Research Record 1646*. Washington, D.C.: TRB, National Research Council, 1998, pp. 63–70.
- Fortuijn, L. G. H. and V. F. Harte. "Meerstrooksrotondes: verkenning can nieuwe vormen" ("Turbo-roundabouts: A well-tried concept in a new guise"). *Verkeerskundige werkdagen 1997*, CROW, Ede., Netherlands, 1997.
- Gambard, J. M. "Safety and Design of Unsignalized Intersections in France," *Intersections without Traffic Signals I*, Springer-Verlag, W. Brilon, ed., 1991, pp. 48–61.
- Garber, N. and R. Srinivasan. "Characteristics of accidents involving elderly drivers at intersections." *Transportation Research Record No. 1325*. Washington, D.C.: TRB, National Research Council, 1991, pp. 8–16.
- Geruschat, D. R. and S. E. Hassan. Yielding Behavior of Drivers to Sighted and Blind Pedestrians at Roundabouts. *Journal of Visual Impairment and Blindness*, 99, 2004, pp. 286–302.
- Guichet, B. "Roundabouts in France: Development, Safety, Design, and Capacity." In *Proceedings of the Third International Symposium on Intersections without Traffic Signals*, M. Kyte, ed., Moscow, Idaho: University of Idaho, 1997.
- Guth, D., D. Ashmead, R. Long, R. Wall, and P. Ponchillia. "Blind and Sighted Pedestrians' Judgments of Gaps in Traffic at Roundabouts." *Human Factors*, 47, 2005, pp. 314–331.

- Hagring, O. "Derivation of Capacity Equation for Roundabout Entry with Mixed Circulating and Exiting Flows." *Transportation Research Record No. 1776*. Washington, D.C.: Transportation Research Board of the National Academies, 2001, pp 91–99.
- Hagring, O. "Effects of OD Flows on Roundabout Entry Capacity." *Transportation Research Circular E-C018: Fourth International Symposium on Highway Capacity*. Washington, D.C.: TRB, National Research Council, 2000, pp. 434–445.
- Hagring, O. "The Use of the Cowan M3 Distribution for Modeling Roundabout Flow." *Traffic Engineering & Control*, May 1996, pp. 328–332.
- Hagring, O., N. Roupail, and H. Sorensen. "Comparison of Capacity Models for Two-Lane Roundabouts." *Transportation Research Record: Journal of the Transportation Research Board, No. 1852*. Washington, D.C.: Transportation Research Board of the National Academies, 2003, pp. 114–123.
- Hakkert, A., S. D. Mahalel, and S. A. Asante. "A Comparative Study of Roundabout Capacity Procedures." *Intersections without Traffic Signals I*, Springer-Verlag, W. Brilon, ed., 1991, pp. 93–106.
- Hallworth, M. S. "Signalling Roundabouts." In *Traffic Engineering & Control*, Vol. 33, No. 6, June 1992.
- Harders, J. *Grenz- und Folgezeitlücken als Grundlage für die Berechnung der Leistungsfähigkeit von Landstrassen* (Critical gaps and follow-up times for capacity calculations at rural roads). Schriftenreihe Strassenbau und Strassenverkehrstechnik, Vol. 216, 1976.
- Harkey, D. and D. Carter. "Observational Analysis of Pedestrian, Bicyclist, and Motorist Behaviors at Roundabouts in the United States." *Transportation Research Record: Journal of the Transportation Research Board, No. 1982*. Washington, D.C.: Transportation Research Board of the National Academies, 2006, pp. 155–165.
- Harper, N. J. and R. C. M. Dunn. "Accident Prediction at Urban Roundabouts in New Zealand: Some Initial Results." 26th Australasian Transport Research Forum, Wellington New Zealand, October 1–3, 2003.
- Harper, N. J. and R. C. M. Dunn. "Accident Prediction Models at Roundabouts." Presented at the 2005 ITE Annual Meeting in Melbourne, Australia, 2005. http://www.ite.org/meetcon/2005AM/Harper_Wed.pdf. Accessed 2007.
- Heidemann, D. "Queue lengths and waiting-time distributions at priority intersections." In *Transportation Research B*, Vol 25B, (4), 1991, pp. 163–174.
- Hermes, B. F. "Some Visual Aspects of Pedestrian Crosswalks." In *Proceedings, 22nd California Street and Highway Conference*, Institute of Transportation and Traffic Engineering, University of California, Los Angeles, January 1970.
- Hoglund, P. G. "Case Study: Performance Effects of Changing a Traffic Signal Intersection to Roundabout." *Intersections without Traffic Signals I*, Springer-Verlag, W. Brilon, ed., 1991, pp. 141–158.

- Horman, C. B. "Design and Analysis of Roundabouts." *Proceedings 7th ARRB Conference*, Vol. 7, Part 4, 1974, pp. 58–82.
- Hughes, B. P. "So You Think You Understand Gap Acceptance!" *Australian Road Research Board*, 19(3), 1989, pp. 195–204.
- Hughes, R., B. Schroeder, and T. Fischer. "3D Visualization and Micro-Simulation Applied to the Identification and Evaluation of Geometric and Operational 'Solutions' for Improving Visually Impaired Pedestrian Access to Roundabouts and Channelized Turn Lanes." Presented at the Transportation Research Board National Roundabout Conference, Vail, CO, May 2005.
- Inman, V., B. Katz, and F. Hanscom. "Navigation Signing for Roundabouts." *Transportation Research Record: Journal of the Transportation Research Board*, No. 1973, Washington, D.C.: Transportation Research Board of the National Academies, 2006, pp. 18–26.
- Insurance Institute of Highway Safety. *Status Report*, Vol. 36, Number 7. Arlington, Virginia: Insurance Institute of Highway Safety, 2001.
- Isebrands, H. and S. Hallmark. "Assessing the Air Quality Benefits of Roundabouts." 2006 Air and Waste Management Association Annual Meeting, New Orleans, Louisiana, June 2006.
- ITE Technical Council committee 5B-17. "Use of Roundabouts." *ITE Journal*, Feb. 1992, pp. 42–45.
- Jessen, G. D. Ein Richtlinienvorschlag für die Behandlung der Leistungsfähigkeit von Knotenpunkten ohne Signalregelung (A guideline suggested for capacity calculations for unsignalized intersections). *Strassenverkehrstechnik*, Nr. 7/8, 1968.
- Johnson, W. and A. Flannery. "Estimating Speeds at High Speed Rural Roundabouts." *Compendium of Papers*, 3rd International Symposium on Highway Geometric Design. Washington, D.C.: Transportation Research Board of the National Academies, 2005.
- Jones, S. E. "Signalling Roundabouts 2. Controlling the Revolution." *Traffic Engineering & Control*, Vol. 33, No. 11, November 1992, pp. 606–613.
- Kennedy, J., J. Peirce, and I. Summersgill. "International Comparison of Roundabout Design Guidelines." *Compendium of Papers*, 3rd International Symposium on Highway Geometric Design. Washington, D.C.: Transportation Research Board of the National Academies, 2005.
- Kimber, R. M. "The Design of Unsignalized Intersections in the UK." *Intersections without Traffic Signals I*, Springer-Verlag, W. Brilon, ed., 1991, pp. 20–34.
- Kimber, R. M. "Gap-Acceptance and Empiricism in Capacity Prediction," *Transportation Science*, Vol. 23, No. 2, 1989.
- Krogscheepers, J. and C. Roebuck. "Unbalanced Traffic Volumes at Roundabouts." *Transportation Research Circular E-C018: Fourth International Symposium on Highway Capacity*. Washington, D.C.: TRB, National Research Council, 2000, pp. 446–458.

- Lalani, N. "The Impact on Accidents of the Introduction of Mini, Small and Large Roundabouts at Major/Minor Priority Junctions." *Traffic Engineering & Control*, December 1975.
- Lamm, R. and E. M. Choueiri. "Recommendations for Evaluating Horizontal Design Consistency Based on Investigations in the State of New York." In *Transportation Research Record 1122*. Washington, D.C.: TRB, National Research Council, 1987.
- Layfield, R. E. and G. Maycock. "Pedal-Cyclists at Roundabouts." *Traffic Engineering & Control*, June 1986, pp. 343–349.
- List, G., S. Leong, Y., Embong, N. Azizan, and J. Conley. "Case Study Investigation of Traffic Circle Capacity," *Transportation Research Record 1457*, Washington, D.C.: TRB, National Research Council, 1994, pp. 118–126.
- Little, J. D. C. "A Proof of the Queueing Formula $L = W \cdot \lambda$." *Operations Research* 9, 1961, S. 383–387.
- Lutkevich, P. and P. Hasson. "An Examination and Recommendation for Current Practices in Roundabout Lighting." *National Roundabout Conference: 2005 Proceedings*, Washington, D.C.: Transportation Research Board of the National Academies, May 2005.
- McCulloch, H. "The Roundabout Design Process—Simplified." Transportation Research Board National Roundabout Conference, Kansas City, Missouri, 2008. <http://teachamerica.com/RAB08/RAB08S3BMcCulloch/index.htm>.
- McDonald, M. and D. J. Armitage. "The capacity of roundabouts." *Traffic Engineering & Control*, Vol. 19, October 1978, pp. 447–450.
- Mereszczak, Y., M. Dixon, M. Kyte, L. Rodegerdts, and M. Blogg. "Including Exiting Vehicles in Capacity Estimation at Single-Lane U.S. Roundabouts." *Transportation Research Record: Journal of the Transportation Research Board*, No. 1988, Washington, D.C.: Transportation Research Board of the National Academies, 2006, pp. 23–30.
- Myers, E. J. "Modern Roundabouts for Maryland." *ITE Journal*, Oct. 1994, pp. 18–22.
- Niederhauser, M. E., B. A. Collins, and E. J. Myers. "The Use of Roundabouts: Comparison with Alternate Design Solution." *Compendium of Technical Papers*, 67th Annual Meeting, Institute of Transportation Engineers, August 1997.
- North Carolina State University. Report from NCHRP Project 3-78/3-78A: Crossing Solutions at Roundabouts and Channelized Turn Lanes for Pedestrians with Vision Disabilities. Washington, D.C.: Transportation Research Board of the National Academies. Forthcoming.
- Noyce, D. A. and K. C. Kacir. "Drivers' Understanding of Protected-Permitted Left-Turn Signal Displays." *Transportation Research Record: Journal of the Transportation Research Board*, No. 1754, Washington, D.C.: Transportation Research Board of the National Academies, 2001, pp. 1–10.

- Oh, H. and V. Sisiopiku. "Probalistic Models for Pedestrian Capacity and Delay at Roundabouts." *Transportation Research Circular E-C018: Fourth International Symposium on Highway Capacity*. Washington, D.C.: TRB, National Research Council, 2000, pp. 459–470.
- Orchard Hiltz & McCliment, Inc., and Hampton Engineering Associates, Inc. "Staging Construction." Construction plans for Baldwin/Indianwood/Coats Road Roundabout, Oakland County, Michigan, 2003.
- Ourston, L. "Wide Nodes and Narrow Roads." Presented at the 72nd Annual Meeting of the Transportation Research Board, Washington, D.C., 1993.
- Ourston, L. "British Interchanges, Intersections, and Traffic Control Devices." *Westernite*, Vol. XXXV, No. 5, September–October 1992.
- Ourston, L. and J. G. Bared. "Roundabouts: A Direct Way to Safer Highways." *Public Roads*, Autumn 1995, pp. 41–49.
- Ourston, L. and G. A. Hall. "Modern Roundabout Interchanges Come to America." *1996 ITE Compendium of Technical Papers*.
- Oxley, J., B. Corben, and B. Fildes. "Older Driver Highway Design: The Development of a Handbook and Training Workshop to Design Safe Road Environments for Older Drivers." Traffic Safety on Three Continents Conference, Moscow, Russia, 2001.
- Paramics, Ltd. "Comparison of Arcady and Paramics for Roundabout Flows." Version 0.3. August 23, 1996.
- Pearce, C. E. M. "A Probabilistic Model for the Behavior of Traffic at Roundabouts." *Transportation Research B*, Vol. 21B, No. 3, 1987, pp. 207–216.
- Persaud, B., R. Retting, P. Garder, and D. Lord. "Safety Effects of Roundabout Conversions in the United States: Empirical Bayes Observational Before-After Study." *Transportation Research Record: Journal of the Transportation Research Board*, No. 1751, Washington, D.C.: Transportation Research Board of the National Academies, 2001, pp. 1–8.
- Pratelli, A. "Design of Modern Roundabouts in Urban Traffic Systems." 12th International Conference on Urban Transport and the Environment. Wessex Institute of Technology, Prague, Czech Republic, July 2006.
- Pratelli, A. "Rotatorie Di Nuova Generazione." Pisa, Italy: Universita di Pisa, February 2004.
- Preusser, D., A. Williams, S. Ferguson, R. Ulmer, and H. Weinstein. "Fatal Crash Risk for Older Drivers at Intersections." *Accident Analysis and Prevention*, 30 (2), 1998, pp 151–159.
- Queensland Department of Main Roads (QDMR). "Relationships between Roundabout Geometry and Accident Rates." Queensland, Australia: Infrastructure Design of the Technology Division of QDMR, April 1998.
- Rahman, M. A. "Design Criteria for Roundabouts." *1995 ITE Compendium of Technical Papers*.

- Redington, T. "The Modern Roundabout Arrives in Vermont." *AASJTP Quarterly Magazine*, Vol. 75, No. 1, 1995, pp. 11–12.
- Retting, R., S. Kyrvchenko, and A. McCartt. "Long-Term Trends in Public Opinion Following Construction of Roundabouts." Presented at the 86th Annual Meeting of the Transportation Research Board, Washington, D.C., 2007.
- Retting, R., G. Luttrell, and E. Russell. "Public Opinion and Traffic Flow Impacts of Newly Installed Modern Roundabouts in the United States." Arlington, VA: Insurance Institute of Highway Safety, August 2001.
- Rouphail, N., R. Hughes, and K. Chae. "Exploratory Simulation of Pedestrian Crossings at Roundabouts." *ASCE Journal of Transportation Engineering*, Vol. 131, 2005, p. 211.
- Schoon, C. C. and J. van Minnen. "The Safety of Roundabouts in the Netherlands." *Traffic Engineering & Control*, Vol. 35, No. 3, 1994, pp. 142–148.
- Schoon, C. C. and J. van Minnen. "Accidents on Roundabouts: II. Second Study into the Road Hazard Presented by Roundabouts, Particularly with Regard to Cyclists and Moped Riders." R-93-16. The Netherlands: SWOV Institute for Road Safety Research, 1993.
- Schroeder, B. "Microsimulation of Pedestrian-Vehicle Interaction: Evaluating Pedestrian Crossing Treatments for NCHRP 3-78 in VISSIM." Presented at the NCITE Mid-year Meeting, June 2006.
- Schroeder, B., N. Rouphail, and R. Wall. "Exploratory Analysis of Crossing Difficulties for Blind and Sighted Pedestrians at Channelized Turn Lanes." Presented at the 86th Annual Meeting of the Transportation Research Board, Washington, D.C., January 2007.
- Scialfa, C. T., L. T. Guzy, H. W. Leibowitz, P. M. Garvey, and R. A. Tyrrell. "Age Differences in Estimating Vehicle Velocity." *Psychology and Aging*, Vol. 6, No. 1, 1991, pp. 60–66.
- Seim, K. "Use, Design and Safety of Small Roundabouts in Norway." In *Intersections without Traffic Signals II*, Springer-Verlag, W. Brilon, ed., 1991, pp. 270–281.
- Service d'Études Techniques des Routes et Autoroutes (Sétra). *Carrefours Giratoires: Evolution des Caractéristiques Géométriques*, Ministère de l'Équipement, du Logement, de l'Aménagement du Territoire et des Transports, Documentation Technique 44, Sétra, August 1997, and 60, Sétra, May 1988.
- Sétra/CETE de l'Ouest. "Safety Concerns on Roundabouts," 1998.
- Simon, M. J. "Roundabouts in Switzerland." *Intersections without Traffic Signals II*, Springer-Verlag, W. Brilon, ed., 1991, pp. 41–52.
- Smith, M. J. "Improved Signing for Traffic Circles." New Jersey Department of Transportation, FHWA/NJ-91-003 91-003-7350, 1990.
- Smith, S. A. and R. L. Knoblauch. "Guidelines for the Installation of Crosswalk Markings." In *Transportation Research Record 1141*. Washington, D.C.: TRB, National Research Council, 1987.

- Spacek, P. "Basis of the Swiss Design Standard for Roundabouts." *Transportation Research Record: Journal of the Transportation Research Board*, No. 1881, Washington, D.C.: Transportation Research Board of the National Academies, 2004, pp. 27–35.
- Staplin, L. "Simulator and Field Measures of Driver Age Differences in Left-Turn Gap Judgments." *Transportation Research Record 1485*. Washington, D.C.: TRB, National Research Council, 1995, pp. 49–55.
- State of California Department of Transportation. "Revised Design Bulletin 80: Roundabouts." DIB 80-01. Sacramento, CA. October 3, 2003.
- Stutts, J. "Improving the Safety of Older Road Users." *NCHRP Synthesis 378: State Highway Cost Allocation Studies*. Washington, D.C.: Transportation Research Board of the National Academies, 2005.
- Stuwe, B. "Capacity and Safety of Roundabouts—German Results." *Intersections without Traffic Signals II*, Springer-Verlag, W. Brilon, ed., 1991, pp. 1–12.
- Tan, Jian-an. "A Microscopic Simulation Model of Roundabout Entry Operations." *Intersections without Traffic Signals I*, Springer-Verlag, W. Brilon, ed., 1991, pp. 159–176.
- Tanyel, S., T. Baran, and M. Özuysal. "Determining the Capacity of Single-Lane Roundabouts in Izmir, Turkey." *ASCE Journal of Transportation Engineering*, Vol. 131, 2005, p. 953.
- Taylor, M. C. "UK Techniques for the Prediction of Capacities, Queues, and Delays at Intersections without Traffic Signals." *Intersections without Traffic Signals I*, Springer-Verlag, W. Brilon, ed., 1991, pp. 274–288.
- Technical Research Centre of Finland (VTT). "Traffic Effects of a Roundabout." *Nordic Road & Transport Research*, No. 1, 1993, pp. 9–11.
- Todd, K. "A History of Roundabouts in Britain." *Transportation Quarterly*, Vol. 45, No. 1, January 1991.
- Tracz, M. "Country Report—Poland: Roundabouts Use in Poland and Developments in Their Design." *Compendium of Papers*, 3rd International Symposium on Highway Geometric Design. Washington, D.C.: Transportation Research Board of the National Academies, 2005.
- Transfund. "Ins and Outs of Roundabouts: Safety Auditor's Perspective." Wellington, NZ: Transfund New Zealand, 2000.
- Troutbeck, R. J. "Capacity and Design of Traffic Circles in Australia." *Transportation Research Record 1398*. Washington, D.C.: TRB, National Research Council, 1993, pp. 68–74.
- Troutbeck, R. J. "Effect of Heavy Vehicles at Australian Traffic Circles and Unsignalized Intersections." *Transportation Research Record 1398*. Washington, D.C.: TRB, National Research Council, 1993, pp. 54–60.
- Troutbeck, R. J. "Changes to Analysis and Design of Roundabouts Initiated in the Austroads Guide." *Proceedings 16th ARRB Conference*, Vol. 16, Part 5, 1992.

- Troutbeck, R. J. "Current and Future Australian Practices for the Design of Unsignalized Intersections." *Intersections without Traffic Signals I*, Springer-Verlag, W. Brilon, ed., 1991, pp. 1–19.
- Troutbeck, R. J. "Recent Australian Unsignalized Intersection Research and Practices." *Intersections without Traffic Signals II*, Springer-Verlag, W. Brilon, ed., 1991, pp. 238–257.
- Troutbeck, R. J. "Traffic Interactions at Roundabouts." *Proceedings 15th ARRB Conference*, Vol. 15, Part 5, 1990.
- Troutbeck, R. J. "Does Gap Acceptance Theory Adequately Predict the Capacity of a Roundabout." *Proceedings 12th ARRB Conference*, Vol. 12, Part 4, 1985, pp. 62–75.
- Troutbeck, R. J. "Capacity and Delays at Roundabouts: A Literature Review." *Australian Road Research Board*, 14(4), 1984, pp. 205–216.
- Tudge, R. T. "Accidents at Roundabouts in New South Wales." *Proceedings 15th ARRB Conference*, Vol. 15, Part 5, 1990.
- Turner, S., G. Wood, and A. Roozenburg. "Accident Prediction Models for Roundabouts." 22nd Australian Road Research Board Conference, Melbourne, Australia, 2006.
- Turner, S., G. Wood, and A. Roozenburg. "Rural Intersection Accident Prediction Models." 22nd Australian Road Research Board Conference, Melbourne, Australia, 2006.
- University of Nevada–Reno, California State University–Chico, and Kittelson & Associates, Inc. Caltrans Research Project (#65A0229), Development of Roundabout Geometric Design Recommendations. Caltrans. Ongoing.
- van Minnen, J. "Roundabouts." Institute for Road Safety Research SWOV, Netherlands (1986)
- van Minnen, J. "Safety of Bicyclists on Roundabouts Deserves Special Attention," SWOV Institute of Road Safety Research in the Netherlands, *Research Activities* 5, March 1996.
- Virginia Department of Transportation. Roundabouts in Virginia. <http://www.virginiadot.org/info/faq-roundabouts.asp>. Accessed March 2009.
- Vogt, A. "Crash Models for Rural Intersections: 4-Lane by 2-Lane Stop-Controlled and 2-Lane by 2-Lane Signalized." Washington, D.C.: FHWA, 1999.
- Wadhwa, L. "Roundabouts and Pedestrians with Visual Disabilities: How Can We Make Them Safer?" Presented at the 82nd Annual Meeting of the Transportation Research Board, Washington, D.C., 2003.
- Wallwork, M. J. "Roundabouts." Genesis Group, Inc.
- Wan, B. and N. Roupail. "Using Arena for Simulation of Pedestrian Crossing in Roundabout Areas." *Transportation Research Record No. 1878*. 2004, pp. 58–65.
- Washington State Department of Transportation. Work Zone Traffic Control Plans. <http://www.wsdot.wa.gov/Design/Standards/PlanSheet/WZ-1.htm>. Accessed August 2009.

- Whipple, M. "Curb Ramp Design by Elements and Planter Strip Curb Ramp." *Proceedings of the Wayfinding at Intersections Workshop*. Washington, D.C.: Institute of Transportation Engineers/U.S. Access Board, 2004.
- Williams, J. C., S. A. Ardekani, and S. A. Asante. "Motorist Understanding of Left-Turn Signal Indications and Auxiliary Signs." *Transportation Research Record 1376*. Washington, D.C.: TRB, National Research Council, 1992, pp. 57–63.
- Wong, S. C. "On the Reserve Capacities of Priority Junctions and Roundabouts." *Transportation Research*, Vol. 30, No. 6, 1996, pp. 441–453.
- Worthington, J. C. "Roundabout Design: A Comparison of Practice in the UK and France." Proceedings of Seminar H Held at the PTRC Transport, Highways and Planning Summer Annual Meeting, University of Manchester Institute of Science And Technology, England (from September 14–18, 1992) pp. 269–279.
- Wu, N. "An Approximation for the Distribution of Queue Lengths at Unsignalized Intersections." In *Proceedings of the Second International Symposium on Highway Capacity*. R. Akçelik, ed., Sydney, Australia: Australian Road Research Board, 1994.

LEGISLATION

- State of Montana Legislature. Encourage Construction of Roundabouts. Bill Number HJ 0012. 2005 Session. <http://data.opi.state.mt.us/bills/2005/BillPDF/HJ0012.pdf>. Accessed May 2007.
- State of Oregon. Oregon Revised Statute 811.400. <http://www.leg.state.or.us/ors/811.html>. Accessed March 2009.
- State of Vermont Legislature. Legislative Support for Roundabouts. Specific House or Senate Bills. Bill Number H.764, Section 37. 2001-2002 Session. <http://www.leg.state.vt.us/docs/2002/bills/passed/H-764.HTM>. Accessed May 2007.
- State of Virginia Legislature. Encouraging the Department of Transportation to Construct More Roundabouts Instead of Signalized Intersections. Bills and Resolutions. Bill HJ 594ER. 2003. <http://leg1.state.va.us/cgi-bin/legp504.exe?031+ful+HJ594ER>. Accessed May 2007.

DRIVER MANUALS AND USER EDUCATION

- Alaska Department of Administration Division of Motor Vehicles. Alaska Drivers Manual. <http://www.state.ak.us/dmv/dlmanual/dlman.pdf>. Accessed October 2008.

- City of Bend, Oregon. Roundabouts: Another Safe Intersection. <http://www.ci.bend.or.us/roundabouts/index.html>. Accessed October 2008.
- State of Arizona. *Arizona Driver License Manual and Customer Service Guide*. Arizona Department of Transportation: Motor Vehicle Division, 2007, p. 27.
- State of California. *California Driver Handbook 2007*. California Department of Motor Vehicles, 2007, p. 17.
- State of Florida. *Florida Driver's Handbook*, Chapter 3. Florida Department of Highway Safety and Motor Vehicles, 2003.
- Kansas Department of Revenue. *Kansas Driving Handbook*. Kansas Driver's License Examining Bureau. May 2003. p. 50. <http://www.ksrevenue.org/dmvdhandbook.htm>. Accessed October 2008.
- Lowest Price Traffic School. Florida Drivers Handbook. <http://www.lowestprice-trafficsschool.com/handbooks/driver/en/3/5>. Accessed October 2008.
- State of Maryland. *Maryland Driver's Handbook*. Maryland Motor Vehicle Administration, 2004, pp. 33–35.
- State of Michigan. *What Every Driver Must Know*. 2006, p. 83.
- State of Minnesota. *Minnesota Driver's Manual*. Minnesota Department of Public Safety: Driver and Vehicle Services, 2007, p. 25.
- State of Missouri. *Driver Guide*. Missouri Department of Revenue, September 2006, pp. 38, 43, 45, 49.
- State of Nevada. *Driver's Handbook*. Nevada Department of Motor Vehicles, 2006, p. 34.
- State of New York. *Driver's Manual and Study Guide*, Chapter 8. New York State Department of Motor Vehicles, 2006.
- Oregon Department of Motor Vehicles. *Oregon Driver Manual 2005–2007*. Oregon Driver and Motor Vehicle Services, 2006, pp. 17, 38, 50.
- State of Pennsylvania. *Pennsylvania Driver's Manual*. Pennsylvania Department of Transportation: Driver and Vehicle Services, 2006, p. 41.
- State of Vermont. *Vermont Driver's Manual*. Vermont Department of Motor Vehicles, 2006, p. 37.
- Virginia Department of Motor Vehicles. Virginia Driving Manual. <http://www.dmv.state.va.us/exec/link.asp?824>. Accessed October 2008.
- Virginia Department of Transportation. Roundabouts in Virginia. <http://www.virginiadot.org/info/faq-roundabouts.asp>. Accessed October 2008.
- State of Washington. *Washington Driver Guide*. Washington Department of Licensing, 2006, pp. 33, 40.
- State of Wisconsin. *Motorists' Handbook*. Wisconsin Department of Transportation, 2005, p. 20.

**APPENDIX A
EXAMPLE PAVEMENT MARKING DESIGNS
FOR ROUNDABOUTS**

CONTENTS

A.1 EXAMPLE PAVEMENT MARKINGS A-3

LIST OF EXHIBITS

Exhibit A-1 Example Markings for a Single-Lane Roundabout A-3

Exhibit A-2 Example Markings for a Single-Lane Roundabout
with a Dedicated Right-Turn Lane A-4

Exhibit A-3 Example Markings for a Double-Lane Roundabout
with Single-Lane and Double-Lane Approaches and
with Extended Splitter Islands A-5

Exhibit A-4 Example Markings for a Double-Lane Roundabout
with Single- and Double-Lane Approaches and
with Central Island Extended by Pavement Markings A-6

Exhibit A-5 Example Markings for a Double-Lane Roundabout
with Single- and Double-Lane Approaches and
with Central Island Extended by Truck Apron A-6

Exhibit A-6 Example Markings for a Double-Lane Roundabout
with Single-Lane Exits A-7

Exhibit A-7 Example Markings for a Double-Lane Roundabout
with Double-Lane Exits (typical double-lane roundabout) A-8

Exhibit A-8 Example Markings for a Double-Lane Roundabout
with Double Left-Turn Lane A-9

Exhibit A-9 Example Markings for a Double-Lane Roundabout
with Double Right-Turn Lane A-10

Exhibit A-10 Example Markings for a Double-Lane Roundabout
with Consecutive Double Left Turns A-11

Exhibit A-11 Example Markings for a Three-Lane Roundabout
with Two- and Three-Lane Approaches A-12

Exhibit A-12 Example Markings for a Three-Lane Roundabout
with Three-Lane Approaches A-13

Exhibit A-13 Example Markings for a Three-Lane Roundabout
with Two-Lane Exits and Double Left Turns
on All Approaches A-14

Exhibit A-14 Example Markings for Two Linked Roundabouts A-15

Exhibit A-15 Example Markings for a Diamond Interchange
with Two Circular-Shaped Roundabout
Ramp Terminals A-16

Exhibit A-16 Example Markings for a Diamond Interchange
with Two Raindrop-Shaped Roundabout
Ramp Terminals A-17

A.1 EXAMPLE PAVEMENT MARKINGS

Exhibits A-1 through A-16 illustrate examples of markings for roundabouts with various geometric design and lane-use configurations from the 2009 *Manual on Uniform Traffic Control Devices* (see Chapter 7 for reference). This series of exhibits is not an exhaustive set of examples of every possible roundabout configuration. However, the examples show many complex lane-use arrangements and do a good job of illustrating the general principles for marking roundabouts as described in Chapter 7. Most importantly, the examples illustrate how drivers can choose the appropriate lane when entering a roundabout and not need to change lanes within the circulatory roadway before exiting in their desired direction.

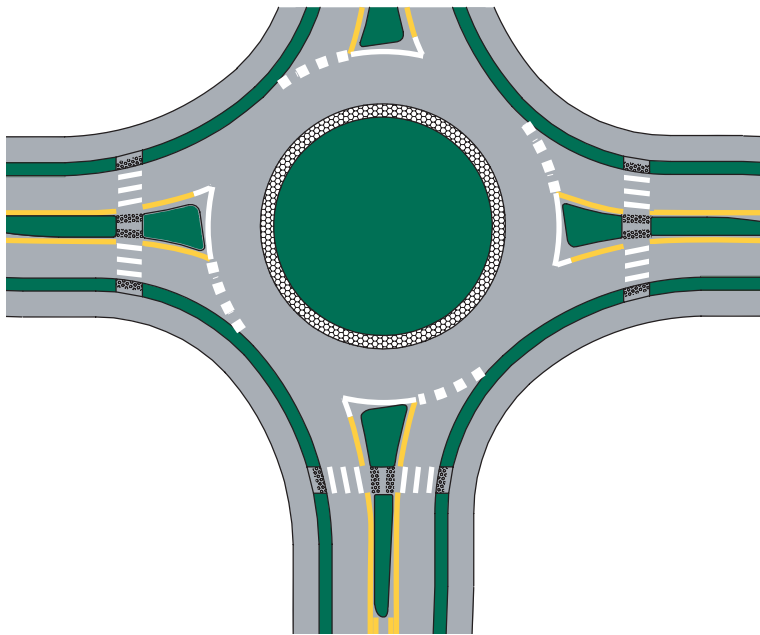
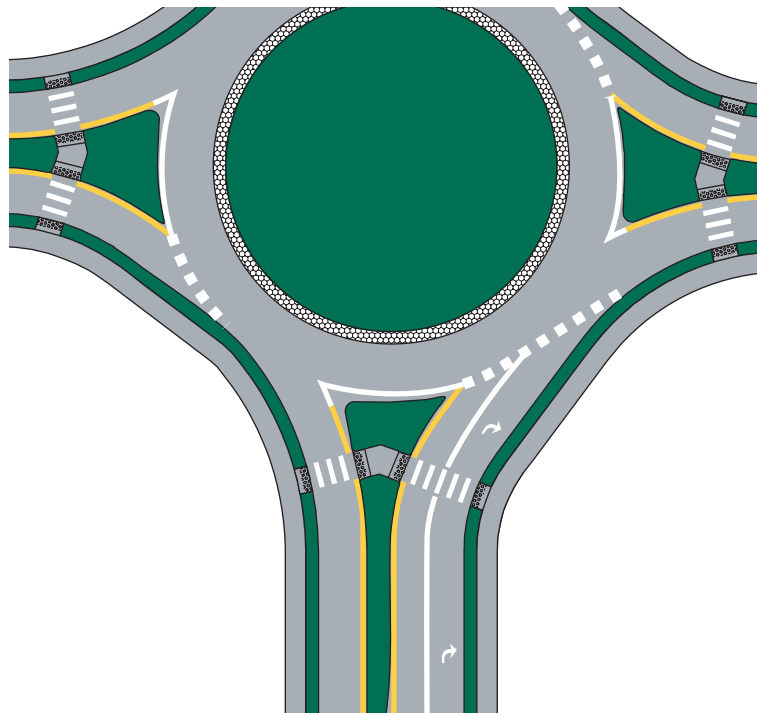

Exhibit A-1
Example Markings for a
Single-Lane Roundabout

Roundabouts: An Informational Guide

Exhibit A-2
Example Markings for a
Single-Lane Roundabout with
a Dedicated Right-Turn Lane



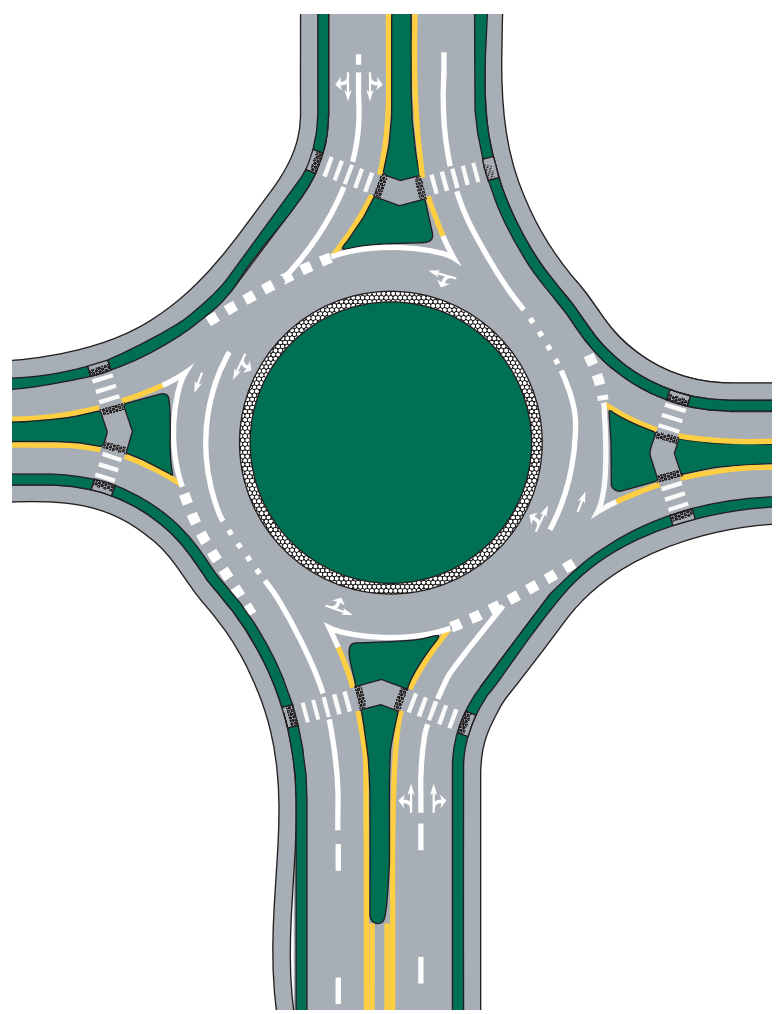

Exhibit A-3
Example Markings for a
Double-Lane Roundabout
with Single-Lane and Double-
Lane Approaches and with
Extended Splitter Islands

Roundabouts: An Informational Guide

Exhibit A-4
Example Markings for a
Double-Lane Roundabout
with Single- and Double-Lane
Approaches and with
Central Island Extended by
Pavement Markings

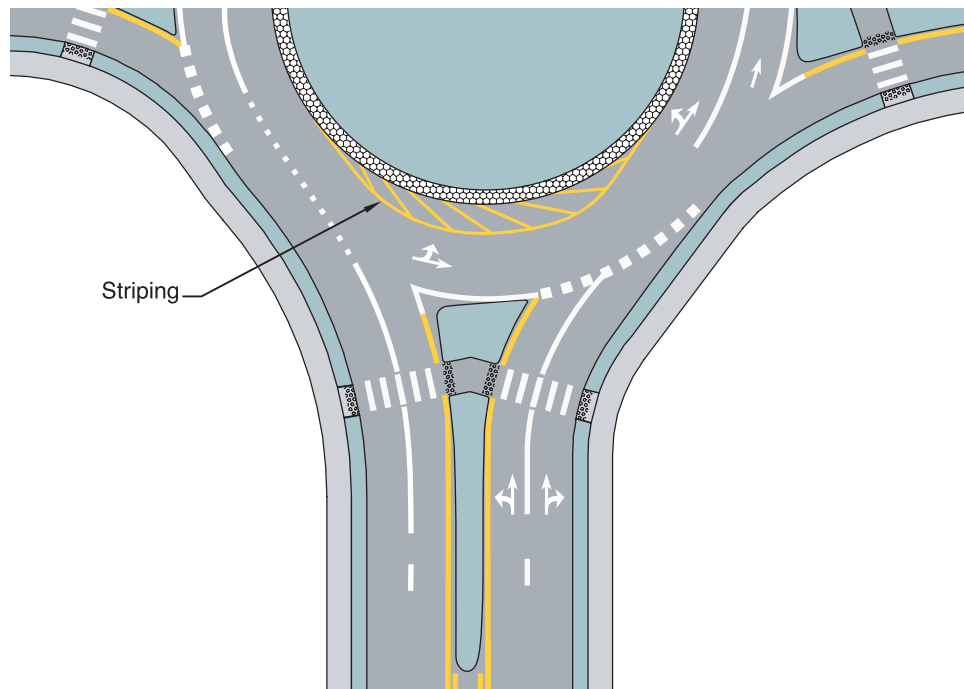
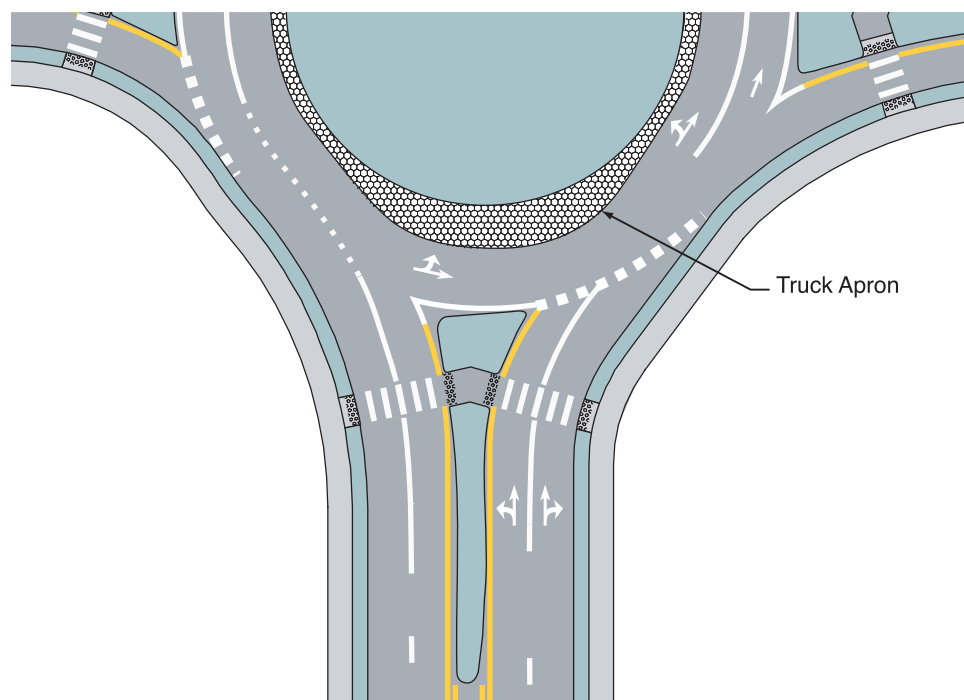

Exhibit A-5
Example Markings for a
Double-Lane Roundabout
with Single- and Double-Lane
Approaches and with
Central Island Extended by
Truck Apron



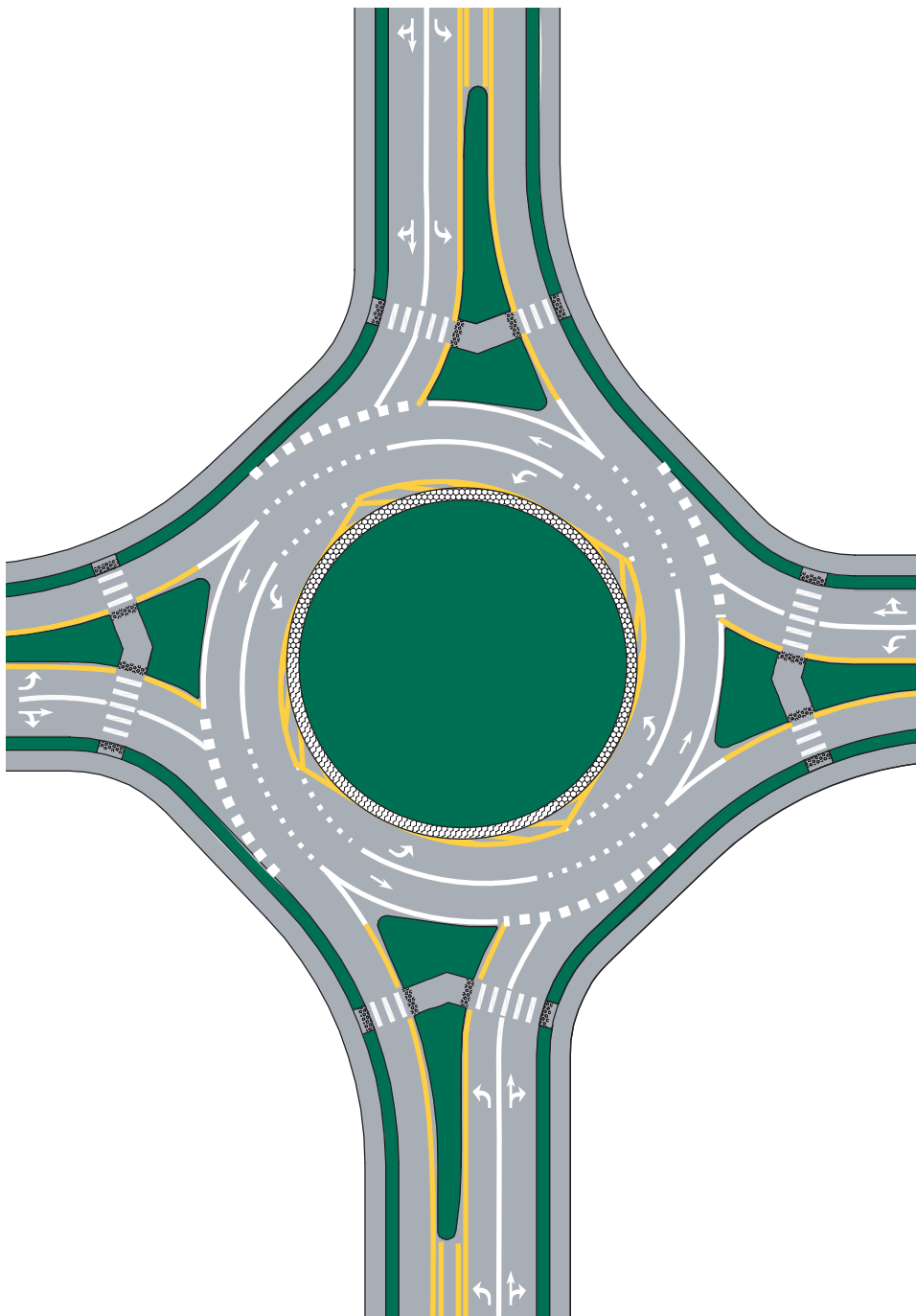
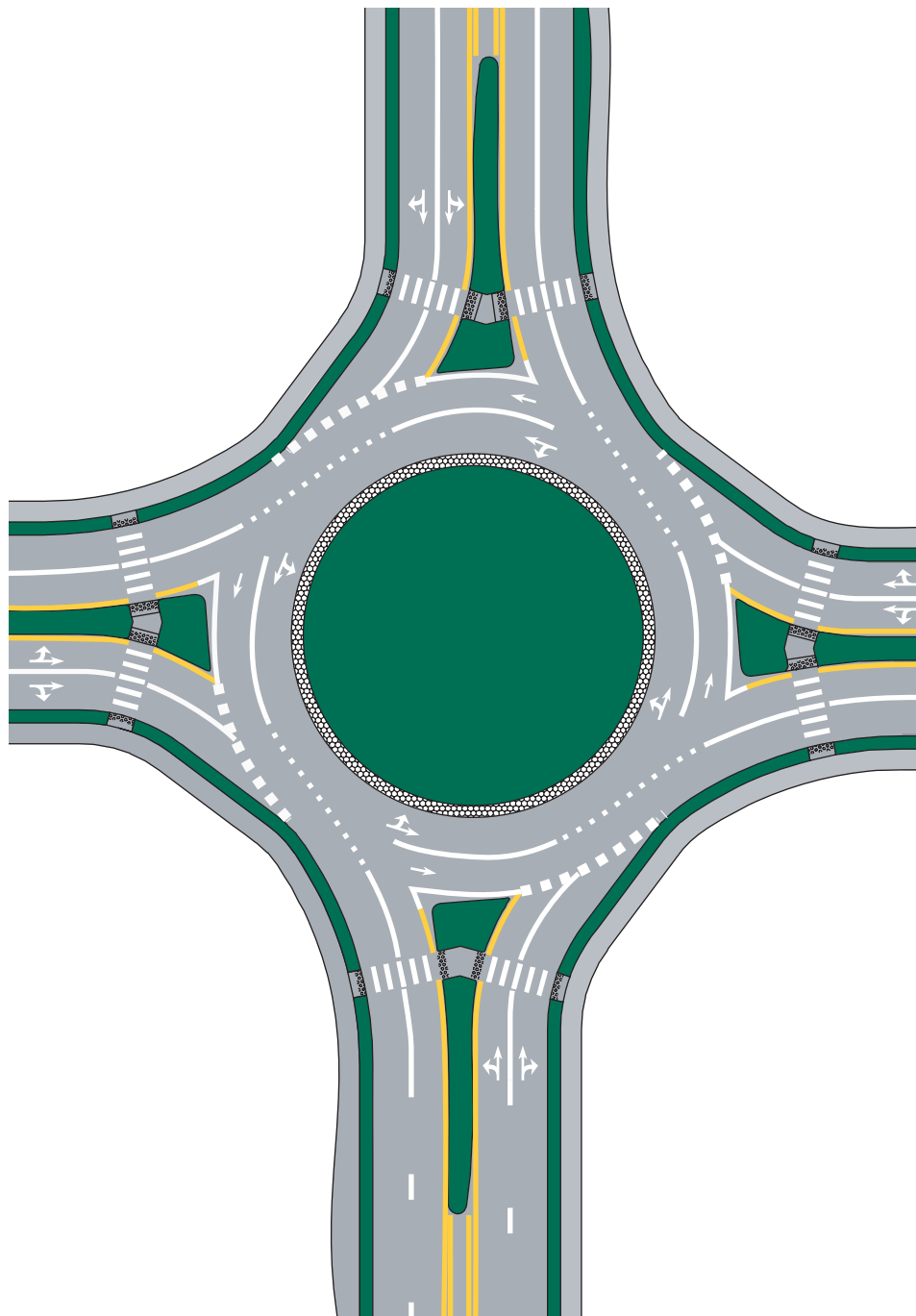

Exhibit A-6
Example Markings for a
Double-Lane Roundabout
with Single-Lane Exits

Roundabouts: An Informational Guide

Exhibit A-7
Example Markings for a
Double-Lane Roundabout
with Double-Lane Exits
(typical double-lane
roundabout)



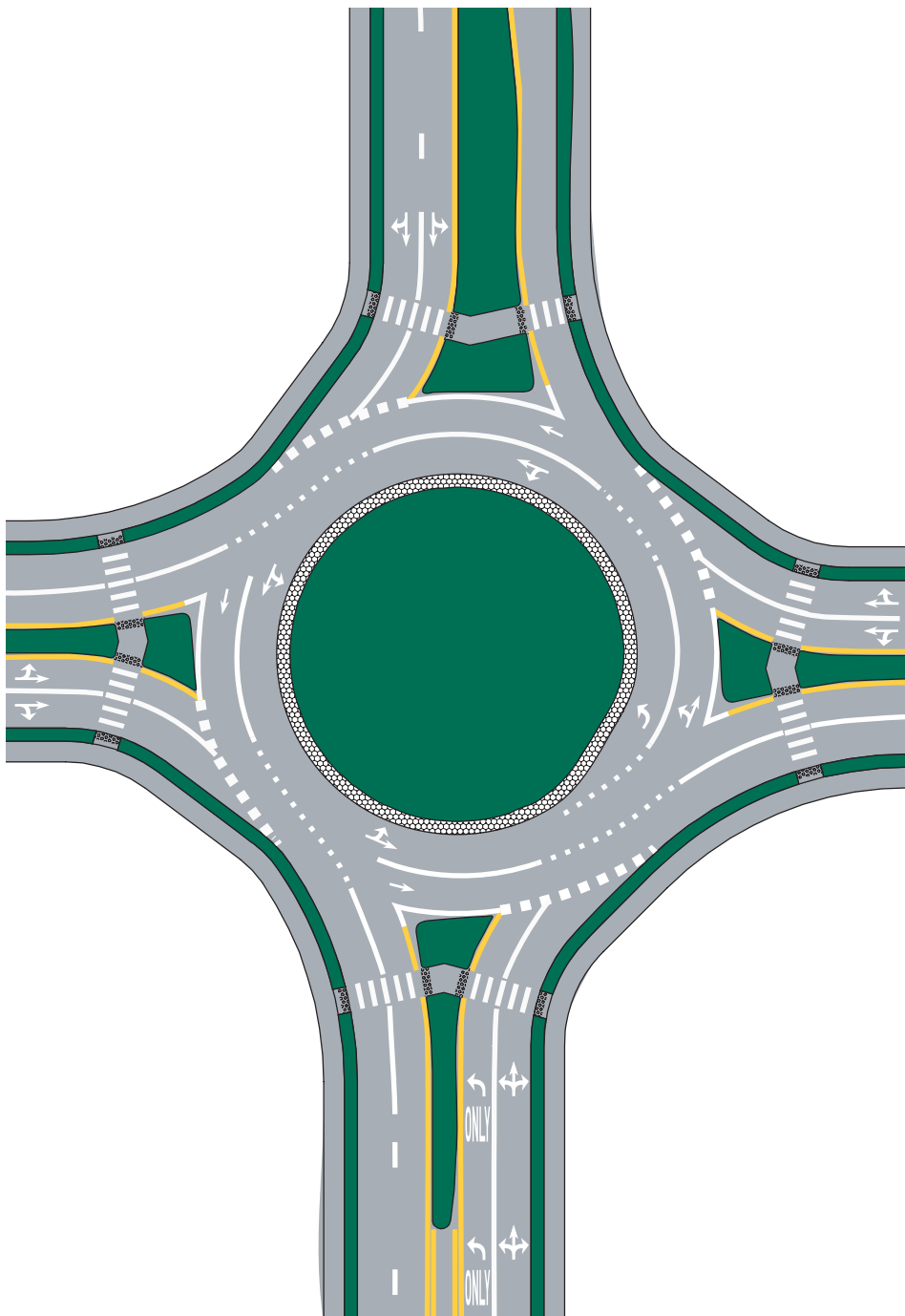
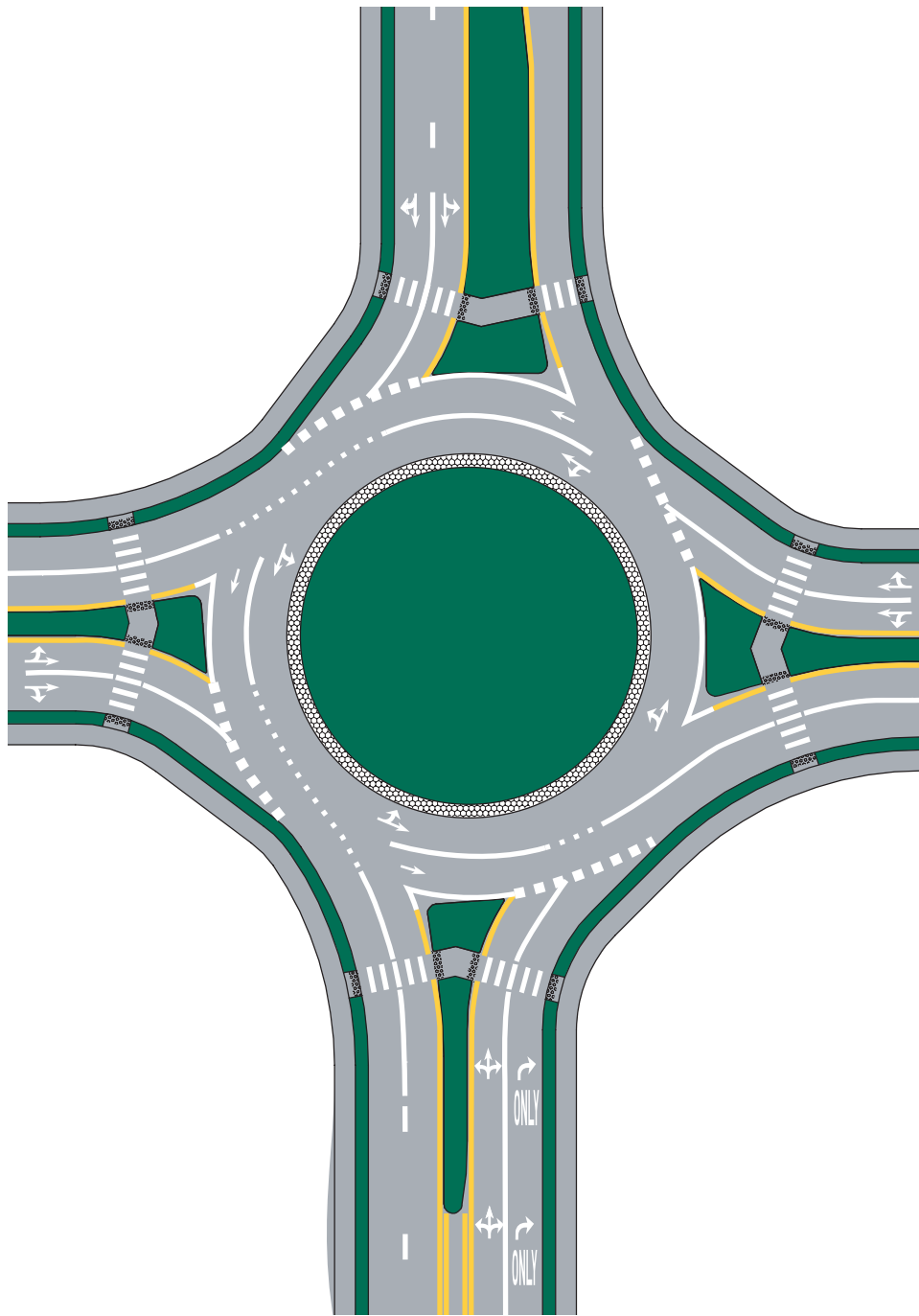

Exhibit A-8
Example Markings for a
Double-Lane Roundabout
with Double Left-Turn Lane

Roundabouts: An Informational Guide

Exhibit A-9
Example Markings for a
Double-Lane Roundabout
with Double Right-Turn Lane



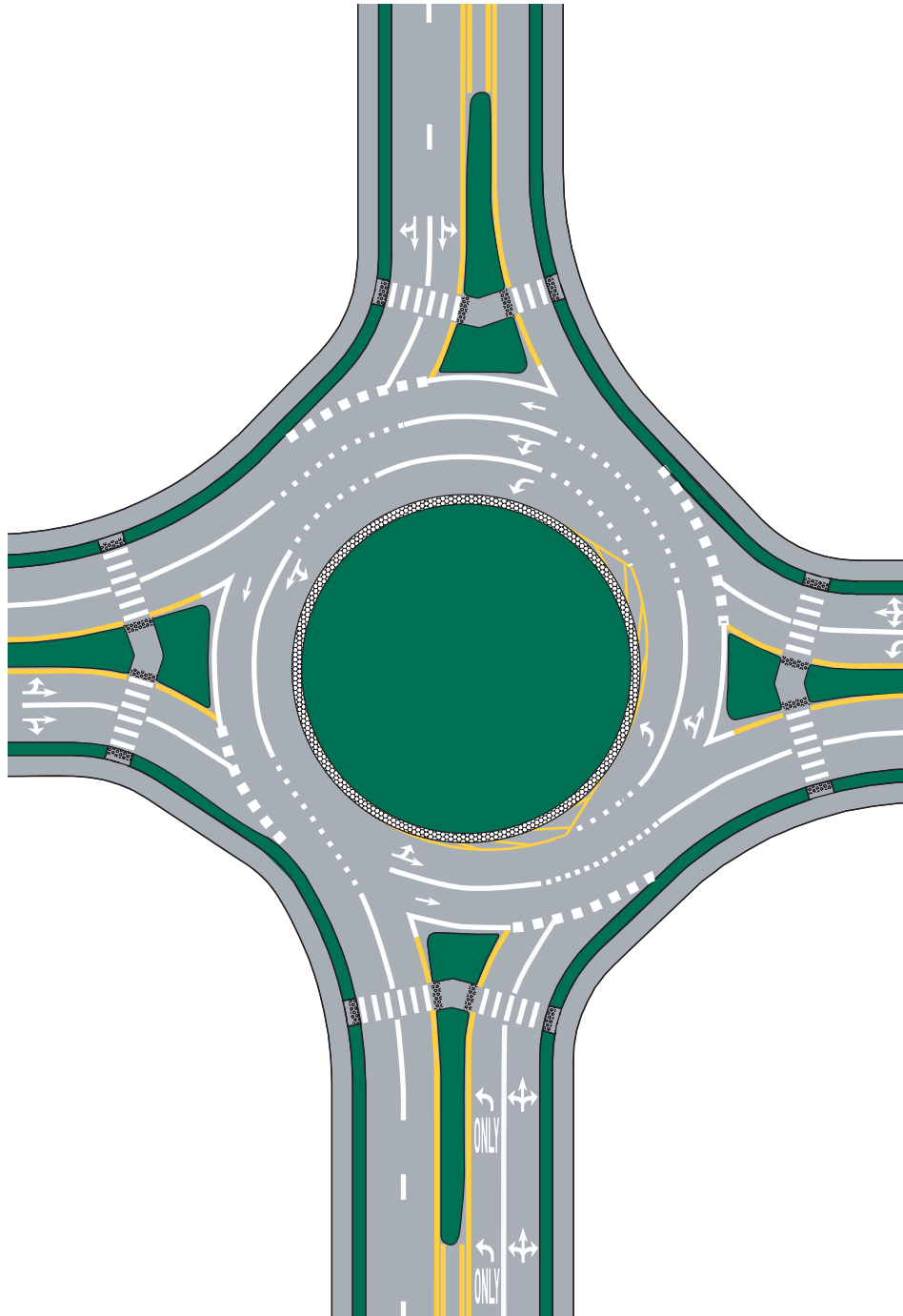
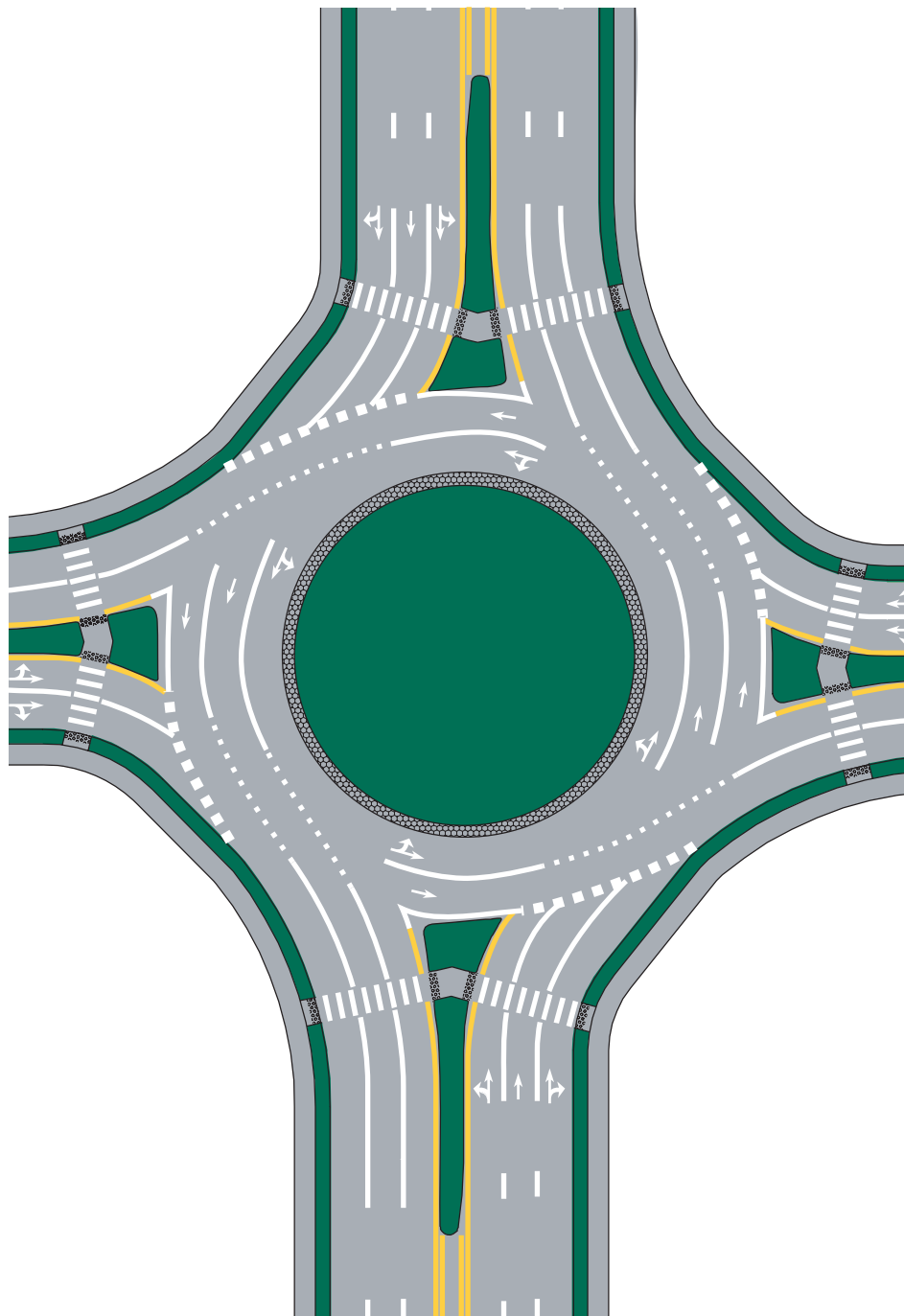

Exhibit A-10
 Example Markings for a
 Double-Lane Roundabout
 with Consecutive Double
 Left Turns

This example shows that in some situations with unusual lane assignment, it may be necessary to increase the number of lanes within the circulatory roadway for the sole purpose of achieving the goal of allowing drivers to choose the appropriate lane on the approach and follow that lane to their desired exit.

Roundabouts: An Informational Guide

Exhibit A-11
Example Markings for a
Three-Lane Roundabout
with Two- and
Three-Lane Approaches



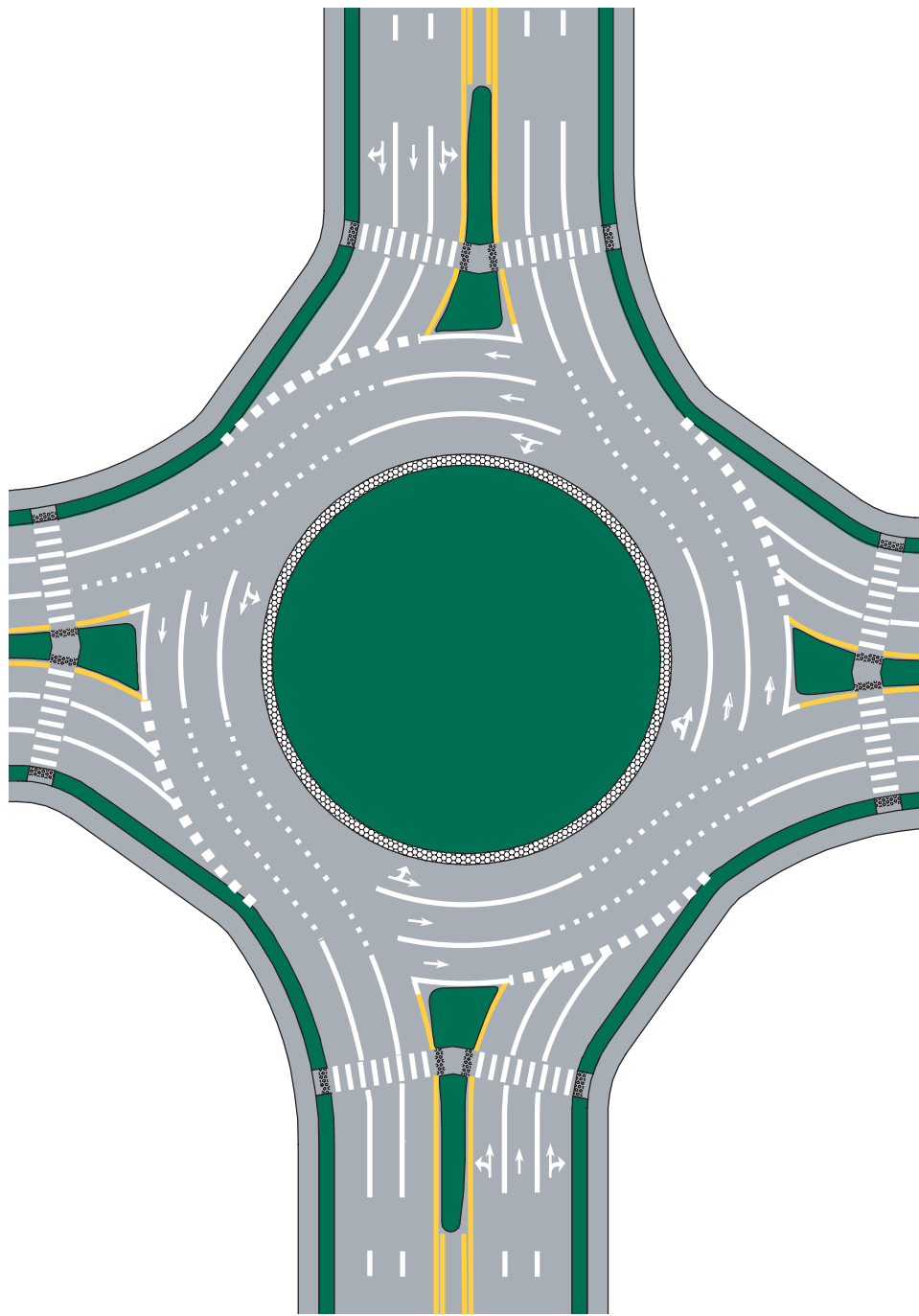

Exhibit A-12
Example Markings for a
Three-Lane Roundabout with
Three-Lane Approaches

Roundabouts: An Informational Guide

Exhibit A-13
Example Markings for a
Three-Lane Roundabout with
Two-Lane Exits and Double
Left Turns on All Approaches

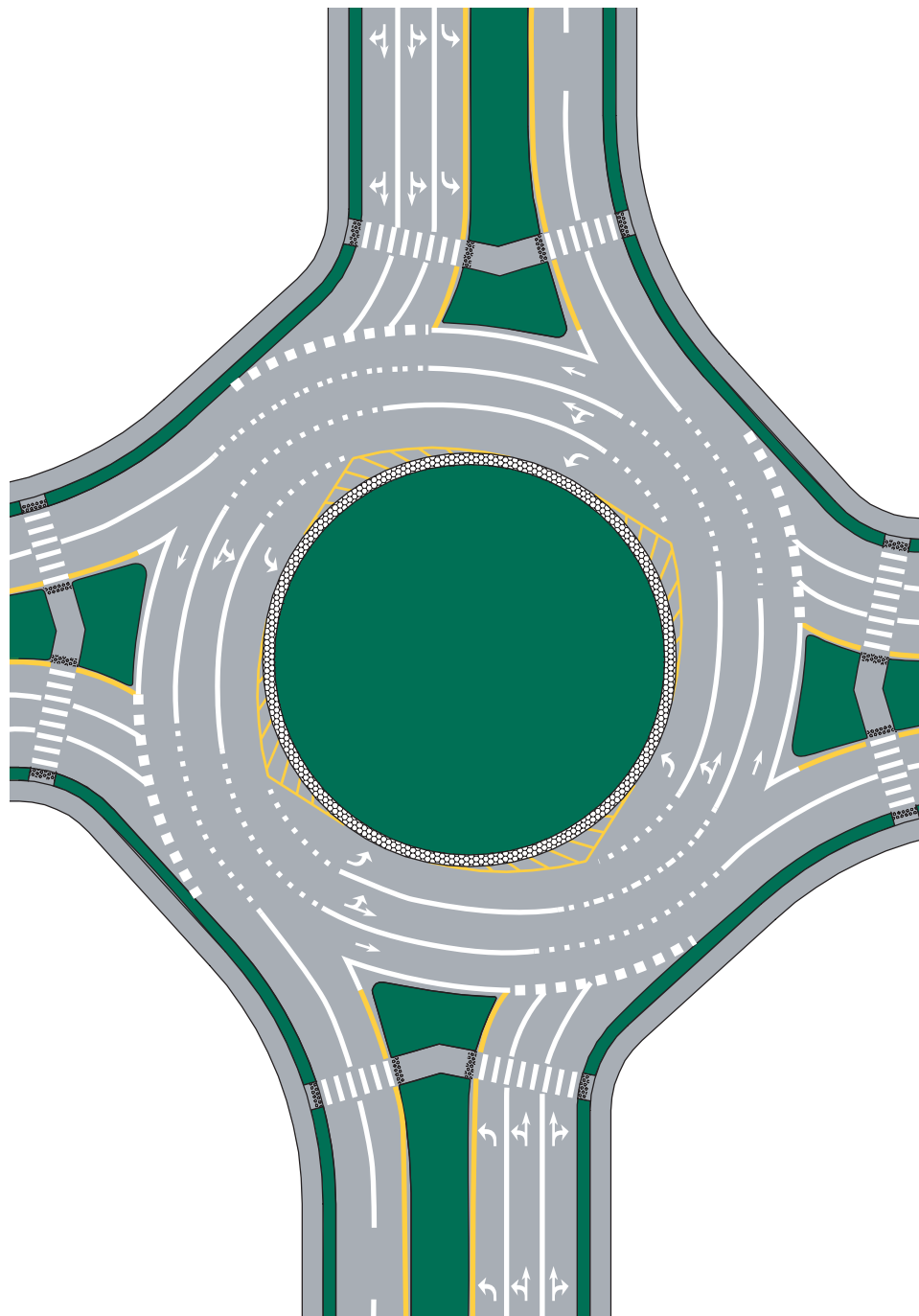
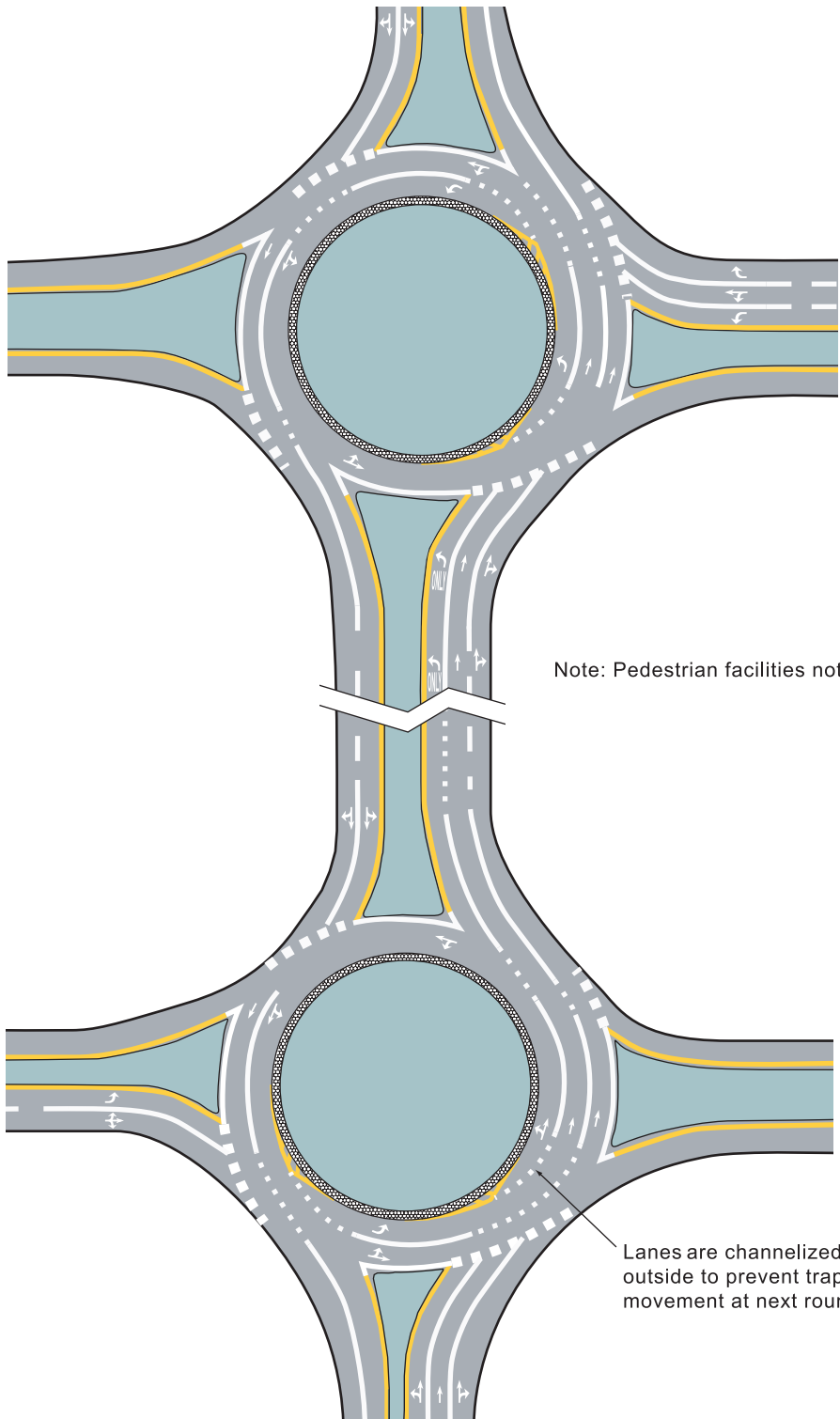

Exhibit A-14
Example Markings for Two
Linked Roundabouts



Note: Pedestrian facilities not shown.

Lanes are channelized to the outside to prevent trapping movement at next roundabout.

Roundabouts: An Informational Guide

Exhibit A-15
Example Markings for a
Diamond Interchange with
Two Circular-Shaped
Roundabout Ramp Terminals

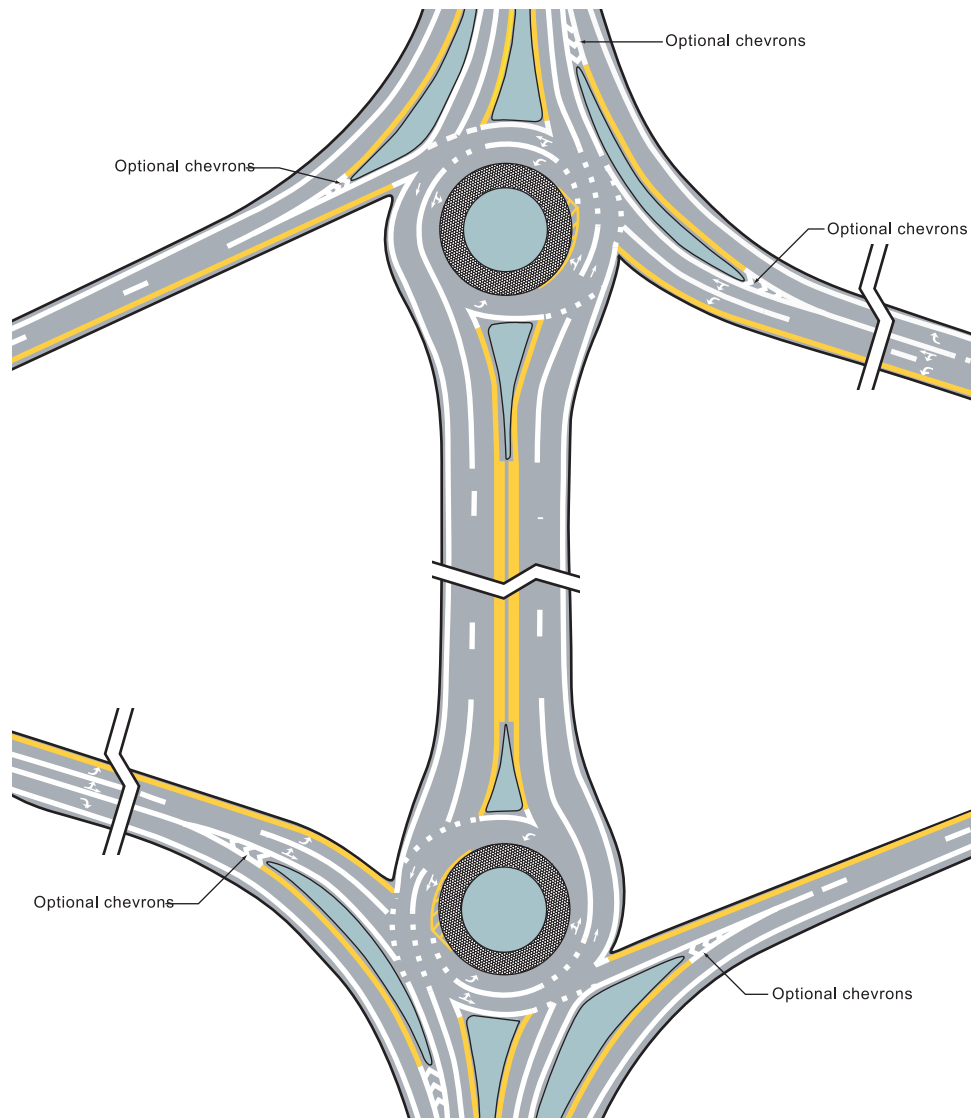

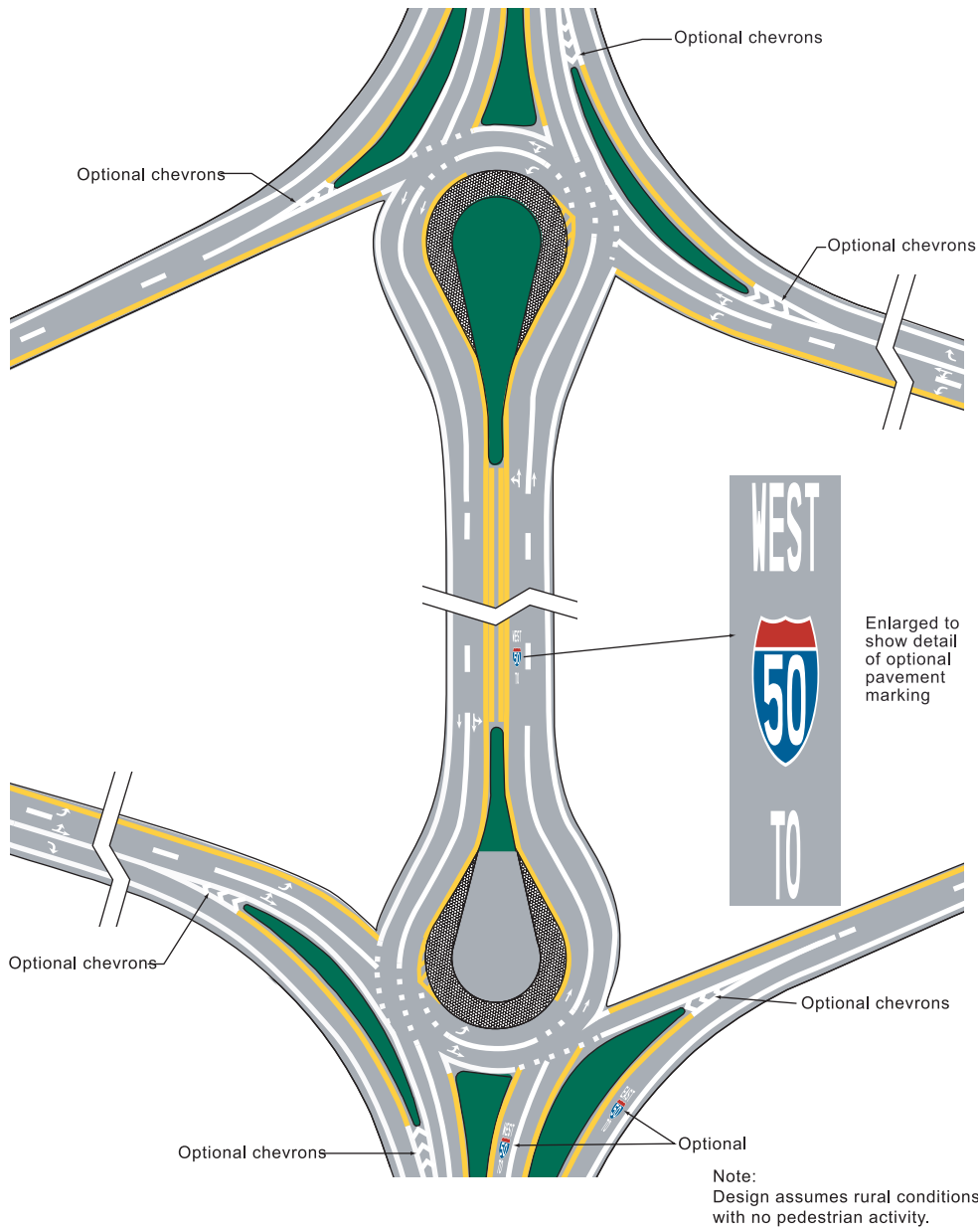

Exhibit A-16
Example Markings for a
Diamond Interchange with
Two Raindrop-Shaped
Roundabout Ramp
Terminals

**APPENDIX B
USER EDUCATION**

CONTENTS

B.1 USING A ROUNDABOUT AS A DRIVER B-3
 B.1.1 General Procedure B-3
 B.1.2 Special Considerations for Drivers B-4

B.2 USING A ROUNDABOUT AS A PEDESTRIAN B-5

B.3 USING A ROUNDABOUT AS A CYCLIST B-6

B.4 REFERENCES B-6

LIST OF EXHIBITS

Exhibit B-1 Vehicular Movements at a Roundabout B-4

B.1 USING A ROUNDABOUT AS A DRIVER

B.1.1 GENERAL PROCEDURE

- Select the appropriate lane for your intended destination before you enter the roundabout:
 - *Turning right:* Unless posted otherwise, use only the right-hand lane if there are multiple approach lanes. Use your right-turn signal. See Exhibit B-1(a).
 - *Going straight ahead:* Unless posted otherwise, you may use any lane to go through. Do not use any turn signals on approach. See Exhibit B-1(b).
 - *Turning left or making a U-turn:* Unless posted otherwise, use the left-hand lane if there are multiple approach lanes. Use your left-turn signal. See Exhibit B-1(c).
- Reduce your speed.
- Keep to the right of the splitter island.
- Watch for bicyclists merging into the roadway from a bicycle lane or shoulder. Bicyclists making left turns may be merging over to the leftmost entry lane.
- Watch for and yield to pedestrians in the crosswalk or waiting to cross.
- Move up to the yield line and wait for an acceptable gap in traffic. Do not enter next to someone already in the roundabout, as that vehicle may be exiting at the next exit.
- Within the roundabout, you do not have to stop except to avoid a collision; you have the right-of-way over entering traffic. Always keep to the right of the central island, and travel in a counterclockwise direction.
- Maintain your position relative to other vehicles. Stay to the inside if you entered from the left lane, or stay to the outside if you entered from the right lane. Do not overtake other vehicles or bicyclists when in the roundabout.
- When you have passed the last exit before the one you want, use your right-turn signal and continue to use your right-turn signal through your exit. Maintain a slow speed.
- Watch for and yield to pedestrians in the crosswalk or waiting to cross.

 Roundabouts: An Informational Guide

Exhibit B-1
Vehicular Movements
at a Roundabout

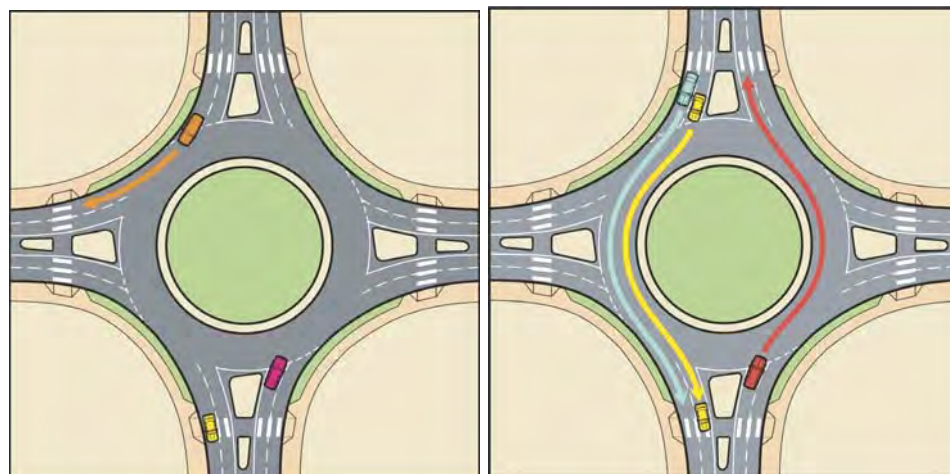

(a) Turning right

(b) Going straight through

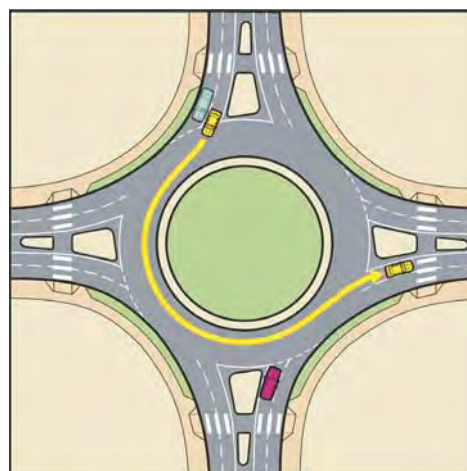

(c) Turning left

Source: Kansas Roundabout Guide (1)

B.1.2 SPECIAL CONSIDERATIONS FOR DRIVERS

- *Motorcyclists and cyclists:* Give them plenty of room. Bicyclists may merge into the approach lanes from a bicycle lane or shoulder. Bicyclists may mistakenly keep to the right on the roundabout; in this case, be aware of their position as you exit the roundabout. It is best to treat bicyclists as other vehicles and not pass them while on the circulatory roadway. Well-designed, low-speed, single-lane roundabouts should not present much difficulty to bicyclists. Keep in mind that drivers should be traveling at about 15–20 miles per hour, close to the speed of bicycles.
- Motorcyclists should not ride across the mountable truck apron next to the central island, if present.
- *Large vehicles (as a driver near a large vehicle):* Do not overtake large vehicles (for example, trucks and buses). Large vehicles may have to swing wide on the approach or within the roundabout. Watch for their turn signals

and give them plenty of room, especially since they may obscure other conflicting users.

- *Large vehicles (as a driver of a large vehicle):* You may need to use the full width of the roadway, including mountable aprons if provided. Be careful of all other users of the roundabout. Prior to entering the roundabout, you may need to occupy both lanes. Signal your intentions well in advance, and satisfy yourself that other users are aware of you and are giving you consideration.
- *Emergency vehicles:* Do not enter a roundabout when an emergency vehicle is approaching on another leg. This will allow traffic within the roundabout to clear in front of the emergency vehicle. When an emergency vehicle is approaching, be sure to proceed beyond the splitter island of your approach leg to ensure the emergency vehicle has adequate room to turn and exit the roundabout at any approach.

B.2 USING A ROUNDABOUT AS A PEDESTRIAN

Pedestrians have the right-of-way within crosswalks at a roundabout; however, pedestrians must not suddenly leave a curb or other safe waiting place and walk into the path of a vehicle if it is so close that it is an immediate hazard. Identifying gaps in the appropriate time to enter can be problematic for pedestrians who are blind or have low vision. Specific education beyond these general instructions may need to be provided for pedestrians with vision impairments to use the minimal information provided for them.

- Do not cross the circulatory roadway to the central island. Walk around the perimeter of the roundabout.
- Cross only at the designated crosswalks. If there is no crosswalk marked on a leg of the roundabout, cross the leg about one vehicle-length away [20 ft (6 m)] from the circulatory roadway of the roundabout.
- Look to the left and listen for approaching traffic. Choose a safe time to cross from the curb ramp to the opening in the raised median between the entry and exit lanes. Although drivers are required to yield to pedestrians in the crosswalk, if approaching vehicles are present it is prudent to first satisfy yourself that conflicting vehicles have recognized your presence and right to cross through visual or audible cues, such as vehicle deceleration or driver communication. If a vehicle slows for you to cross, be sure that any vehicles in adjacent lanes have done likewise before crossing into the next lane.
- Most roundabouts provide a raised median island halfway across the roadway; wait in the opening provided and use the techniques described above to look to the right and choose a safe time to cross the second half of the roadway.

B.3 USING A ROUNDABOUT AS A CYCLIST

At most roundabouts you have the option of traveling through the roundabout like other vehicles or traveling through like a pedestrian:

- **Like other vehicles:** If you are comfortable riding in traffic, ride through the roundabout in the same manner as other vehicles. Obey all of the driving instructions provided for drivers. On the approach to the roundabout, you should merge out of any bicycle lane or shoulder into the roundabout entry lane, in line with other vehicles. When making a left turn at a multi-lane roundabout, you will need to merge into the left lane with other left-turning vehicles. Right-turning cyclists may keep to the right side of the entry lane; others should be near the center of the lane. When circulating, watch out for entering vehicles as some entering drivers may not notice bicyclists because they are inappropriately focused on larger vehicles. Watch out for large vehicles on the roundabout, as they need more space to maneuver. It may be safer to wait until they have cleared the roundabout. If you do not feel comfortable “taking the lane,” then your best solution is to travel through the roundabout like a pedestrian.
- **Travel like a pedestrian:** If you are uncomfortable riding in traffic, dismount and exit the approach lane and move to the sidewalk. At some roundabouts, special bicycle ramps are provided to allow bicyclists to exit the roadway to the sidewalk. In some places, it is illegal to ride your bicycle on the sidewalk; in this case, once on the sidewalk, you should walk your bicycle like a pedestrian. Where it is legal to ride on the sidewalk, you should yield to pedestrians and take extreme care when crossing the exit and entry roadways in the crosswalk. Even where it is legal to ride in crosswalks, it is best to dismount and walk your bike across. Motorists do not expect fast-moving bicyclists in crosswalks. If a ramp is provided to re-enter the roadway, you should verify that it is safe to do so before traveling down the ramp.

B.4 REFERENCES

1. Kittelson & Associates, Inc., and TranSystems Corporation. *Kansas Roundabout Guide: A Supplement to FHWA’s Roundabouts: An Informational Guide*. Kansas Department of Transportation, Topeka, Kansas, 2003.

**APPENDIX C
RULES OF THE ROAD**

CONTENTS

C.1 RULES OF THE ROAD C-2

- C.1.1 Definition of “Intersection” C-2
- C.1.2 Right-of-Way between Vehicles C-3
- C.1.3 Required Lane Position at Intersections C-3
- C.1.4 Priority within the Circulatory Roadway C-3
- C.1.5 Pedestrians C-4
- C.1.6 Parking C-4

C.2 EXAMPLE LEGISLATIVE ACTION C-5

C.3 REFERENCES C-5

C.1 RULES OF THE ROAD

The following sections discuss several of the important legal issues that should be considered for roundabouts. These have been based on the provisions of the 2000 Uniform Vehicle Code (1), which has been adopted to varying degrees by each state, as well as examples from various states and international legislation on roundabouts. Note that the information in the following sections does not constitute specific legal opinion; each jurisdiction should consult with its attorneys on specific legal issues.

C.1.1 DEFINITION OF “INTERSECTION”

The central legal issue around which all other issues are derived is the relationship between a roundabout and the legal definition of an “intersection.” A roundabout could be legally defined one of two ways:

- As a single intersection or
- As a series of T-intersections.

The UVC does not provide clear guidance on the appropriate definition of an intersection with respect to roundabouts. The UVC generally defines an intersection as the area bounded by the projection of the boundary lines of the approaching roadways (UVC §1-46a). It also specifies that where a highway includes two roadways 30 ft (9.1 m) or more apart, each crossing shall be regarded as a separate intersection (UVC §1-146b). This may imply that most circular intersections should be regarded as a series of T-intersections. This distinction has ramifications in the interpretation of the other elements identified in this section.

Some states have codified the legal definition of a roundabout. For example, the State of Oregon has defined a roundabout as follows:

“Roundabout” means an intersection characterized by a circulatory roadway, channelized approaches and yield control of entering traffic. A roundabout encompasses the area bounded by the outermost curb line or, if there is no curb, the edge of the pavement, and includes crosswalks on any entering or exiting roadway. (2)

Furthermore, the State of Oregon has defined the circulatory roadway as follows:

“Circulatory roadway” means the portion of a highway within a roundabout that is used by vehicles to travel counterclockwise around a central island. A circulatory roadway does not have a crosswalk. (3)

This guide recommends that a roundabout be specifically defined as a single intersection, regardless of the size of the roundabout. This intersection should be defined as the area bounded by the limits of the pedestrian crossing areas around the perimeter of a single central island. Closely spaced roundabouts with multiple central islands should be defined as separate intersections since each roundabout is typically designed to operate independently.

Roundabouts are recommended to be defined as a single intersection; the area bounded by the limits of the pedestrian crossing areas.

C.1.2 RIGHT-OF-WAY BETWEEN VEHICLES

The UVC specifies that “when two vehicles approach or enter an intersection from different highways at approximately the same time, the driver of the vehicle on the left shall yield the right-of-way to the vehicle on the right” (UVC §11-401). This runs contrary to the default operation of a roundabout, which assigns the right-of-way to the vehicle on the left and any vehicle in front. This requires the use of yield signs and yield lines at all approaches to a roundabout to clearly define right-of-way.

This guide recommends that right-of-way at a roundabout be legally defined such that an entering vehicle shall yield the right-of-way to the vehicle on the left. This definition does not change the recommendation for appropriately placed yield signs and yield lines.

C.1.3 REQUIRED LANE POSITION AT INTERSECTIONS

At a typical intersection with multilane approaches, vehicles are required by the UVC to use the right-most lane to turn right and the left-most lane to turn left, unless specifically signed or marked lanes allow otherwise (e.g., double left-turn lanes) (UVC §11-601). Because multilane roundabouts can be used at intersections with more than four legs, the concept of “left turns” and “right turns” becomes more difficult to legally define. The following language (1) is recommended:

Unless official traffic control devices indicate otherwise, drivers must make lane choices according to the following rules:

- *If a driver intends to exit the roundabout less than halfway around it, the right lane must be used.*
- *If a driver intends to exit the roundabout more than halfway around it, the left lane must be used.*

The Australian Road Rules (2008) Traffic Act (4) gives no guidance for straight through movements (movements leaving the roundabout exactly halfway), and the general Australian practice is to allow drivers to use either lane unless signed or marked otherwise. On multilane roundabouts, when the intersecting roadways are not at 90° angles or there are more than four legs to the roundabout, special consideration should be given to assisting driver understanding through advance diagrammatic guide signs or lane markings on approaches showing the appropriate lane choices.

C.1.4 PRIORITY WITHIN THE CIRCULATORY ROADWAY

For multilane roundabouts, the issue of priority within the circulatory roadway is important, as it directly affects the exit—circulating conflict. Any vehicle on the inside lane of the circulatory roadway (e.g., a vehicle making a left turn) ultimately needs to exit. This may cause conflicts with other vehicles in the circulatory roadway.

In the United States, this issue is generally addressed through the use of circulatory roadway striping that guides vehicles toward the correct exit (see Chapter 7). In this manner, lane selection takes place before entering the intersection. Any

Because of yield-to-the-right laws, yield signs and lines must be used on roundabout entries to assign right-of-way to the circulatory roadway.

lane changes that take place within the roundabout clearly put the onus on the driver changing lanes to yield the right-of-way to conflicting vehicles. Therefore, the use of circulatory roadway markings as recommended makes the issue of overtaking within the circulatory roadway or priority between circulating and exiting vehicles largely moot.

For unmarked, multilane roundabouts, the issue is less clear. Due to its common use of unmarked multilane roundabouts, the United Kingdom requires drivers to “watch out for traffic crossing in front of you on the roundabout, especially vehicles intending to leave by the next exit. Show them consideration” (5, §125). This is generally interpreted as meaning that a vehicle at the front of a group of vehicles within the circulatory roadway has the right-of-way, regardless of the track it is on, and following vehicles on any track must yield to the front vehicle as it exits.

C.1.5 PEDESTRIANS

The legal definition of a roundabout as one intersection or a series of intersections also has implications for pedestrians, particularly with respect to marked and unmarked crosswalks. A portion of the UVC definition of a crosswalk is as follows: “. . . in the absence of a sidewalk on one side of the roadway, that part of a roadway included within the extension of the lateral lines of the existing sidewalk at right angles to the centerline” [UVC §1-118(a)]. Under the definition of a roundabout as a series of T-intersections, this portion of the definition could be interpreted to mean that there are unmarked crosswalks between the perimeter and the central island at every approach. The recommended definition of a roundabout as a single intersection simplifies this issue, for the marked or unmarked crosswalks around the perimeter as defined are sufficient and complete. This is also another reason to provide landscaping between sidewalks and the circulatory roadway; it is more difficult to make a legal argument that crosswalks exist across the circulatory roadway if the sidewalks do not extend to the edge of the circulatory roadway.

In all states, drivers are required to either yield or stop for pedestrians in a crosswalk, including crosswalks at roundabouts.

C.1.6 PARKING

Many states prohibit parking within a specified distance of an intersection; others allow parking right up to the crosswalk. The degree to which these laws are in place will govern the need to provide supplemental signs and/or curb markings showing parking restrictions. This guide recommends that parking be restricted immediately upstream of the pedestrian crosswalks to provide the necessary sight distances for safe crossings to occur.

The legal need to mark parking restrictions within the circulatory roadway may be dependent on the definition of a roundabout as a single intersection or as a series of T-intersections. Using the recommended definition of a roundabout as a single intersection, the circulatory roadway would be completely contained within the intersection, and the UVC currently prohibits parking within an intersection (UVC §11-1003).

C.2 EXAMPLE LEGISLATIVE ACTION

In addition to the definitions described previously, the State of Oregon added language to the Oregon Vehicle Code in 2001 to address right-of-way and the use of turn signals as follows:

811.292. Failure to yield right-of-way within roundabout; exception; penalty. (1) A person commits the offense of failure to yield right-of-way within a roundabout if the person operates a motor vehicle upon a multilane circulatory roadway and does not yield the right-of-way to a second vehicle lawfully exiting the roundabout from a position ahead and to the left of the person's vehicle. (2) This section does not apply if a traffic control device indicates that the operator of a motor vehicle should take other action. (3) The offense described in this section, failure to yield right-of-way within a roundabout, is a Class C traffic violation. (2001 c.464 §5)

811.400. Failure to use appropriate signal for turn, lane change, stop, or exit from roundabout; penalty. (1) A person commits the offense of failure to use an appropriate signal for a turn, lane change, or stop or for an exit from a roundabout if the person does not make the appropriate signal under ORS 811.395 by use of signal lamps or hand signals and the person is operating a vehicle that is: (a) Turning, changing lanes, stopping, or suddenly decelerating; or (b) Exiting from any position within a roundabout. (2) This section does not authorize the use of only hand signals to signal a turn, change of lane, stop, or deceleration when the use of signal lights is required under ORS 811.405. (3) The offense described in this section, failure to use appropriate signal for a turn, lane change, or stop or for an exit from a roundabout, is a Class B traffic violation. (1983 c.338 §634; 1995 c.383 §66; 2001 c.464 §6)

C.3 REFERENCES

1. National Committee on Uniform Traffic Laws and Ordinances (NCUTLO). Uniform Vehicle Code and Model Traffic Ordinance. Evanston, Illinois: NCUTLO, 2000.
2. State of Oregon. Oregon Revised Statute 801.451. <http://www.leg.state.or.us/ors/801.html>. Accessed March 2010.
3. State of Oregon. Oregon Revised Statute 801.187. <http://www.leg.state.or.us/ors/801.html>. Accessed March 2010.
4. Australia. Traffic Act, Part 6A, 1962.
5. Department of Transport (United Kingdom). The Highway Code. Department of Transport and the Central Office of Information for Her Majesty's Stationery Office, 1996.

**APPENDIX D
DESIGN SUPPLEMENTAL MATERIALS**

CONTENTS

D.1 DESIGN APPENDIX D-3

D.2 REFERENCES D-3

LIST OF EXHIBITS

Exhibit D-1 Side Friction Factors at Various Speeds D-3

D.1 DESIGN APPENDIX

The relationship between travel speed and horizontal curvature is documented in the AASHTO *Policy on Geometric Design of Highways and Streets (1)*. Equation D-1 can be used to calculate the design speed for a given travel path radius.

$$V = \sqrt{15R(e + f)}$$

Equation D-1

where:

- V = design speed, mph;
- R = radius, ft;
- e = superelevation, ft/ft; and
- f = side friction factor.

Superelevation values are usually assumed to be +0.02 for entry and exit curves and –0.02 for curves around the central island. Values for side friction factor can be determined in accordance with AASHTO standards for curves at intersections [see AASHTO Exhibit 3-11 (1)]. The coefficient of friction between a vehicle's tires and the pavement varies with speed, as shown in Exhibit D-1.

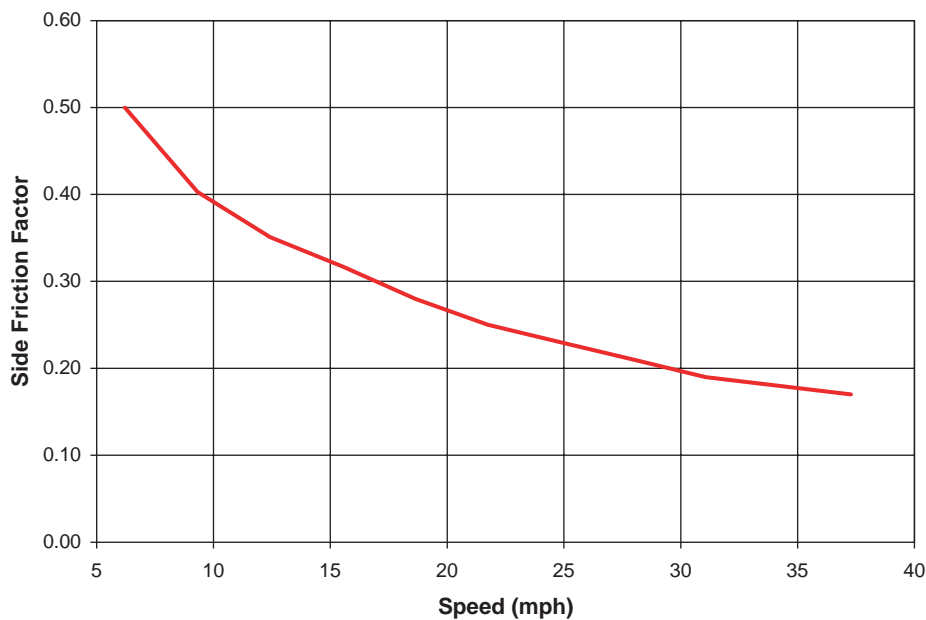

Exhibit D-1
Side Friction Factors at Various Speeds

D.2 REFERENCE

1. *A Policy on Geometric Design of Highways and Streets*. AASHTO, Washington, D.C., 2004.

Abbreviations and acronyms used without definitions in TRB publications:

AAAE	American Association of Airport Executives
AASHO	American Association of State Highway Officials
AASHTO	American Association of State Highway and Transportation Officials
ACI-NA	Airports Council International–North America
ACRP	Airport Cooperative Research Program
ADA	Americans with Disabilities Act
APTA	American Public Transportation Association
ASCE	American Society of Civil Engineers
ASME	American Society of Mechanical Engineers
ASTM	American Society for Testing and Materials
ATA	Air Transport Association
ATA	American Trucking Associations
CTAA	Community Transportation Association of America
CTBSSP	Commercial Truck and Bus Safety Synthesis Program
DHS	Department of Homeland Security
DOE	Department of Energy
EPA	Environmental Protection Agency
FAA	Federal Aviation Administration
FHWA	Federal Highway Administration
FMCSA	Federal Motor Carrier Safety Administration
FRA	Federal Railroad Administration
FTA	Federal Transit Administration
HMCRP	Hazardous Materials Cooperative Research Program
IEEE	Institute of Electrical and Electronics Engineers
ISTEA	Intermodal Surface Transportation Efficiency Act of 1991
ITE	Institute of Transportation Engineers
NASA	National Aeronautics and Space Administration
NASAO	National Association of State Aviation Officials
NCFRP	National Cooperative Freight Research Program
NCHRP	National Cooperative Highway Research Program
NHTSA	National Highway Traffic Safety Administration
NTSB	National Transportation Safety Board
PHMSA	Pipeline and Hazardous Materials Safety Administration
RITA	Research and Innovative Technology Administration
SAE	Society of Automotive Engineers
SAFETEA-LU	Safe, Accountable, Flexible, Efficient Transportation Equity Act: A Legacy for Users (2005)
TCRP	Transit Cooperative Research Program
TEA-21	Transportation Equity Act for the 21st Century (1998)
TRB	Transportation Research Board
TSA	Transportation Security Administration
U.S.DOT	United States Department of Transportation