

自动安平水准仪 Automatic Level

使用手册

DAL20-32H系列

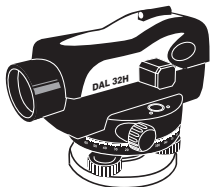

DAL20-32P系列

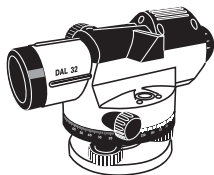
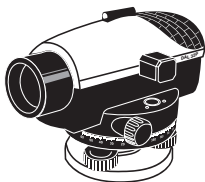

DAL20-32系列

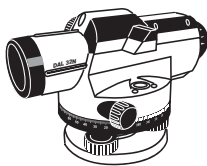

DAL20-32N系列

INSTRUCTION MANUAL



前言

感谢您购买本公司生产的自动安平水准仪,为了充分发挥仪器的性能,请您仔细阅读本手册并妥善保管,以备日后参考。

注意事项:

- ❑ 操作仪器之前或经过长时间的运输之后,都必须检查测量仪器的找平精度和显示精度。
- ❑ 不可以让湿气渗入仪器中,也不可以让阳光直接照射在仪器上。
- ❑ 仪器不可以长期放置在汽车中。
- ❑ 若仪器工作处的温度与存放处的温度差异太大,应先将仪器留在箱内,直至它适应环境温度后再使用。
- ❑ 仪器不可以曝露在极端的气候下,会影响仪器的测量准确度。
- ❑ 应避免任何冲撞或让测量仪器掉落在地面上。
- ❑ 长途运输仪器时,必须把仪器放置在仪器箱内。运输时应小心避免挤压、碰撞和剧烈震动。
- ❑ 本仪器只能交给合格的专业人员修理,而且只能使用原厂的备件。非专业人员不可擅自拆开仪器,以免发生不必要的损坏。

1. 技术参数.....	1
1.1 DAL20-32系列及DAL20-32N系列技术参数.....	1
1.2 DAL20-32P系列及DAL20-32H系列技术参数.....	2
2. 仪器各部件名称.....	3
3. 仪器使用.....	4
3.1 仪器安置.....	4
3.2 瞄准与调焦.....	4
4. 测量功能.....	5
4.1 测量高差.....	5
4.2 测量距离.....	6
4.3 角度测量.....	6
5. 仪器的检查与调整.....	7
5.1 圆水泡检查.....	7
5.2 圆水泡校正.....	7
5.3 i角检查.....	7
5.4 i角校正.....	9
6. 仪器的维护与保养.....	9
7. 装箱单.....	9

1. 技术参数

1.1 DAL20-32系列及DAL20-32N系列技术参数

DAL20-32系列 | DAL20-32N系列

倍 率	20X	22X	24X	26X	28X	32X
工作范围	60m	90m	90m	105m	105m	120m
单一测量时的高度精度	3mm/30m	3mm/30m	1.6mm/30m	1.6mm/30m	1.6mm/30m	1.6mm/30m
物镜口径	36mm	36mm	36mm	36mm	36mm	36mm
安平精度	±0.8"	±0.8"	±0.8"	±0.5"	±0.5"	±0.3"
每公里往返测量标准偏差	2.5mm	2.0mm	2.0mm	1.5mm	1.5mm	1.0mm
望 远 镜	正像					
最短视距	0.3m					
视 场 角	1°30'					
补偿器工作范围	±15'					
乘 常 数	100					
加 常 数	0					
圆水泡精度	8'/2mm					
度盘分度值	1°或1gon					
防 水	是					
仪器净重	1.8kg					
三角架连接尺寸	M16或5/8"					

1.2 DAL20-32P系列及DAL20-32H系列技术参数

DAL20-32P系列

DAL20-32H系列

倍 率	20X	22X	24X	26X	28X	32X
工作范围	60m	90m	90m	105m	105m	120m
单一测量时的高度精度	3mm/30m	3mm/30m	1.6mm/30m	1.6mm/30m	1.6mm/30m	1.6mm/30m
物镜口径	36mm	36mm	36mm	40mm	40mm	40mm
安平精度	±0.8"	±0.8"	±0.8"	±0.5"	±0.5"	±0.3"
每公里往返测量标准偏差	2.5mm	2.0mm	2.0mm	1.5mm	1.5mm	1.0mm
望 远 镜	正像					
最短视距	0.3m					
视 场 角	1°30'					
补偿器工作范围	±15'					
乘 常 数	100					
加 常 数	0					
圆水泡精度	8'/2mm					
度盘分度值	1°或1gon					
防 水	是					
仪器净重	1.8kg					
三角架连接尺寸	M16或5/8"					

2. 仪器各部件名称

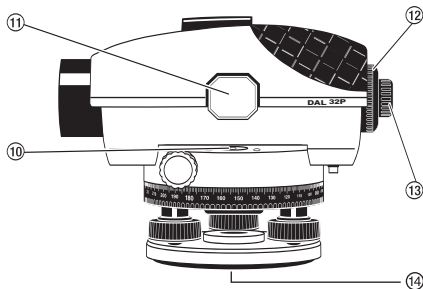
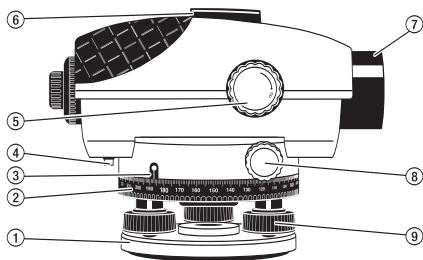

- | | | |
|----------|-------------|--------------------------|
| 1. 底座 | 6. 光学瞄准器 | 11. 水泡观察器 |
| 2. 度盘 | 7. 物镜 | 12. 目镜罩 |
| 3. 度盘指示牌 | 8. 水平循环微动手轮 | 13. 目镜 |
| 4. 补偿器锁 | 9. 脚螺丝手轮 | 14. 5/8" 的三脚架
接头（在下侧） |
| 5. 调焦手轮 | 10. 圆水泡 | |

备注：其它系列水准仪也请参考此页介绍

3. 仪器使用

3.1 仪器安置

1. 将三脚架竖立好，确保它不会翻倒或滑动，并调整至人眼的水平位置。
2. 把测量仪器上的三脚架接头**14**装入三脚架的螺杆中。拧紧三脚架的固定螺丝来固定好测量仪器。
3. 先粗略的进行瞄准工作，在短距离内可以提起三脚架来搬动仪器，为了避免在搬运中损坏仪器，必须以直立的方式提携三脚架，不可以把三脚架横靠在肩上。
4. 使用脚螺丝手轮**9**校准仪器。调整脚螺丝手轮让圆水泡中的气泡位于其中心。（图1）

图1

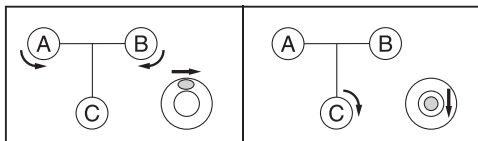

先转动脚螺丝手轮**A**和**B**让气泡移动到这两点中央的位置，接着在转动脚螺丝手轮**C**至气泡移动到圆水泡中心为止。

3.2 瞄准与调焦

1. 拆除物镜**7**上的防护盖，把望远镜对准亮的物体，或者把白纸放在物镜**7**前面，接着在转动目镜**13**至能够清楚地看见深黑色的十字丝为止。
2. 把望远镜对准水准尺，必要时得借助光学瞄准器**6**来瞄准。
3. 转动调焦手轮**5**至能够清楚地看见水准尺上的刻度为止。
4. 旋转水平循环微动手轮**8**，把十字丝移动到水准尺的中央位置。

4. 测量功能

4.1 测量高差

1. 将仪器安置于被测点A、B的中间。(图2)
2. 将水准尺以垂直的方式竖立于A点，将仪器聚焦并把十字丝调整到水准尺的中央，记录下十字丝的中线在水准尺所在位置的刻度值a。(图3)
3. 将水准尺以垂直的方式竖立于B点，将仪器聚焦并把十字丝调整到水准尺的中央，记录下十字丝的中线在水准尺所在位置的刻度值b。(图4)
4. 高差 $h=1.78-1.215=0.565$ 米。



图2



图3

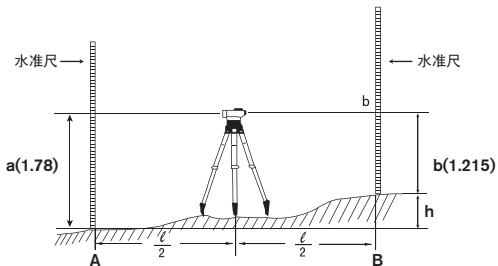

图4

4.2 测量距离

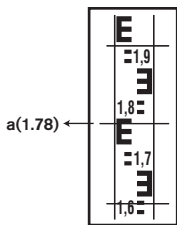
1. 瞄准水准尺，记录下视距丝（图5）在水准尺所在位置的刻度值。（图6）
2. 将视距丝的高度差值乘100，所得的值便是从仪器到水准尺的距离。

图上测得的距离是： $(1.347-1.042) \times 100 = 30.5$ 米

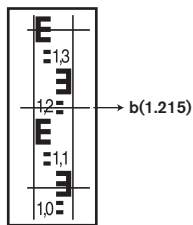

图5



图6

4.3 角度测量

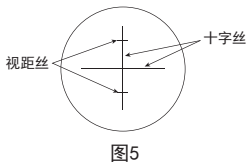
1. 把测量仪器对准点A，转动度盘2让刻度“0”对准度盘指示牌3。（图7）
2. 把测量仪器对准点B，此时记录下度盘指示牌3下的刻度。（图7）

图上测得的角度是： 45°

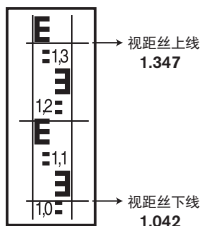

图7

5. 仪器的检查与调整

使用仪器之前或经过长时间的运输之后，都必须检查测量仪器的找平精度和显示精度。

5.1 圆水泡检查

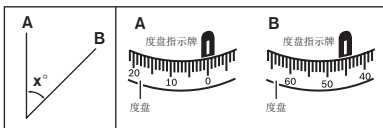
1. 使用脚螺丝手轮**9**校准仪器。调整脚螺丝手轮让气泡位于圆水泡的中心。
2. 将仪器旋转**180°**，气泡应在圆水泡的中心，如果偏离，则需要校正。

5.2 圆水泡校正

1. 旋转脚螺丝手轮**9**，使气泡向中心移动，偏移量为**1/2**。(图8)
2. 使用内六角扳手调整水泡螺钉，使气泡移至圆水泡的中心。(图9)
3. 重复上述步骤，直至望远镜转至任何方向时气泡始终处于圆水泡的中心位置。



图8



图9

5.3 i角检查

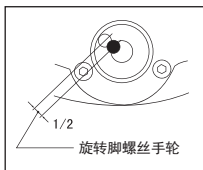
1. 检查时必须找一段**30米**长的测量距离。把仪器放置在中间位置，在测量的两端分别放置水准尺**A**和水准尺**B**。(图10)
2. 分别记录两个水准尺上的高度，计算出差值**d**；即**a1**（水准尺**A**上的高度）和**b1**（水准尺**B**上的高度）的差距。

例子: $a_1=1.937$ 米 $b_1=1.689$ 米 则 $a_1-b_1=0.248$ 米= d

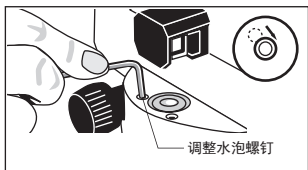

图10

3. 把仪器放置在距离水准尺A约1米处，再记录高度值 a_2 （水准尺A上的高度）。
4. 计算 $b_2'=a_2-d$ ，再记录高度值 b_2 （水准尺B上的高度），如果 b_2' 与 b_2 的差异超过6毫米（20X/22X）或3毫米（24X/26X/28X/32X），则需要校正。

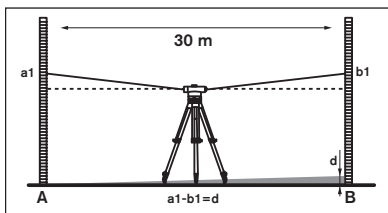

图11

例子: $a_2=1.724$ 米 $d=0.248$ 米 则 $a_2-d=1.476$ 米= b_2'

20X/22X: 测量时，高度 b_2 的值应该是1.476米 \pm 6毫米

24X/26X/28X/32X: 测量时，高度 b_2 的值应该是1.476米 \pm 3毫米

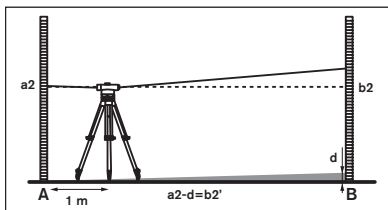
5.4 i角校正

取下目镜罩，使用改正针，朝顺时针或逆时针的方向转动校正螺钉，让水准尺B上的高度测量值**b2**与**b2'**相符为止。

6. 仪器的维护与保养

仪器应精心维护保养，以保证仪器精度及使用效率。

1. 测量工作完成后，将仪器各部表面清洁干净，放入仪器箱内。
2. 光学零件表面使用软毛刷、镜头纸清擦，忌用手指触摸镜片。
3. 仪器如有故障或损坏，须有熟悉仪器结构并有一定修理经验的技术人员进行检修，或送往仪器制造厂修理，禁止擅自打开测量仪器。
4. 仪器箱内备有干燥剂一袋，它能够凝结箱中的湿气，请定时更换干燥剂袋。
5. 仪器应储存于干燥、清洁、通风良好的地方。

7. 装箱单

塑料仪器箱.....	1
测量仪器.....	1
改正针.....	1
内六角扳手.....	1
使用说明书.....	1
铅锤.....	1
干燥剂.....	1

备注：400gon度盘、5/8" 三脚架连接尺寸仅供出口选用。

Preface

We appreciate of your purchasing our autolevel series. In order to help you fully explore the instrument features, please read this manual carefully and save these instructions properly for future reference.

Notes:

- before start to operate the instrument or after long transportation, the leveling and display accuracy must be checked first.
- Protect the instrument against moisture, and keep the instrument away from direct sunshine.
- Never leave the instrument in vehicles for a long time.
- If the temperature has difference between the working spot and reserved place, please keep the instrument into case for a while until it suit to the working temperature before putting into operation.
- The measuring accuracy of the instrument can be impaired if exposing it under extreme temperatures or variations in temperature.
- Avoid of any impact to or dropping of the instrument onto the ground.
- Place the instrument into the provided carrying case during long transportation. The instrument should be avoid of extreme extrusion, bumping and shaking during transportation. Ensure that instrument is correctly placed in the transport case (When placing the instrument into case, the compensator should be locked, otherwise, it could be damaged in case of intense movement.)
- This instrument only allow the qualified specialists to repair and ensure of using the original spare parts. No one allow to separate the unit except of professional to avoid of any unnecessary damaged.

Index

EN

1. Technical Data.....	10
1.1 DAL20-32 Series & DAL20-32N Series technical data.....	10
1.2 DAL20-32P Series & DAL20-32H Series technical data.....	11
2. The instrument parts name.....	12
3. Operation.....	13
3.1 Setting up.....	13
3.2 Aiming and focusing.....	13
4. Measuring function.....	14
4.1 measuring height.....	14
4.2 measuring distance.....	15
4.3 measuring angles.....	15
5. Checking and adjusting instrument.....	16
5.1 checking the circular vial.....	16
5.2 adjusting the circular vial.....	16
5.3 checking i angle.....	16
5.4 adjusting i angle.....	18
6. Maintenance and Service.....	18
7. Packing list.....	18

1. Technical Data

1.1 DAL20-32 series & DAL20-32N series technical data

	DAL20-32 series			DAL20-32N series		
Magnification	20X	22X	24X	26X	28X	32X
Working Range	60m	90m	90m	105m	105m	120m
Height accuracy for an individual measurement	3mm/30m	3mm/30m	1.6mm/30m	1.6mm/30m	1.6mm/30m	1.6mm/30m
Clear objective aperture	36mm					
Compensator setting accuracy	±0.8"	±0.8"	±0.8"	±0.5"	±0.5"	±0.3"
Standard Deviation for 1 km	2.5mm	2.0mm	2.0mm	1.5mm	1.5mm	1.0mm
	double run leveling					
Telescope Image	erect					
Short focusing distance	0.3m					
Field of view	1°30'					
The working range of compensator	±15'					
Stadia ratio	100					
Stadia addition	0					
Accuracy of circular vial	8'/2mm					
Horizontal circle graduation	1° or 1gon					
Water resident	Yes					
Net weight	1.8kg					
Tripod mount thread	M16 or 5/8"					

1.2 DAL20-32P series & DAL20-32H series technical data

	DAL20-32P series	DAL20-32H series
--	------------------	------------------

Magnification	20X	22X	24X	26X	28X	32X
Working Range	60m	90m	90m	105m	105m	120m
Height accuracy for an individual measurement	3mm/30m	3mm/30m	1.6mm/30m	1.6mm/30m	1.6mm/30m	1.6mm/30m
Clear objective aperture	36mm	36mm	36mm	40mm	40mm	40mm
Compensator setting accuracy	±0.8"	±0.8"	±0.8"	±0.5"	±0.5"	±0.3"
Standard Deviation for 1 km	2.5mm	2.0mm	2.0mm	1.5mm	1.5mm	1.0mm
double run leveling						
Telescope Image	erect					
Short focusing distance	0.3m					
Field of view	1°30'					
The working range of compensator	±15'					
Stadia ratio	100					
Stadia addition	0					
Accuracy of circular vial	8'/2mm					
Horizontal circle graduation	1° or 1gon					
Water resident	Yes					
Net weight	1.8kg					
Tripod mount thread	M16 or 5/8"					

2. The instrument parts description

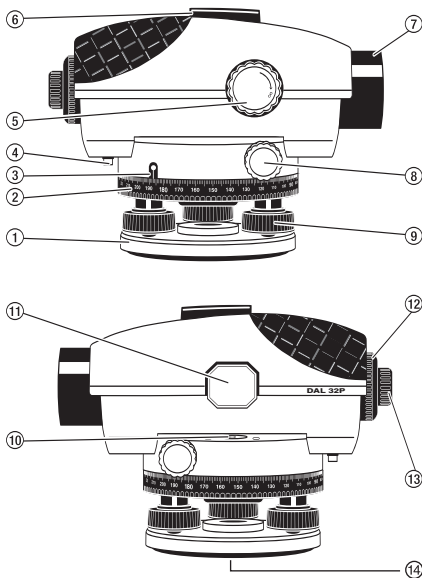

1. base plate

2. horizontal circle

3. horizontal circle reference mark

4. compensator lock

5. focusing adjusting knob

6. optical peep sight

7. objective lens

8. horizontal drive screw

9. leveling screw

10. circular vial

11. bubble observe mirror

12. eyepiece cover

13. eyepieces focusing knob

14. tripod mount 5/8"
(on the rear side)

Other series Autolevel please refer to introduction on this page

3. Operation

3.1 Setting up

1. Set up the tripod stable and safe against tipping over or slipping off, and adjust tripod to the position of user's eyes level.
2. Place the instrument via the tripod mount 14 onto the male thread of the tripod and screw the unit tight with locking screw of the tripod.
3. Roughly level the tripod, over the short distance, the instrument can be carried by lifting the tripod. To ensure that the instrument is not damaged during this process the tripod must be held vertically and should not be lengthwise over the shoulder.
4. Align the instrument with leveling screw 9 so that the air bubble is in the center of the circular vial (see fig.1)

fig.1

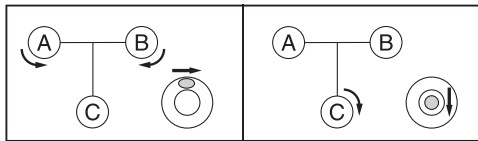

turn the first two leveling screws A and B to move the air bubble so that it is centered between the two leveling screws, then turn the leveling screw C until the air bubble is in the center of circular vial.

3.2 Aiming and focusing

1. take away the objective lens cover 7, let the telescope shoot toward a bright object or hold a white sheet of paper in front of the objective lens 7, then turn the eyepieces 13 till dark black crosshair can be seen sharply.
2. Direct the telescope towards the leveling rod, it may required optical peep sight 6 to aim if necessary.
3. Turn focusing knob 5 till the graduation field of the leveling rod appears sharply.
4. Align the crosshair exactly to the center of the leveling rod by turning the horizontal drive screw 8.

4. Measuring Functions

4.1 Measuring Height

1. Place the instrument to the center of point of A and B (see fig2.)
2. Erect the leveling rod to the point of A vertically, focus the instrument against the leveling rod and adjust the crosshair to match the center of leveling rod, record the height value a of the leveling rod at the centre line of the crosshair. (see fig.3)
3. Erect the leveling rod to the point of B vertically, focus the instrument against the leveling rod and adjust the crosshair to match the center of leveling rod, record the height value b of the leveling rod at the center line of crosshair. (see Fig.4)
4. The Height Difference $h=1.78-1.215=0.565\text{m}$

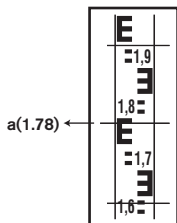
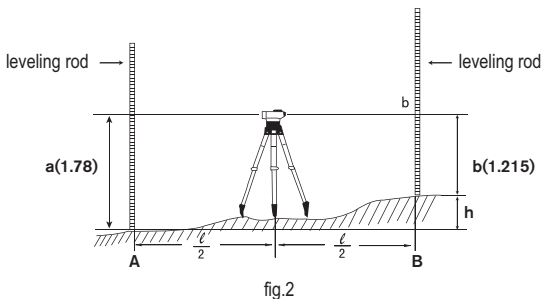

Fig.3

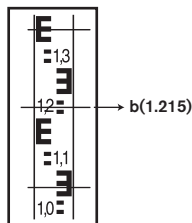

Fig.4

4.2 Measuring Distance

1. Aiming the leveling rod, record the value of upper and lower stadia hair (see fig.5) against the position of leveling rod (see fig.6)
2. Multiply the difference of both heights of stadia hair by 100 to receive the distance value from the leveling rod to the instrument.

distance measured in the figure: $(1.347-1.042) \times 100=30.5\text{m}$

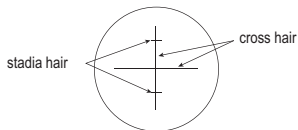

fig.5

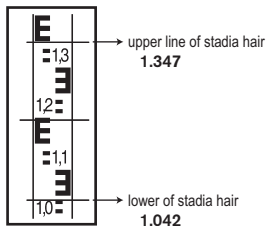

fig.6

4.3 Measuring Angles

1. Shoot the instrument toward A, rotate the horizontal circle 2 with "0" point toward the reference mark 3. (see fig.7)
2. Shoot the instrument toward B, read off the angle value at the reference mark 3 of horizontal circle. (see fig.7)

the measured angle in figure: 45°

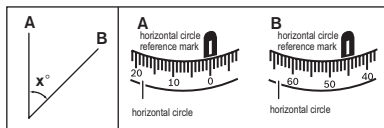

fig.7

5. Checking and Adjusting

Before using the instrument or after long transportation, the leveling accuracy and indication accuracy.

5.1 Check Circular Bubble Vial

1. Adjust the instrument with leveling screw knob 9, so that the air bubble is in the center of circular vial.
2. Rotate the unit by 180° , the air bubble should keep in center, if the air bubble moves out of center, the circular bubble vial must be readjusted.

5.2 Adjusting Circular Bubble Vial

1. Rotate the leveling screw knob 9 to ensure the air bubble moving toward to the center of circular bubble vial, the deviation should be at $1/2$ between the center and the end position(see fig.8)
2. Use align wrench turn the two adjustment screws till the air bubble moving to the center of circular bubble vial.(see fig.9)
3. Repeat the above step till the air bubble keep in the center of circular bubble vial no matter which direction the telescope turned.

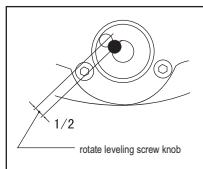

fig.8

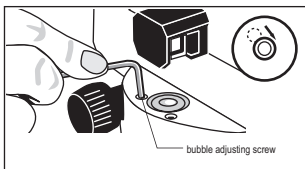

fig.9

5.3 Checking i angle

1. Checking should be done at a distance of 30m. Place the instrument in the center of this distance, put 2 leveling rod at the both end of measuring distance A and B separately. (see fig.10)
2. Read off the heights of this two leveling rod, calculate the difference d ; that is the difference between a_1 (the height of leveling rod A) and b_1 (the height of leveling rod B).

Example: $a_1=1.937\text{m}$ $b_1=1.689\text{m}$ so $a_1-b_1=0.248=d$

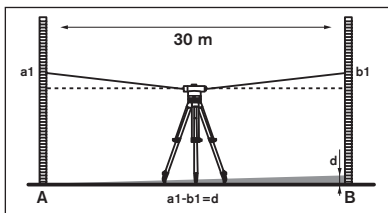

Fig.10

- Place the instrument to the position of 1m away from leveling rod A, read height a_2 (the height of leveling rod A)
- Calculate $b_2'=a_2-d$, then record the height b_2 (the height of leveling rod B), if the deviates value between b_2' and b_2 over 6mm (20x/22x) or 3mm(24x/26x/28x/32x), the crosshair must be readjusted.

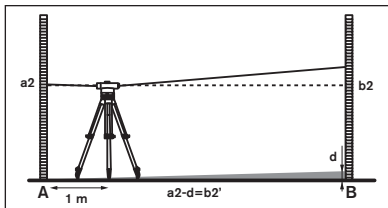

Fig.11

Example: $a_2=1.724\text{m}$ $d=0.248$ so $a_2-d=1.476=b_2'$

when measuring 20x/22x, the height b_2 should be $1.476\text{m} \pm 6\text{mm}$

when measuring 24/26/28/32x, the height b_2 should be $1.476 \pm 3\text{mm}$

5.4 adjust the i angle

take off the eyepiece cover, use adjusting pin turn adjusting screw clockwise or counterclockwise till the heights value b_2 and b_2' on leveling rod B are same. Screw on eyepiece cover again.

6. Maintenance and Service

Carefully use and maintain the unit, can guarantee the instrument accuracy and efficiency.

1. After measuring, wipe clean all the surface of the instrument and put into the carrying case.
2. Dust all optical parts with a soft brush and clean the lens with lens paper. Never touch the lens with your fingers.
3. If the instrument failed in function or damaged, repair or check should be done by experienced technician who fully understand the unit structure or returned to the factory for repair. Do not open the instrument by yourself.
4. A bag of silica gel dryer is included in the case for the removal of residual moisture. Renew the bag of silica gel regularly.
5. The unit should be kept in a dry, clean, dust-free and air-flow condition with low humidity.

7. Packing List

Plastic Carrying Case.	1
The Unit	1
Adjusting Pin.	1
Hexagonal Wrench	1
Instruction Manual.	1
Plumb.	1
Silica Dry Gel.	1

Note: 400gon、5/8" tripod only for export purpose

